

L1 PRO32 + SUB1

PORTABLE LINE ARRAY SYSTEM



Product Overview

The L1 Pro32 is our most advanced Bose L1 portable line array ever. It delivers the supreme clarity and output of a 32-driver articulated line array and 180-degree horizontal sound coverage, giving you an unrivaled portable PA system for medium-to-large-sized venues and events like weddings, clubs, and festivals. The L1 Pro32 combines with either the Bose Sub1 or Sub2 subwoofer to create a powerful, modular solution that's easy to pack, carry, and set up. A built-in multi-channel mixer offers EQ, reverb, and phantom power, plus *Bluetooth*[®] streaming and access to the full library of ToneMatch presets — and the intuitive L1 Mix app places wireless control in your hands from your smartphone.

For DJs, singer-songwriters, bands — and your audience — the L1 Pro32 offers a truly superior experience. It gives you the power to sound your best and simply perform.

Key Features

Provide a truly superior audio experience with the most advanced L1 portable line array ever, ideal for medium-to-large-sized venues and events like weddings, clubs, and festivals

Deliver premium full-range sound with consistent tonal balance for singer-songwriters, mobile DJs, bands, and more

Maintain supreme vocal and instrument clarity with a straight-shape extended-frequency line array featuring 32 articulated 2" neodymium drivers and wide 180-degree horizontal coverage

Bring bass without the bulk via Bose Sub1 or Sub2 modular subwoofers, featuring RaceTrack drivers that take up less space, freeing up room in your vehicle and on the stage

Go from vehicle to venue easily with a modular high-output system that's lighter and easier to pack, carry, and set up

Select between optimized system EQ presets for live music, recorded music, and more

Connect various audio sources easily via built-in mixer with two combo XLR- $\frac{1}{4}$ " phantom-powered inputs, $\frac{1}{4}$ " and $\frac{1}{8}$ " (3.5 mm) aux input, plus *Bluetooth*[®] streaming — and access system EQ and ToneMatch presets, volume, tone, and reverb via illuminated controls

Add even more instruments and other audio sources via dedicated ToneMatch port; one cable provides both power and digital audio between system and a Bose T4S or T8S mixer (optional)

Take wireless control with the L1 Mix app on your smartphone to adjust settings instantly, roam the room and fine-tune, and access the ToneMatch library of custom EQ presets

Stream high-quality *Bluetooth*[®] audio from compatible devices

Technical Specifications

System Performance	
Model Name	L1 Pro32 + Sub1
System Type	Self-powered line array with modular bass module and onboard three-channel digital mixer
Frequency Response (-3 dB) ¹	40 Hz to 16 kHz
Frequency Range (-10 dB)	32 Hz to 18 kHz
Nominal Vertical Coverage Pattern	0°
Vertical Beam Type	Straight-shape
Nominal Horizontal Coverage Pattern	180°
Calculated Maximum SPL @ 1 m, continuous ²	117 dB
Calculated Maximum SPL @ 1 m, peak ²	123 dB
Crossover	200 Hz
Transducers	
Low Frequency	1 × RaceTrack low-frequency driver 7" × 13"
Low Frequency Voice Coil Size	2"
High / Mid Frequency	32 × Articulated 2" drivers
High / Mid Frequency Voice Coil Size	¾"
Driver Protection	Dynamic limiting
Amplification	
Type	Two-channel, Class D
Low Frequency Amp Channel	480 W
High / Mid Frequency Amp Channel	480 W
Cooling	L1 Pro32: Fan-assisted cooling Sub1: Convection cooling
Onboard Mixer	
Channels	Three
Channel 1 & 2 Input: Audio Type	Combination XLR or ¼" TRS connector (mic/instrument/line)
Channel 1 & 2 Input: Input Impedance	10 KΩ (XLR); 2 MΩ (TRS)
Channel 1 & 2 Input: Trim	0 dB, 12 dB, 24 dB, 36 dB, and 45 dB analog gain steps automatically selected and compensated by DSP
Channel 1 & 2 Input: Channel Gain	-100 dB to +75 dB (XLR); -115 dB to +60 dB (TRS); from input to driver, controlled by volume knob
Channel 1 & 2 Input: Max Input Signal	+10 dBu (XLR); +24 dBu (TRS)
Channel 3 Input: Audio Type	⅛" TRS (stereo-summed, line), ¼" TRS (line), <i>Bluetooth</i> [®] audio streaming
Channel 3 Input: Input Impedance	40 KΩ (3.5 mm); 200 KΩ (TRS)
Channel 3 Input: Channel Gain	-105 dB to +50 dB (3.5 mm); -115 dB to +40 dB (TRS); from input to driver, controlled by volume knob
Channel 3 Input: Max Input Signal	+11.7 dBu (3.5 mm); +24 dBu (TRS)
ToneMatch: Audio Type	RJ-45 connector for ToneMatch cable connection, providing digital audio and power connection for the optional T4S/T8S ToneMatch Mixer
Output: Audio Type	XLR connector, line level, full-frequency bandwidth
<i>Bluetooth</i> Enabled	Yes
<i>Bluetooth</i> Types	AAC and SBC for audio streaming, LE for system control
Channel Controls	3 digital rotary encoders
Phantom Power	Channel 1 & 2
LED Indicators	Standby, Channel Parameters, Signal/Clip, Mute, Phantom Power, ToneMatch, <i>Bluetooth</i> LED, System EQ

Technical Specifications

AC Power	
AC Power Input	100-240 VAC ($\pm 20\%$, 50/60 Hz)
Input: Electrical Type	IEC
Initial turn on inrush current	L1 Pro32: 15.3 A at 120 V; 29.0 A at 230 V
	Sub1: 14.9 A at 120 V; 29.3 A at 230 V
Inrush current after AC mains interruption of 5 s	L1 Pro32: 1.2 A at 120 V; 26.5 A at 230 V
	Sub1: 5.8 A at 120 V; 32.0 A at 230 V
Enclosure	
Color	Black
Enclosures Material	L1 Pro32: Power stand: High-impact polypropylene Arrays: High-impact ABS
	Sub1: High-impact polypropylene, birch plywood
Product Dimensions (H x W x D)	L1 Pro32: 2120 x 351 x 573 mm (83.5 x 13.8 x 22.5 in)
	Sub1: 533 x 260 x 529 mm (21.0 x 10.2 x 20.8 in)
Shipping Dimensions (H x W x D)	L1 Pro32: 220 x 450 x 1200 mm (8.66 x 17.72 x 47.24 in)
	Sub1: 620 x 620 x 330 mm (24.41 x 24.41 x 12.99 in)
Net Weight ³	L1 Pro32: 13.1 kg (28.9 lbs)
	Sub1: 15.5 kg (34.1 lbs)
Shipping Weight	L1 Pro32: 19.0 kg (41.9 lbs)
	Sub1: 18.0 kg (39.7 lbs)
Included Accessories	Carry bag for arrays, carry bag for power stand, SubMatch cable, IEC power cord (2), bass module slip cover
Optional Accessories	L1 Pro32 Array & Power Stand Bag, Sub1 Roller Bag, Adjustable Speaker Pole, SubMatch Cable
Warranty Period	2 years
Product Part Numbers	
840921-1100	L1 PRO32 PORTABLE LINE ARRAY,120V,US
840921-2100	L1 PRO32 PORTABLE LINE ARRAY,230V,EU
840921-3100	L1 PRO32 PORTABLE LINE ARRAY,100V,JP
840921-4100	L1 PRO32 PORTABLE LINE ARRAY,230V,UK
840921-5100	L1 PRO32 PORTABLE LINE ARRAY,230V,AU
840921-5130	L1 PRO32 PORTABLE LINE ARRAY,230V,INDIA
840918-1100	SUB1 POWERED BASS MODULE,120V,US
840918-2100	SUB1 POWERED BASS MODULE,230V,EU
840918-3100	SUB1 POWERED BASS MODULE,100V,JP
840918-4100	SUB1 POWERED BASS MODULE,230V,UK
840918-5100	SUB1 POWERED BASS MODULE,230V,AU
840918-5130	SUB1 POWERED BASS MODULE,230V,INDIA
856996-0110	PREMIUM CARRY BAG,L1 PRO32,BLACK
856985-0110	PREMIUM ROLLER BAG,SUB1,BLACK
857172-0110	SUBMATCH CABLE,BLACK
857000-0110	SPEAKER STAND,SUB POLE,BLACK
845116-0010	TONEMATCH CABLE ASSY KIT 18FT

Footnotes

- (1) Frequency response and range measured on-axis in anechoic environment with recommended bandpass and EQ.
(2) Maximum SPL calculated using sensitivity and power ratings, exclusive of power compression.
(3) Net weight excludes carry bags, slip cover, SubMatch cable, and power cords.

Connections and Controls

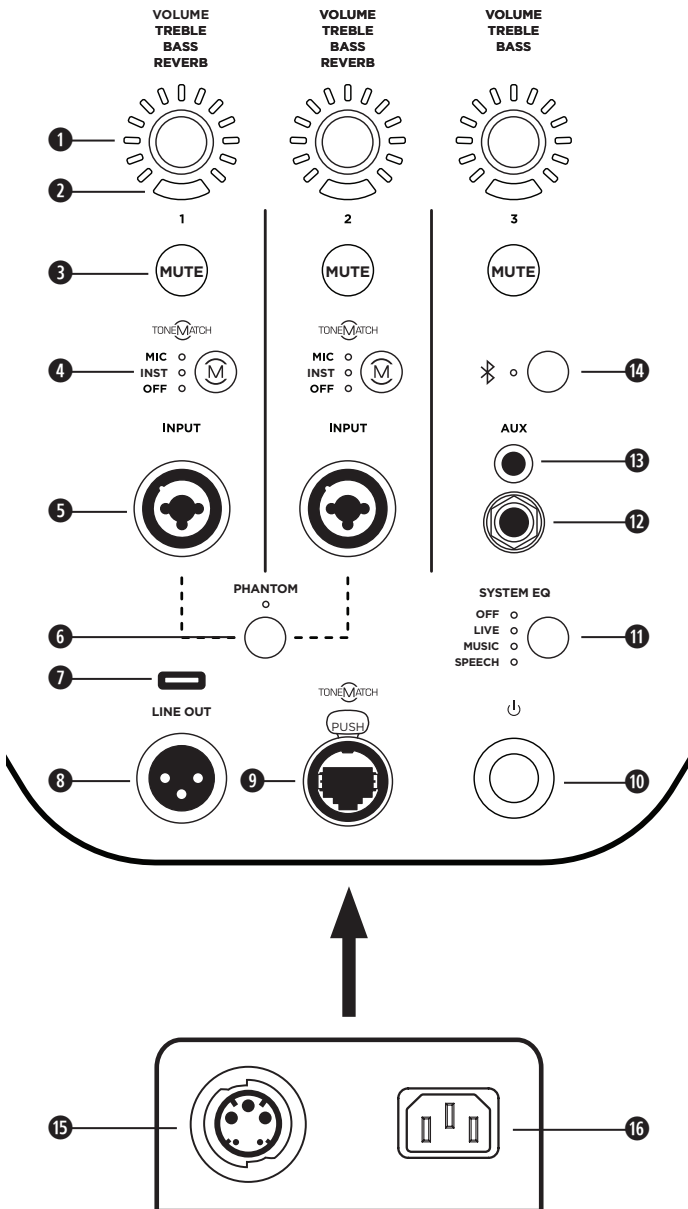

- 1 **Channel Parameter Control:** Adjust the level of volume, treble, bass, or reverb for your desired channel. Press the control to switch between parameters; rotate the control to adjust the level of your selected parameter.
 - 2 **Signal/Clip Indicator:** The LED will illuminate green when a signal is present and will illuminate red when the signal is clipping or the L1 Pro is entering limiting. Reduce the channel or signal volume to prevent signal clipping or limiting.
 - 3 **Channel Mute:** Mute the output of an individual channel. Press the button to mute the channel. While muted, the button will illuminate white.
 - 4 **Channel ToneMatch Button:** Select the ToneMatch preset for an individual channel. Use **MIC** for microphones and use **INST** for acoustic guitar. The corresponding LED will illuminate white while selected.
 - 5 **Channel Input:** Analog input for connecting microphone (XLR), instrument (TS unbalanced), or line level (TRS balanced) cables.
 - 6 **Phantom Power:** Press the button to apply 48-volt power to Channels 1 and 2. The LED will illuminate white while phantom power is applied.
 - 7 **USB Port:** USB-C connector for Bose service use. **Note:** This port is not compatible with Thunderbolt 3 cables.
 - 8 **XLR Line Output:** Use an XLR cable to connect the line-level output to a Sub1/Sub2 or another bass module.
 - 9 **ToneMatch Port:** Connect your L1 Pro to a T4S or T8S ToneMatch mixer via a ToneMatch cable.
- CAUTION:** Do not connect to a computer or phone network.
- 10 **Standby Button:** Press the button to power on the L1 Pro. The LED will illuminate white while the L1 Pro is on.
 - 11 **System EQ:** Press the button to scroll through and select a master EQ suitable for the use case. The corresponding LED will illuminate white while selected.
 - 12 **TRS Line Input:** Use a 6.4-millimeter (¼-inch) TRS cable to connect line-level audio sources.
 - 13 **Aux Line Input:** Use a 3.5-millimeter (⅛-inch) TRS cable to connect line-level audio sources.
 - 14 **Bluetooth® Pair Button:** Set up pairing with Bluetooth capable devices. The LED will flash blue while the L1 Pro is discoverable and illuminate solid white when a device is paired for streaming.
 - 15 **SubMatch Output:** Connect a Sub1/Sub2 bass module with a SubMatch cable.
 - 16 **Power Input:** IEC power cord connection.

Connections and Controls

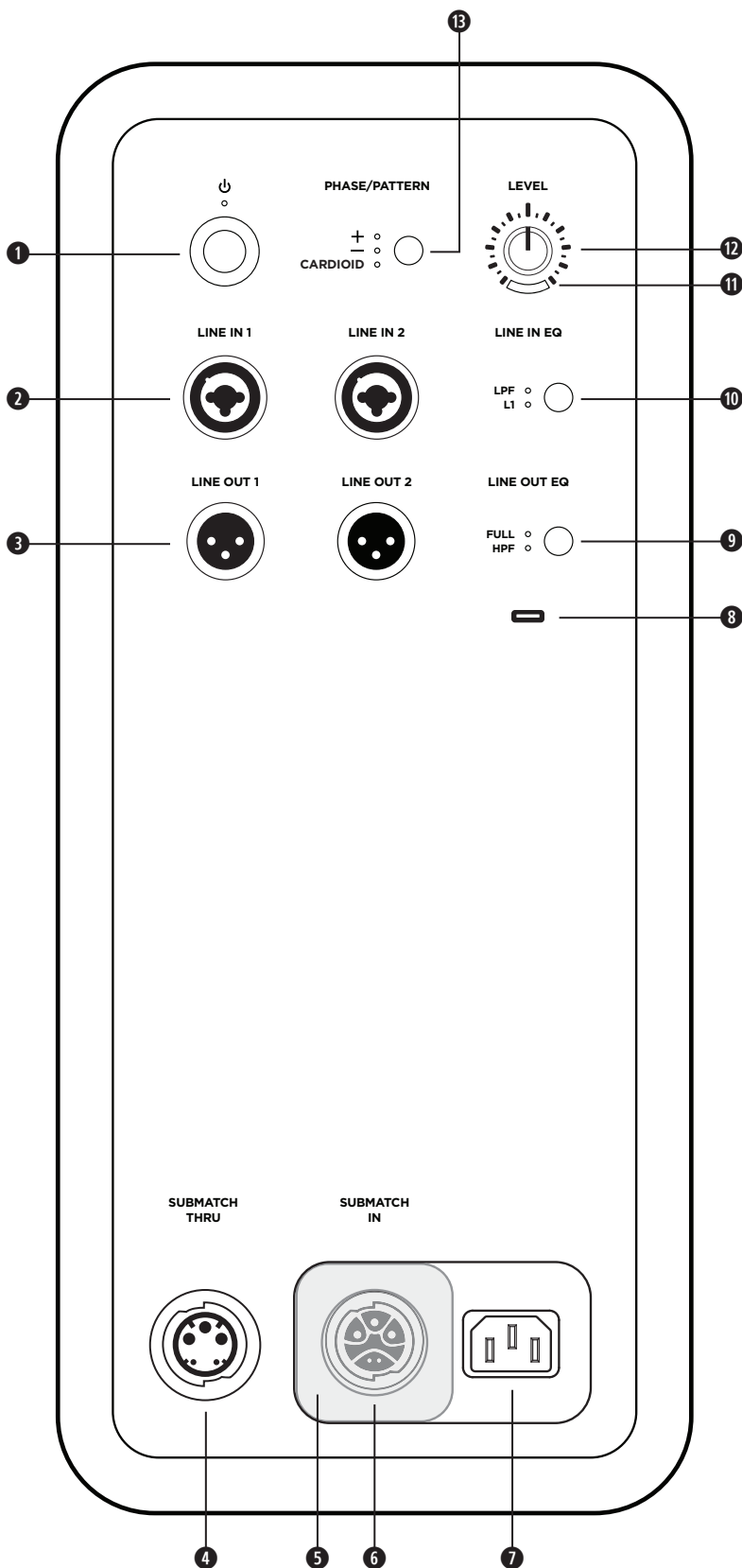

- 1 Standby Button:** Press the button to power on the Sub. The LED will illuminate white while the Sub is on.
- 2 Line Inputs:** Analog input for connecting an L1 Pro or other line-level audio source. Compatible with XLR, TRS balanced, and TS unbalanced cables.
- 3 Line Outputs:** Use an XLR cable to connect the line-level output to a loudspeaker.
- 4 SubMatch ThruPut:** Connect an additional Sub bass module with a SubMatch cable. Up to two Sub1 or Sub2 powered bass modules can be powered by a single L1 Pro32 via SubMatch connection.
- 5 Power Input Cover:** Prevents simultaneous use of the **SubMatch Input** and **Power Input**. Slide the cover to reveal the power input that is needed for setup.
- 6 SubMatch Input:** Connect the Sub to an L1 Pro32 with a SubMatch cable.
- 7 Power Input:** IEC power cord connection.
- 8 USB Port:** USB-C connector for Bose service use and firmware updates.
Note: This port is not compatible with Thunderbolt 3 cables.
- 9 Line Output EQ:** Select between **FULL** bandwidth or a multi-purpose HPF when using **Line Outputs**. Press the button to switch EQ settings. The corresponding LED will illuminate white while selected.
- 10 Line Input EQ:** Select between an optimized EQ for an L1 Pro or a multi-purpose LPF when using **Line Inputs**. Press the button to switch EQ settings. The corresponding LED will illuminate white while selected.
- 11 Signal/Clip Indicator:** The LED will illuminate green when a signal is present and will illuminate red when the signal is clipping or the Sub is entering limiting. Reduce the level or signal volume to prevent signal clipping or limiting.
- 12 Level Control:** Adjust the level of audio output. The **Level Control** does not affect the **Line Outputs**. The 12 o'clock position is recommended when in use with an L1 Pro32.
- 13 Phase/Pattern Button:** Adjust the polarity of the Sub. Press the button to switch polarity. The corresponding LED will illuminate white while selected. Also allows access to Cardioid mode when using two identical Sub modules.

Product Dimensions

Modular View

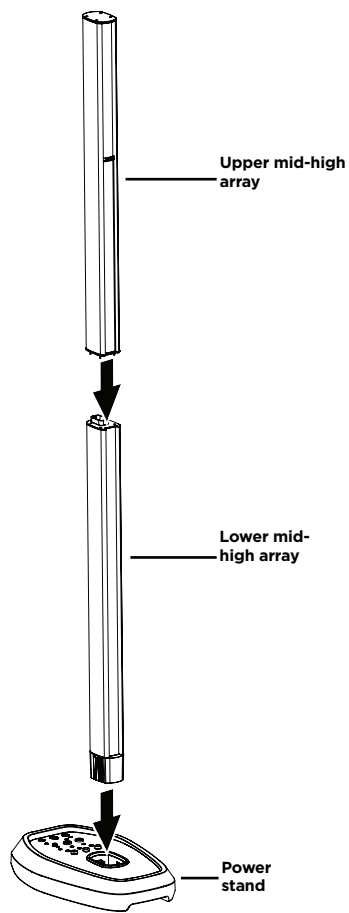

Front View

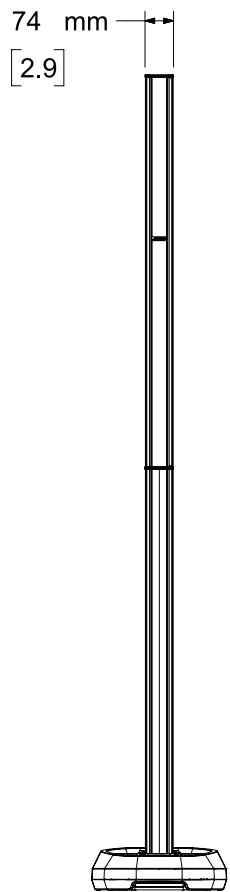

Side View

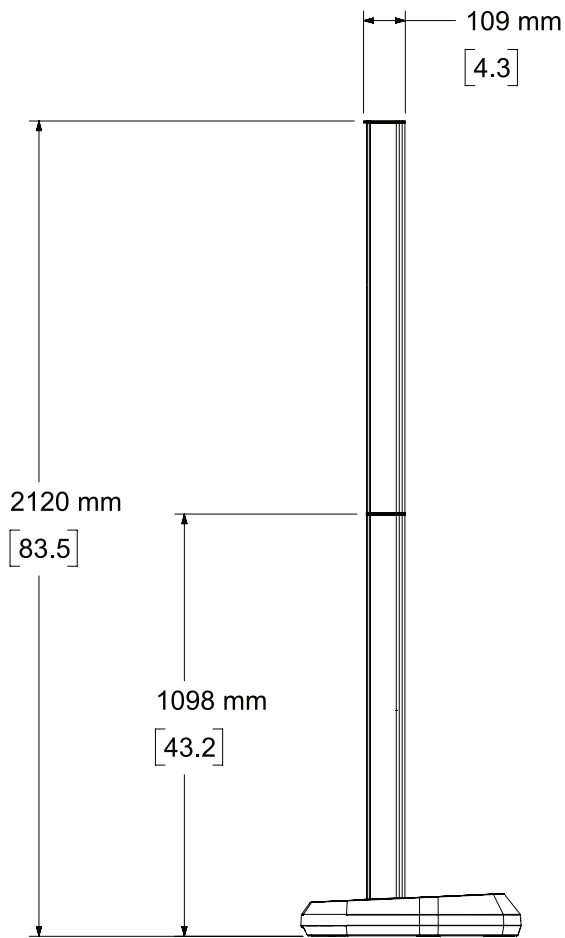

Rear View

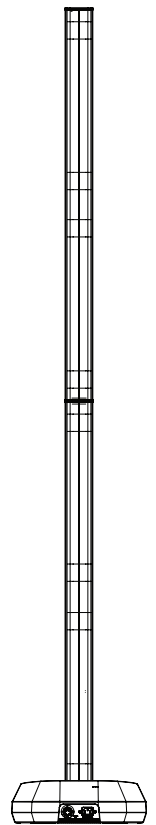

Top View

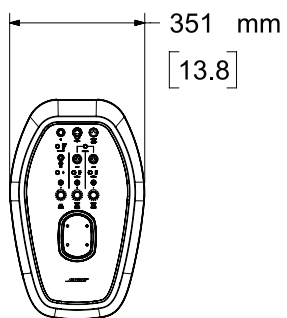

Bottom View

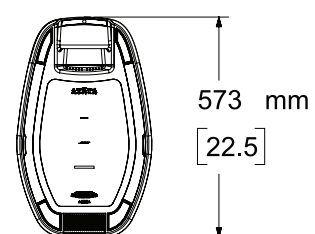

Product Dimensions

Left View

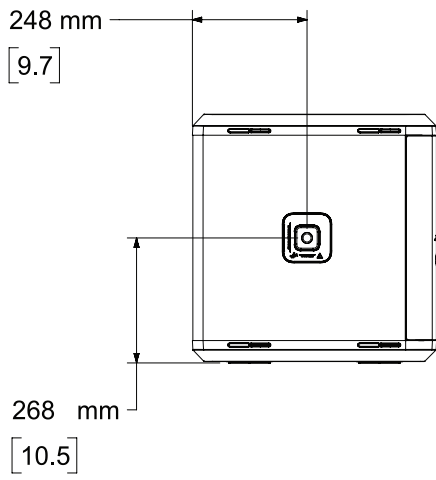

Front View

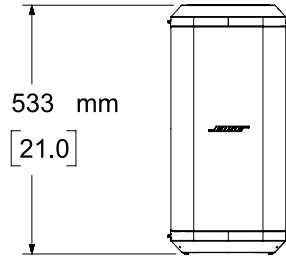

Right View

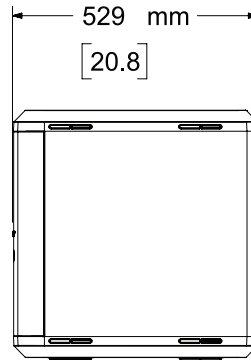

Rear View

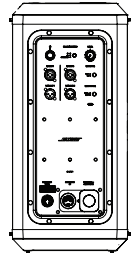

Bottom View

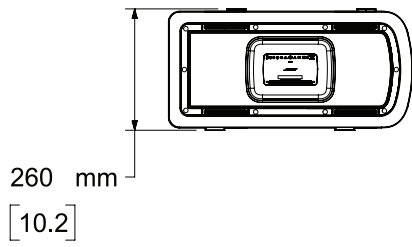

Top View

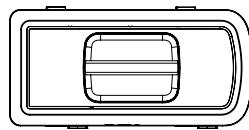

Performance

Frequency Response (On-Axis)

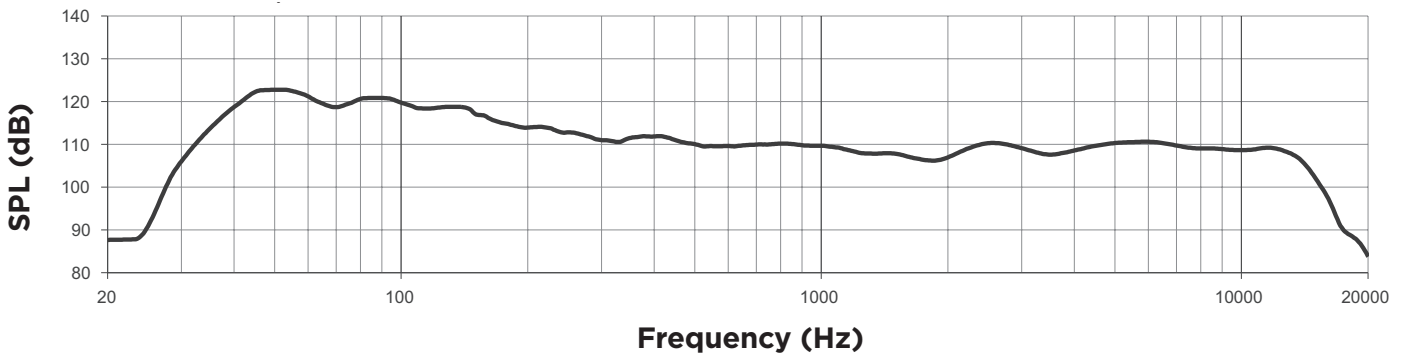

Directivity Index and Q

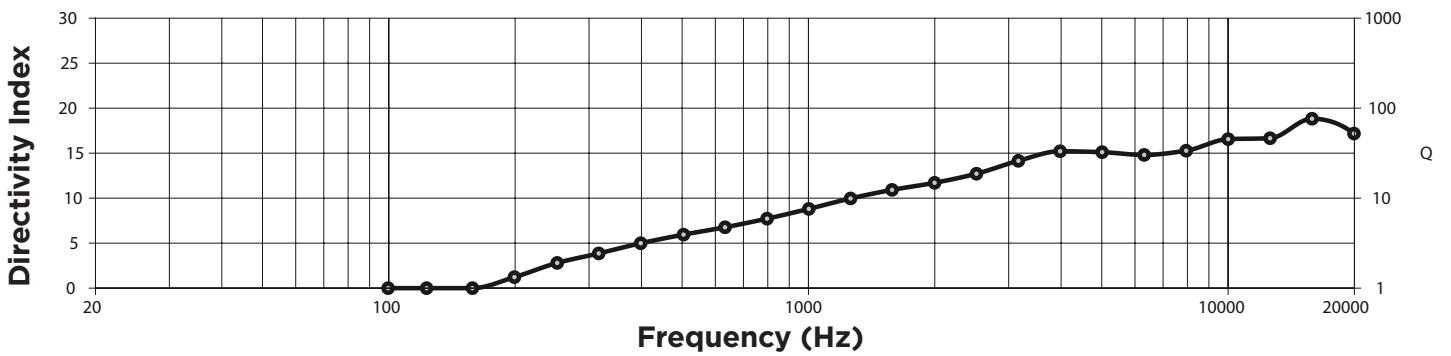

Beamwidth

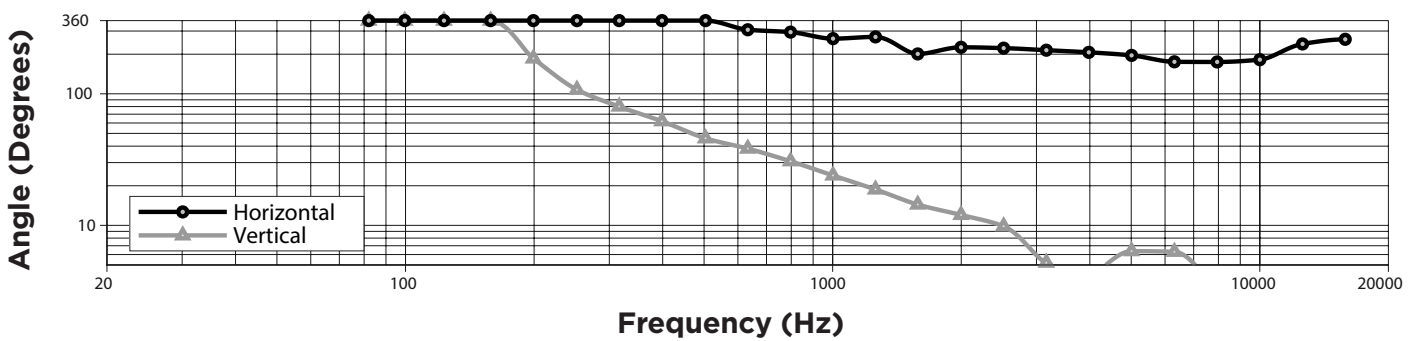

Architect and Engineer Specification

The system shall be a multiple-driver, full-range portable loudspeaker system with internally-supplied power amplification and active equalization for multiple operating modes as follows:

The transducer complement shall consist of 32, 2" (51 mm) high-excursion cricket drivers mounted in a curved articulated array loudspeaker, coupled with a modular 7" x 13" (177 mm x 330 mm) RaceTrack low-frequency driver mounted in a ported bass enclosure. The loudspeaker array shall be wired in a series/parallel configuration.

The nominal horizontal beamwidth of the loudspeaker shall be 180° and the nominal vertical coverage shall be 0°. The system's power stand shall incorporate a ported venting system for the low-frequency driver. The power amplification for transducers shall be supplied by an integral two-channel onboard amplifier providing 480 W for low-frequency transducers (Sub1) and 480 W for high-mid array transducers (L1 Pro32).

The onboard digital mixer shall consist of three input channels. Channel 1 and 2 shall provide a combination XLR or ¼" TRS connector (mic/instrument/line) with treble, bass equalization, and reverb effects. Phantom power (48 V) shall be available via a push button to enable and disable. Both channels shall provide selectable equalization presets for microphone and instruments. Channel 3 shall provide a ⅛" TRS (stereo-summed, line) connector, ¼" TRS (line) connector. The same channel shall provide *Bluetooth*® audio streaming using a high-definition AAC codec with a *Bluetooth* pairing button provided. All three channels shall have a dedicated channel mute button. The output connector of the onboard mixer shall consist of one XLR balanced line-level output connector. The onboard mixer shall provide a ToneMatch RJ-45 connector to receive digital audio and send power via ToneMatch cable for Bose T4S/T8S ToneMatch mixer.

The enclosure of the power stand shall be constructed of high-impact polypropylene. The arrays shall be constructed of high-impact ABS. The subwoofer shall be constructed of high-impact polypropylene and birch plywood.

The system's array outer dimensions shall be 83.5" H x 13.8" W x 22.5" D (2120 mm x 351 mm x 573 mm). Its net weight shall be 28.9 lbs (13.1 kg). The system's subwoofer dimensions shall be 21.0" H x 10.2" W x 20.8" D (533 mm x 260 mm x 529 mm). Its net weight shall be 34.1 lbs (15.5 kg).

The loudspeaker shall be the Bose L1 Pro32 + Sub1 portable line array system.

Safety and Regulatory Compliance

The L1 Pro32 + Sub1 portable line array system complies with the following standards:

- UL/IEC/EN62368-1 Audio/Video, Information and Communication Technology Equipment
- Ecodesign Requirements for Energy Related Products Directive 2009/125/EC
- Radio Equipment Directive 2014/53/EU
- CAN ICES-3 (B)/NMB-3(B)
- FCC Part 15 Class B

The *Bluetooth*® word mark and logos are registered trademarks owned by Bluetooth SIG, Inc. and any use of such marks by Bose Corporation is under license. Bose, L1, and ToneMatch are trademarks of Bose Corporation. All other trademarks are the property of their respective owners.