



Admin and Installation Guide  
v1.05

# Snom M700, Snom M300

Base stations

## TABLE OF CONTENTS

<b>Copyright, Trademarks, Legal Disclaimers .....</b>	<b>5</b>
<b>Important Information .....</b>	<b>6</b>
Suitable and Unsuitable Locations .....	6
Intended Use .....	6
Safety Precautions .....	6
Cleaning .....	8
Disposal .....	9
Standards Conformance .....	9
M700 .....	9
M300 .....	9
Additional Important Information USA .....	10
FCC and Other Information .....	12
Regulatory Information Canada .....	14
<b>Introduction .....</b>	<b>15</b>
<b>Setting Up .....</b>	<b>16</b>
M700 .....	16
Power Sourcing .....	16
Hardware Setup .....	16
Standing Unit .....	16
Wall or Ceiling Mounting .....	17
User Interface of the Unit .....	20
LED Status Indicator .....	20
Reset Key .....	20
M300.....	21
Hardware Setup .....	21
Standing Unit .....	21
Wall Mounting .....	21
User Interface of the Unit .....	23
LED Status Indicator .....	23
Reset Key .....	23
<b>Configuring .....</b>	<b>24</b>
Preliminary Steps .....	24
Finding the IP Address of the Base Station .....	24
Opening the Web User Interface .....	25
Initial Settings .....	26
Servers .....	26
Language, Country, and Time/Date .....	26
Extensions - M700 .....	27
Setting up Extensions - M700 .....	27
Registering Handsets on M700 - Method 1 .....	28

Registering Handsets on M700 - Method 2 .....	29
Selecting Emergency Alarm Setting on M700 .....	31
Deregistering/Deleting Handsets and/or SIP Registrations on M700 .....	31
Extensions - M300 .....	32
Setting up extension and handset on M300 .....	32
Selecting Multiple Handsets for an Extension .....	34
Selecting Emergency Alarm Setting on M300 .....	35
Deleting Handset on M300 .....	36
Deregistering SIP Registrations on M300 .....	36
Registering M5 repeaters .....	37
Automatic registration .....	37
Manual registration .....	39
Emergency alarm .....	41
<b>Central Directory .....</b>	<b>42</b>
Local Phone Directory .....	42
Preparing the Phone Directory File .....	42
Downloading the Phone Directory File .....	45
LDAP .....	46
<b>Firmware Update .....</b>	<b>47</b>
Considerations before updating .....	47
Updating manually .....	47
Using Snom's update server .....	48
Using your own server .....	48
Downloading update files to your server .....	48
Downloading update files to base station and transmitting to wireless devices .....	49
Updating the base station .....	50
Updating registered handsets .....	50
Provisioning updates .....	50
<b>Description of Settings .....</b>	<b>51</b>
Home/Status .....	51
Extensions .....	53
M700 .....	53
Extensions page settings .....	53
Add/Edit Extension settings .....	54
Handset settings .....	56
M300 .....	57
Extensions and Handset page settings .....	57
Add/Edit Extension settings .....	58
Handset settings .....	59
Servers .....	61
Network .....	65
Management .....	67
Firmware Update .....	69

Time .....	70
Country .....	72
Security .....	73
Central Directory .....	75
Multicell .....	77
Repeaters .....	81
Alarm .....	82
Statistics .....	83
Configuration .....	84
Syslog .....	84
SIP Log .....	84

# Copyright, Trademarks, Legal Disclaimers

© 2016 Snom Technology Aktiengesellschaft. All Rights Reserved.

Snom, the names of Snom products, and Snom logos are trademarks owned by Snom Technology AG. All other product names and names of enterprises are the property of their respective owners.

Product specifications are subject to change without notice.

Snom Technology AG reserves the right to revise and change this document at any time, without being obliged to announce such revisions or changes beforehand or after the fact.

Texts, images, and illustrations and their arrangement in this document are subject to the protection of copyrights and other legal rights worldwide. Their use, reproduction, and transmittal to third parties without express written permission may result in legal proceedings in the criminal courts as well as civil courts.

When this document is made available on Snom's web page, Snom Technology AG gives its permission to download and print copies of its content for the intended purpose of using it as a manual. No parts of this document may be altered, modified or used for commercial purposes without the express written consent of Snom Technology AG.

Although due care has been taken in the compilation and presentation of the information in this document, the data upon which it is based may have changed in the meantime. Snom therefore disclaims all warranties and liability for the accurateness, completeness, and currentness of the information published, except in the case of intention or gross negligence on the part of Snom or where liability arises due to binding legal provisions.

# Important Information

## Suitable and Unsuitable Locations

Please read the precautions and instructions on how to install the product thoroughly.

- The product is for indoor installation only. Not for outdoor installation!
- The operational temperature for the product is between -10°C and + 50°C (14°F and 122°F).
- The maximum humidity for the product is 70% noncondensing. Do not install product in rooms with high humidity (for example, in bathrooms, laundry rooms, damp basements).
- Do not install the product in locations where it may get splashed with water or chemicals.
- Do not install the product in surroundings at risk for explosions and do not use the product in such surroundings (paint shops, for example).
- Do not install the product near air conditioners or air conditioning vents, radiators, in very dusty surroundings, or where it is exposed to direct sunlight.
- Avoid placing the device's Ethernet cable where people may trip over it. Avoid placing the cable where it may be exposed to mechanical pressure as this may damage it. If the cable is damaged, disconnect the device and contact qualified service personnel.
- Proximity to metal surfaces, electric current lines, and water pipes might degrade signal reception/transmission. We recommend to not install the product directly on metal surfaces and to maintain a minimum distance of 20 cm (8 Inches) from electric current lines and water pipes.
- Medical devices might be adversely affected. Please consider the technical ramifications when installing the device in a doctor's office, for example.
- Install the product at a minimum distance of 100 cm (39") to persons and animals.

## Intended Use

This product is designed for use with a Snom M-series telephone. Any other use is considered unintended use. Any modification or reconstruction not described in the user manual is considered unintended use.

## Safety Precautions

Please read these precautions and the instructions on how to set up and use the device thoroughly before using it. Save this info sheet and do not give the device to third parties without it. Please also note the information on the proper disposal of the device.

- Avoid placing the device's Ethernet cable and power cord (M300 only) where people may trip over them. Avoid placing the cable where it may be exposed to mechanical pressure as this may damage it. If the power cord (M300) is damaged, disconnect the device and contact qualified service personnel.
- The product is for indoor installation only. Not for outdoor installation!

- The operational temperature for the product is between -10°C and + 50°C (14°F and 122°F).
- Do not install product in rooms with high humidity (for example, in bathrooms, laundry rooms, damp basements). Do not immerse product in water and do not spill or pour liquids of any kind onto or into any parts of it.
- Do not install product in surroundings at risk for explosions and do not use the product in such surroundings (paint shops, for example). Do not use the product if you smell gas or other potentially explosive fumes!
- Install the product at a minimum distance of 100 cm (39") to persons and animals.
- Medical devices might be adversely affected. Please consider the technical ramifications when installing the device in a doctor's office, for example.
- FOR THE USA: Do not use near medical equipment or if you have a pacemaker.

#### **If you have an implanted pacemaker**

- Do not use if you have an implanted pacemaker unless the pacemaker manufacturer's directions expressly permit the use of devices emitting pulsating radio frequency signals. Always follow the manufacturer's directions!
- Recommended MINIMUM distance to the device: 100 cm (39").
- Turn the device off immediately if there is any reason to suspect that interference is taking place.
- FOR THE USA: Do not use if you have a pacemaker.

## **Additional safety information**

### **Small children**

Your device and its enhancements may contain small parts. Keep them out of the reach of small children.

### **Operating environment**

Remember to follow any special regulations in force in any area, and always switch off your device when its use is prohibited or when it may cause interference or danger. Use the device only in its normal operating positions. Do not place credit cards or other magnetic storage media near the device, because information stored on them may be erased.

### **Medical devices**

Operation of any equipment emitting radio frequency signals may interfere with the functionality of inadequately shielded medical devices. Consult a physician or the manufacturer of the medical device to determine if they are adequately shielded from external radio frequency (RF) energy or if you have any other questions concerning this topic. Switch off your device in health care facilities when signs posted in these areas instruct you to do so. Hospitals or health care facilities may be using equipment that could be sensitive to external RF energy.

## Implanted medical devices

Manufacturers of medical devices recommend that a minimum distance should be maintained between a wireless device and an implanted medical device, such as pacemakers or cardioverter defibrillators, to avoid potential interference with the medical device. Persons who have such devices should:

- Always keep the wireless device more than 100 centimeters (39 inches) from the medical device when the wireless device is turned on.
- Not carry the wireless device in a breast pocket.
- Hold the wireless device to the ear opposite the medical device to minimize the potential for interference.
- Turn the wireless device off immediately if there is any reason to suspect that interference is taking place.
- Read and follow the directions of the medical device's manufacturer.
- If you have any questions about using your wireless device with an implanted medical device, consult your health care provider.

## SELV (Safety Extra Low Voltage) Compliance

Safety status of Input/Output connections comply with SELV requirements.

## Potentially explosive environments

Switch off your device when in any area with a potentially explosive atmosphere and obey all signs and instructions. Sparks in such areas could cause an explosion or fire resulting in bodily injury or even death. Switch off the device at refuelling points such as near gas pumps at service stations. Observe restrictions on the use of radio equipment in fuel depots, storage, and distribution areas; chemical plants; or where blasting operations are in progress. Areas with a potentially explosive atmosphere are often but not always clearly marked. They include below deck on boats, chemical transfer or storage facilities, vehicles using liquefied petroleum gas, and areas where the air contains chemicals or particles such as grain dust or metal powders.

## Sensitive Electronic Equipment

The current state of research concludes that operational DECT phones normally do not adversely affect electronic equipment. Nevertheless, you should take some precautions if you want to operate DECT phones in the immediate vicinity of such equipment like sensitive laboratory equipment. Always keep a minimum distance of 10 cm (3.94") to the equipment even when the phone is in standby.

## Electrical Surges

We recommend the installment of an AC surge arrester in the AC outlet to which this device is connected to avoid damage to the equipment caused by local strikes of lightning or other electrical surges.

## Cleaning

Use an anti-static cloth. Please avoid water and liquid or solid cleaning products as they might damage the surface or internal electronics of the base, charger, and handset.



## Disposal



This product is subject to European Directive 2012/19/EU and may not be disposed of with general household garbage.

If you do not know where you may dispose of the device at the end of its lifespan, contact your municipality, your local waste management provider, or your seller.

## For countries outside the European Union

Disposal of electrical and electronic products in countries outside the European Union should be done in line with local regulations. Please contact local authorities for further information.

## Standards Conformance



This device complies with the essential health, safety, and environmental requirements of all relevant European directives.



This device is FCC certified and meets US health, safety, and environmental standards.

Unauthorized opening, changing, or modifying the device will cause the warranty to lapse and may also result in the loss of CE conformity and the FCC certification. In case of malfunction contact authorized service personnel, your seller, or Snom.

The declarations of conformity can be requested from

Snom Technology AG  
Wittestr. 30G  
13509 Berlin, Germany

## M700

- **Safety:** IEC 60950-1:2005
- **Connector:** RJ45 (8P8C)
- **Power over Ethernet (PoE):** IEEE 802.3af, Class 2

## M300

- **Safety:** IEC 60950-1:2005
- **Ethernet connector:** RJ45 (8P8C)
- **Power:** Power adapter 5V DC 600 mA
  - EU: Ten Pao SMPS adapter, model no. S003GV0500060, input 100-240 VAC, output 5V DC 600 mA, coaxial power connector
  - US: Ten Pao SMPS adapter, model no. S003GU0500060, input 100-240 VAC, output 5V DC 600 mA, coaxial power connector
  - AU: Ten Pao SMPS adapter, model no. S003GS0500060, input 100-240 VAC, output 5V DC 600 mA, coaxial power connector

## Additional Important Information USA

### FCC ID:

- M700: T7HX8660
- M300: T7HX9430

### Intended Use

This device is designed for use with Snom M-series phones. Any other use, modification or reconstruction of the product is considered unintended use.

### Important Safety Information

Follow all instructions and warnings in the user manual, and on the equipment to prevent accidents.

### WARNING

Fire, electric shock, or other injury may result if you do not observe the following safety precautions:

- Do not use in or near a bathtub, sink, swimming pool, wet basement, or other water.
- Do not use this or any cordless telephone in the vicinity of a gas leak.
- Do not use in environments subject to explosion hazards, such as auto paint shops.
- Do not use near medical equipment or if you have a pacemaker.
- Unplug from wall outlet before cleaning.
- To prevent overheating, do not block slots and openings in the cabinet or the back or bottom of equipment. Do not place equipment on beds, sofas, rugs, or other surfaces that generate fibers.
- To prevent overheating, do not place near or over a radiator or in a cabinet without proper ventilation.
- To reduce the risk of fire, use only 26 AWG or larger UL-listed or CSA-certified telecommunication line cord.
- Operate using the power source indicated on the marking label. If you are unsure about the type of power supply to your home or business, consult your power company.
- Do not place objects on the power cord. Do not step on the power cord.
- To prevent exposure to dangerous voltage, do not push objects through cabinet slots.
- To reduce the risk of electric shock, do not disassemble equipment or open parts other than specified access doors. Opening or removing parts may expose you to dangerous voltage or other risks. Incorrect reassembly can cause electric shock when equipment is subsequently used.
- Do not overload wall outlets and extension cords.
- Unplug equipment and contact qualified service if any of the following has occurred:
  - Power supply cord or plug has been damaged or frayed.
  - Liquid has been spilled on or in the equipment.

- Equipment has been exposed to rain or water.
- Equipment does not work normally even when the operating instructions are followed. Adjust only those controls referred to in the operating instructions. Improper adjustment of other controls may result in damage and may require extensive work by an authorized service center.
- Equipment has been dropped and damaged.
- Equipment has exhibited a distinct change in performance.
- Do not put the handset of the telephone next to your ear when the handset is not in normal talk mode.
- Radio signals transmitted between the handset and base may cause interference with hearing aids.
- The cord may contain lead, a chemical known to the State of California to cause birth defects or other reproductive harm. Wash hands after handling.
- Install the product at a minimum distance of 100 cm (39") to persons and animals.

### **Installation Guidelines**

Follow all warnings and instructions.

- Do not install equipment near a bath tub, sink, or shower.
- Operate the equipment using only the power source indicated on the marking label. If you are unsure of the power supply to your home or business, consult with your power company.
- To avoid interference to nearby appliances, do not place base of the phone on or near a television, VCR, or microwave oven.
- Do not expose the equipment to direct sunlight.
- Do not place equipment on an unstable cart, stand, or table.
- Adjust only those controls referred to in the operating instructions. Improper adjustment of other controls may result in damage and may require extensive work to restore equipment to normal operation.
- The location of the device should be close to a continuous power outlet (an AC outlet that does not have a switch to interrupt power).
- Keep the device away from sources of electrical noise such as motors or fluorescent lighting.

### **NOTICE**

To avoid damage to the equipment, observe the following precautions:

- Do not expose to water, rain, or moisture.
- Place securely on a stable surface.
- To avoid damage during an electrical storm, equipment should be plugged into a surge protector.

### **Cordless telephone privacy**

Cordless telephones are radio devices. Communications between the handset and base of your cordless telephone are accomplished by means of radio waves which are broadcast over the open

airways. Because of the inherent physical properties of radio waves, your communications can be received by radio receiving devices other than your own cordless telephone unit. Consequently, any communications using your cordless telephone may not be private.

### **Cleaning**

Do not clean with liquid or aerosol cleaners, household polish, chemicals, or cleaning agents. To avoid static shock, do not clean with a dry cloth. Clean with only a damp (not wet) cloth.

### **Disposal**

Disposal of electrical and electronic products should be done in line with local regulations. Please contact local authorities for further information.

## **FCC and Other Information**

This equipment complies with Parts 68 of the FCC rules and the requirements adopted by the Administrative Council for Terminal Attachments (ACTA).

This device complies with part 15 of the FCC rules. Operation is subject to the following two conditions: (1) This device may not cause harmful interference, and (2) This device must accept any interference received, including interference that may cause undesired operation. Privacy of communications may not be ensured when using this phone.

These limits are designed to provide reasonable protection against harmful interference in a residential installation. This equipment generates, uses and can radiate radio frequency energy and, if not installed and used in accordance with the instructions, may cause harmful interference to radio communications. However, there is no guarantee that interference will not occur in a particular installation. If this equipment does cause harmful interference to radio or television reception, which can be determined by turning the equipment off and on, the user is encouraged to try and correct the interference by one or more of the following measures:

- Reorient or relocate the receiving antenna.
- Increase the separation between the equipment and receiver.
- Connect the equipment into an outlet or on a circuit different from that to which the receiver is connected.
- Consult the dealer or an experienced radio/TV technician for help.

### **FCC RF exposure warning**

To insure the safety of users, the FCC has established criteria for the amount of radio frequency energy various products may produce depending on their intended usage. This product has been tested and found to comply with the FCC's exposure criteria. For body worn operation, the FCC RF exposure guidelines were also met when used with the accessories supplied or designed for this product. Use of other accessories may not ensure compliance with FCC RF exposure guidelines and should be avoided.

**Caution:** To maintain compliance with the FCC's RF exposure guidelines, the internal antennas used for this mobile transmitter must provide a separation distance of at least 20 cm from all persons. The device must not be co-located or operating in conjunction with any other antenna or transmitter.

**Caution:** Any changes or modifications not expressly approved by the party responsible for compliance could void the user's authority to operate this device.

## Health and safety information FCC

### Exposure to Radio Frequency (RF) Signals

This device is a radio transmitter and receiver. It is designed and manufactured not to exceed the emission limits for exposure to radio frequency (RF) energy set by the Federal Communications Commission of the U.S. Government. These limits are part of comprehensive guidelines and establish permitted levels of RF energy for the general population. The guidelines are based on the safety standards previously set by both U.S. and international standards bodies:

This product has been shown to be capable of compliance for localized specific absorption rate (SAR) for uncontrolled environment/general population exposure limits specified in ANSI/IEEE Std. C95.1-1992 and has been tested in accordance with the measurement procedures specified in FCC/OET Bulletin 65 Supplement C (2001) and IEEE Std. 1528-2003 (December 2003).

## Standards Conformance

This device is FCC certified and meets US health, safety, and environmental standards. The declaration of conformity can be requested from Snom:

Snom Technology AG  
Wittestr. 30G  
13509 Berlin  
Germany

### M700

FCC ID: T7HX8660

Unauthorized opening, changing, or modifying the device will cause the warranty to lapse and may also result in the loss of the FCC certification. In case of malfunction contact authorized service personnel, your seller, or Snom.

- **Safety:** IEC 60950-1:2005
- **Connector:** RJ45 (8P8C)
- **Power over Ethernet (PoE):** IEEE 802.3af, Class 2

### M300

FCC ID: T7HX9430

Unauthorized opening, changing, or modifying the device will cause the warranty to lapse and may also result in the loss of the FCC certification. In case of malfunction contact authorized service personnel, your seller, or Snom.

- **Safety:** IEC 60950-1:2005
- **Connector:** RJ45 (8P8C)
- **Power:** Ten Pao SMPS adapter, model no. S003GU050060, input 100-240 VAC, output 5V DC 600 mA, coaxial power connector

## Regulatory Information Canada

### IC Number:

- M700: 4979B-X8660
- M300: 4979B-X9430

### Interference information

This device complies with Industry Canada licence-exempt RSS standard(s). Operation is subject to the following two conditions: (1) this device may not cause interference, and (2) this device must accept any interference, including interference that may cause undesired operation of the device.

Le présent appareil est conforme aux CNR d'Industrie Canada applicables aux appareils radio exempts de licence. L'exploitation est autorisée aux deux conditions suivantes: (1) l'appareil ne doit pas produire de brouillage, et (2) l'utilisateur de l'appareil doit accepter tout brouillage radioélectrique subi, même si le brouillage est susceptible d'en compromettre le fonctionnement.

Privacy of communications may not be ensured when using this equipment.

La confidentialité des communications ne peut pas être garantie avec cet équipement.

### Exposure to Radio Frequency (RF) Signals

This product is a radio transmitter and receiver. It is designed and manufactured not to exceed this emission limit for exposure to radio frequency (RF) energy set by the Ministry of Health (Canada), Safety Code 6. These limits are part of comprehensive guidelines and established permitted levels of RF energy for the general population. These guidelines are based on the safety standards previously set by international standard bodies. These standards include a substantial safety margin designed to assure the safety of all persons, regardless of age and health.

This device and its antenna must not be co-located or operating in conjunction with any other antenna or transmitter.

This device has been shown to be capable of compliance for localized specific absorption rate (SAR) for uncontrolled environmental / general public exposure limits specific in ANSI/IEEE C95.1-1992 and had been tested in accordance with the measurement procedures specified in IEEE 1528-2003.

This Class B digital apparatus complies with Canadian ICES-003. / CET appareil numérique de la classe B est conforme à la norme NMB-003 du Canada.

This product meets the applicable Industry Canada technical specifications. / Le présent matériel est conforme aux spécifications techniques applicables d'Industrie Canada.

# Introduction

In a typical telephony system, the M-series base station is connected to the local area network (LAN) which, in turn, is connected to a PBX or an IP Service Provider. The base station converts IP protocol to DECT protocol and transmits phone calls to and from the DECT handsets.

To be able to use the M-series DECT phones, the base station must be connected to your LAN and the handset(s) must be registered at the base station. This admin guide covers the manual configuration of one base station.

For information on multicell setup (M700 only), see "Multicell Deployment Guide Snom 700"; for information on provisioning settings, see "Provisioning Guide M700 and M300 Base Stations". Both can be found at [http://wiki.snom.com/Snom\\_M700/Documentation](http://wiki.snom.com/Snom_M700/Documentation).

M-series base stations follow most Snom configuration and management schemes. It is recommended to have a local HTTP/HTTPS server for firmware updates, central configuration management, and hosting firmware files for base stations, handsets, and repeaters. Handsets and repeaters are updated over the air by the base station.

Normally the initialization of the base station is completely automatic, using DHCP. If the base station cannot discover a DHCP server in the subnet, you can set it up manually via its web interface. As a minimum you will need to enter the IP address, netmask, IP gateway, and DNS server. Your VoIP service provider or your network may require more data; please ask your provider or your network's administrator for the requisite input.

# Setting Up

## M700

### Power Sourcing

The M700 is provided with both power and the network connection via PoE (Power over Ethernet). The PoE cable is connected to the RJ 45 connector on the back of the unit (see Fig. 1, below). There is no separate jack for a power adaptor.

**Note:** If your network does not have a PoE infrastructure, you can use a PoE injector as a mid-span device to provide power.

### Hardware Setup

The M700 is delivered with the footstand attached and ready to be placed on a desktop, shelf, cabinet, or on the floor. Without the footstand, it can be hung on the wall or mounted under the ceiling.

**Note:** For ceiling mounting, the separately available ceiling plate, PN 00003933, is needed. It can also be used to bolt the M700 to the wall more securely than by merely hanging it on hooks or screws.

#### Standing Unit

1. Connect the Ethernet cable to the RJ45 jack on the back of the device (see Fig. 1).
2. Place the cable securely in the cable guide.

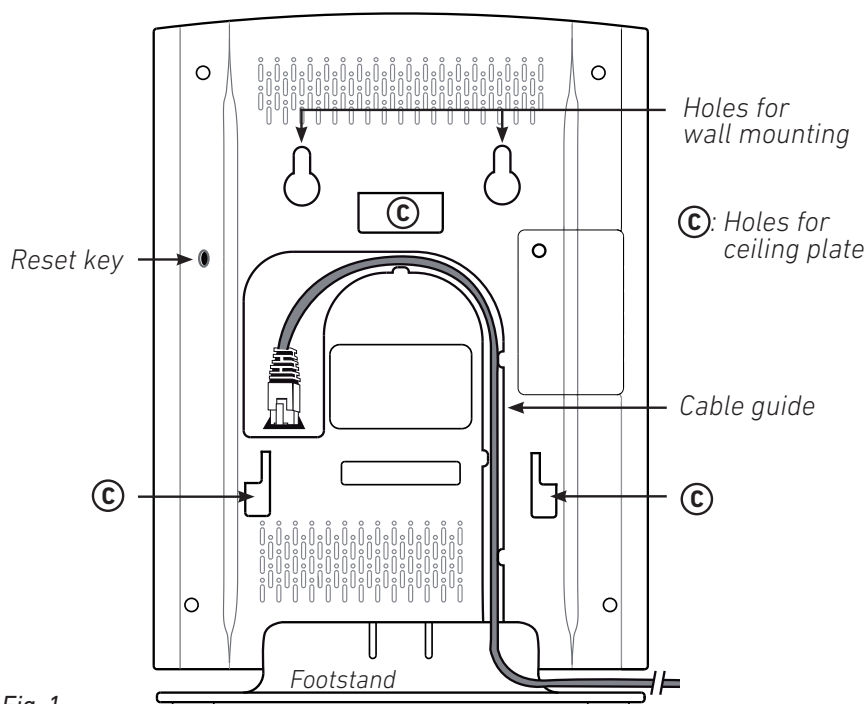

Fig. 1



## Wall or Ceiling Mounting

The M700 can be mounted under the ceiling or on the wall.

Prior to mounting the device under the ceiling or on the wall, you must remove the footstand of the unit and connect the Ethernet cable to the RJ 45 jack on the back of the unit.

1. Press the tab (Fig. 2, arrow 1) on the footstand inward while simultaneously pulling the footstand away from the body of the device (arrow 2).

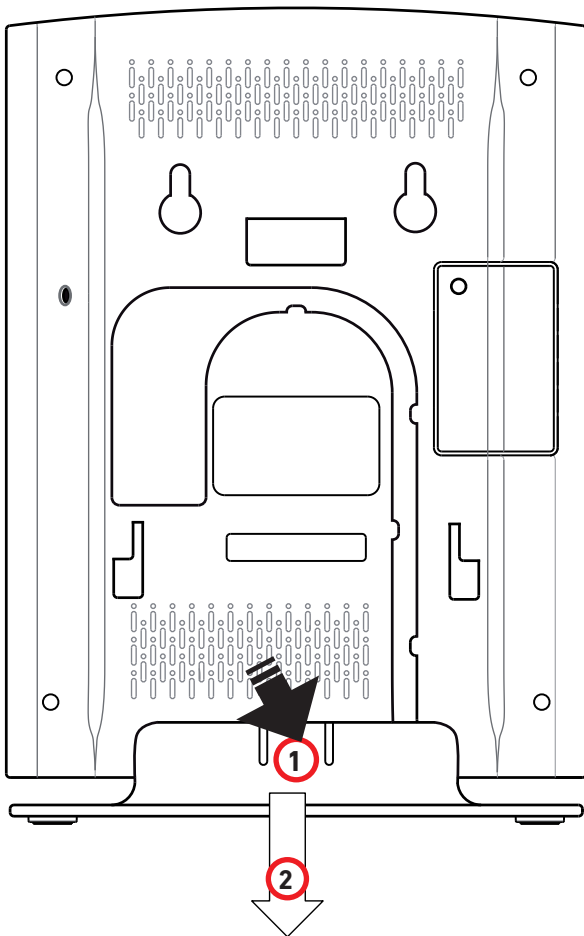

Fig. 2

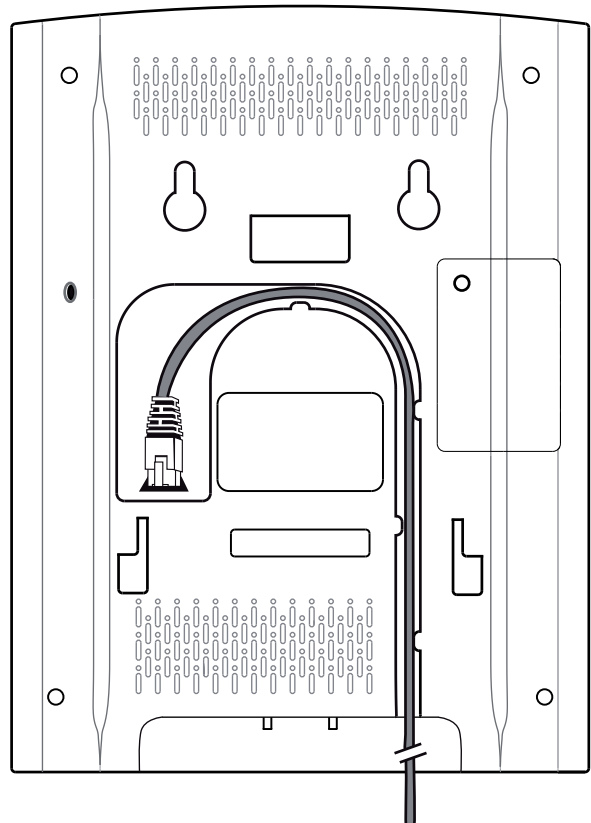

Fig. 3

2. Connect the Ethernet cable to the RJ45 jack on the back of the device (Fig. 3, above).
3. Place the cable securely in the cable guide (Fig. 3).

## Wall mounting

The M700 has two holes on the back (see Fig. 1 on page 16) that can be used to hang the unit on two screws or hooks on a wall.

**Note:** Screws/hooks and wall anchors are not included in the delivery. Use screws and wall anchors suitable for your wall.

The separately available ceiling plate, PN 00003933, can also be used to bolt the M700 to the wall more securely than by merely hanging it on hooks or screws.

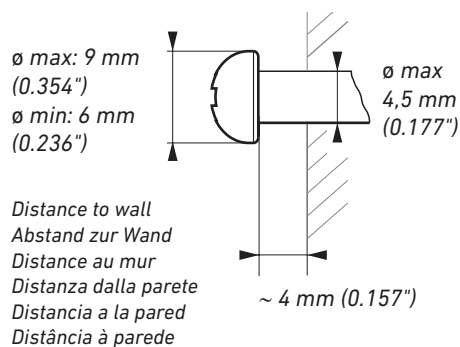

Fig. 4

1. Mark the centers of the two holes on the wall. The centers have to be 60 mm (2.3622") apart horizontally.
2. Drill the holes and insert the wall anchors flush to the wall.
3. Screw in the screws as shown in Fig. 4, above.
4. Place the two holes on the back of the device (see Fig. 1 on page 16) over the screws on the wall so that the LED of the device is facing upwards and the connectors are facing downwards.
5. Gently pull the base station down on the screws until they lock into place.

## Ceiling mounting

**NOTE:** For ceiling mounting, the separately available ceiling plate (PN 00003933) is necessary.

**Do not attempt to mount the base under the ceiling without the ceiling plate. The base station will fall off!**

1. Bolt the ceiling plate to the ceiling with the four screw anchors and screws provided.
2. Pull off the footstand of the M700 (see Fig. 2 on page 17).
3. Plug the Ethernet cable into the jack on the back of the M700 and place it firmly into the cable guide.
4. Place the M700 underneath the ceiling plate so that the three holes marked **C** (see Fig. 1 on page 16) are directly beneath the three hooks on the ceiling plate.
5. Push the M700 upward so that the hooks go into the holes.
6. Slide the M700 towards the angled "foot" of the ceiling plate (marked **F** in Fig. 5, below) until the two nibs on the bottom of the M700 (see Fig. 3 on page 17) protrude slightly from the two middle holes of the "foot" and the M700 audibly clicks into place on the plate.

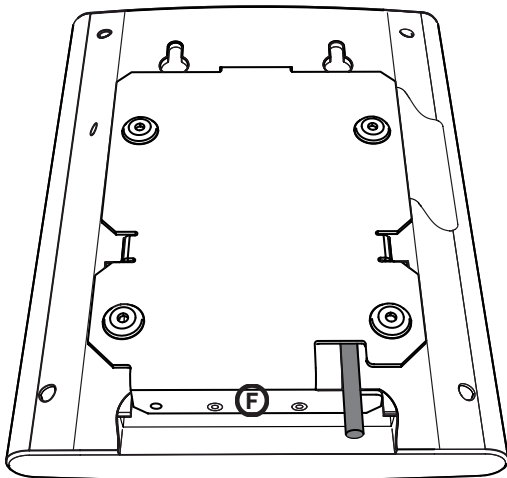

Fig. 5

## User Interface of the Unit

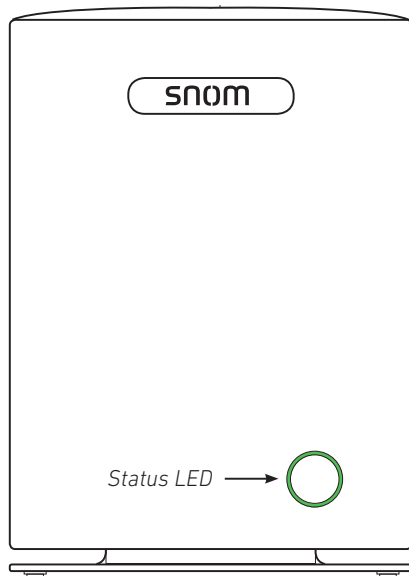

Fig. 6

### LED Status Indicator

At the front of the unit there is a multicolored LED for status signaling (Fig. 6). After the PoE cable - or the PoE injector cable, if PoE is not available - is connected to the unit, the orange LEDs will begin to blink, indicating that the unit is booting. When the solid green LEDs come on, the unit is connected to the network and is operational.

LED indicator	System state
Solid green	Operational
Blinking orange	Booting
Blinking red	Network or registration failure
Off	No power
Green, flashing rapidly	Software update in progress

### Reset Key

The reset key on the back of the unit (see Fig. 1 on page 16) is used to return the settings to factory defaults. To perform a factory reset, press the key with an object like the end of a paper clip for at least 10 seconds.

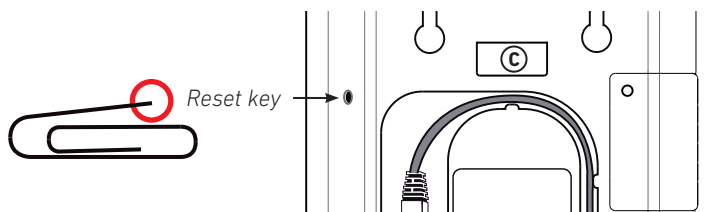

Fig. 7

## M300

Power is provided by the power adaptor included in the delivery.

### Hardware Setup

The M300 can be placed on a desktop, a shelf, or any other flat, even surface or mounted on a wall.

#### Standing Unit

1. Connect the Ethernet cable to the RJ45 jack on the back of the device.
2. Connect the coaxial connector of the power adaptor to the 5V DC jack on the back of the device.

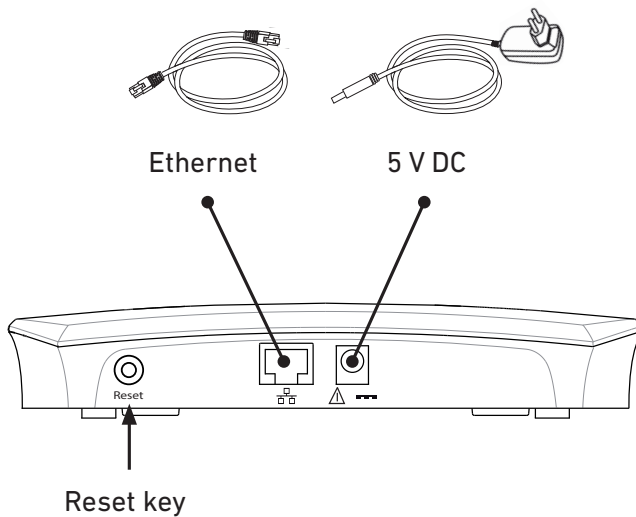

Fig. 1

#### Wall Mounting

The M300 can be mounted on the wall by simply hanging it on two suitable hooks or screws.

**NOTE:** Screws and wall anchors are not included in the delivery. Use screws and wall anchors suitable for your wall.

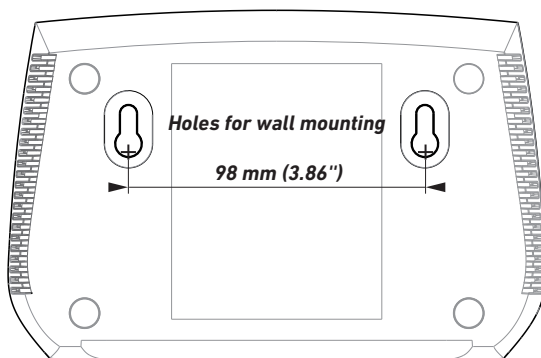

Fig. 2

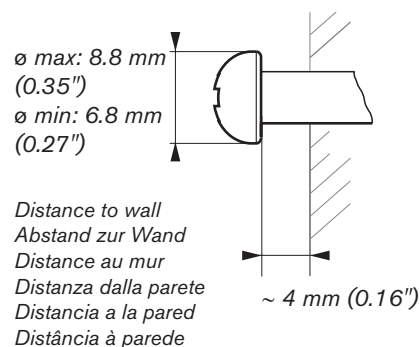

Fig. 3

1. Mark the centers of the two holes on the wall. The centers have to be 98 mm (3.86") apart horizontally (Fig. 2, above).

**Note:** When the device is mounted on the wall, the connectors for the Ethernet cable and the power adapter are on what in this position is the bottom of the device (Fig. 4). It is therefore advisable to mount the device above the Ethernet jack and the power outlet in the wall.

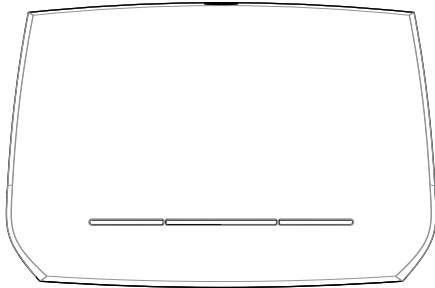

Fig. 4

2. Drill the holes and insert the wall anchors flush to the wall.
3. Screw in the screws as shown in Fig. 3.
4. Place the two top holes on the back of the device (Fig. 2) over the screws on the wall.
5. Gently pull the base down on the screws until they lock into place.
6. Connect the Ethernet cable to the RJ45 jack on what in this position is the bottom of the device (Fig. 1).
7. Connect the coaxial connector of the power adapter to the 5V DC jack on what in this position is the bottom of the device (Fig. 1).

## User Interface of the Unit

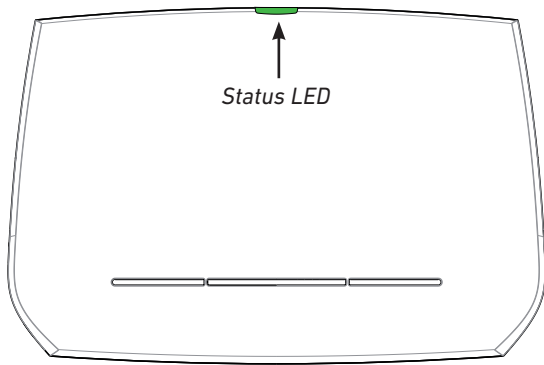

Fig. 1

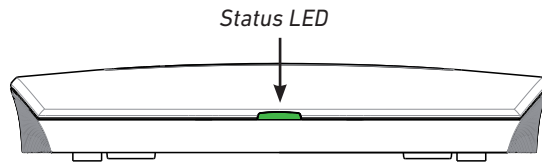

Fig. 2

## LED Status Indicator

At the front or top of the unit, depending on whether the unit is standing on a flat surface or mounted on the wall, there is a multicolored LED for status signaling (Fig. 1 and 2). After the device is connected to the network and to the power source, the orange LEDs will begin to blink, indicating that the unit is booting. When the solid green LEDs come on, the unit is connected to the network and is operational.

LED indicator	System state
Solid green	Operational
Blinking orange	Booting
Blinking red	Network or registration failure
Off	No power
Green, flashing rapidly	Software update in progress

## Reset Key

The reset key on the back of the unit is used to return the settings to factory defaults. To perform a factory reset, press the key with a fingernail or an object like the end of a paper clip for at least 10 seconds.

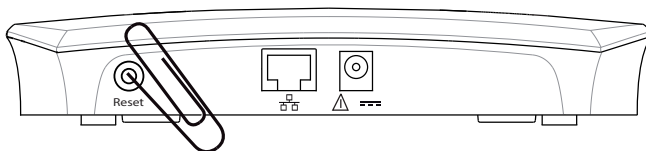

Fig. 1

# Configuring

To be able to use the M-series DECT phones, the base station must be connected to your network's or your VoIP service provider's PBX, and the handset(s) must be registered at the base station. This admin guide covers the manual configuration of the base station.

For information on provisioning settings, see "Provisioning Guide M700 and M300 Base Stations"; for information on multicell setup (M700 only), see the "M700 Multicell Deployment Guide", both on [http://wiki.snom.com/Snom\\_M700/Documentation](http://wiki.snom.com/Snom_M700/Documentation).

M-series base stations follow most Snom configuration and management schemes. It is recommended to have a local HTTP/HTTPS server for firmware updates, central configuration management, and hosting firmware files for base stations, handsets, and repeaters. Handsets and repeaters are updated over the air by the base station.

## Preliminary Steps

Normally the initialization of the base station is completely automatic, using DHCP. If the base station cannot discover a DHCP server in the subnet, you can set it up manually via its web interface. As a minimum you will need to enter the IP address, netmask, IP gateway, and DNS server. Your VoIP service provider or your network may require more data; please ask your provider or your network's administrator for the requisite input.

### Finding the IP Address of the Base Station

You can use any M65, M85, or M25 handset in the vicinity of the base station to find the base's IP address. The handset does not need to be registered at the base.

1. Connect the base station to your network and wait until the LED is green.
2. Press the menu key  on the M65/M85 handset or the center of the navigation key on the M25. The main menu screen (Fig. 1) will appear on the display.

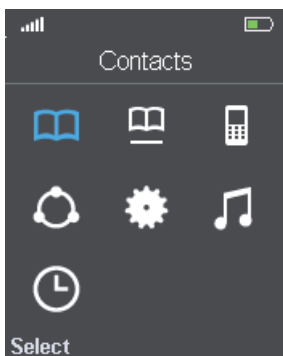

Fig. 1

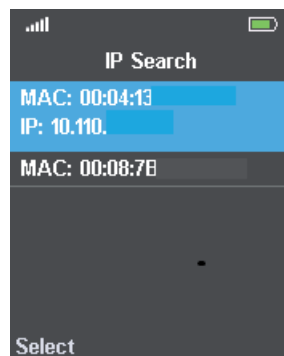

Fig. 2

3. Type \*47\*. The IP Search screen opens (Fig. 2). If your handset detects more than one base station within range, check the MAC address on the back of your base station and use the navigation key to select your base.



## Opening the Web User Interface

1. Open a web browser on your PC. Enter the IP address, preceded by "http://" in the address bar (for example: http://192.168.10.115) and press ENTER.
2. Enter your user name and password in the pop-up window. The defaults for both are admin:

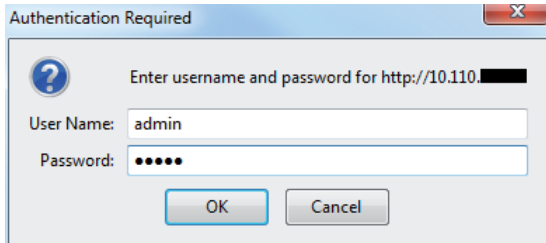

Default user name: admin  
 Default password: admin

Fig. 3

3. Click on **OK**.

The **Home/Status** page opens, showing your system information. The vertical menu on the left side of the window is always the same, no matter which window happens to be open at the time. Click on a menu item to open that page.

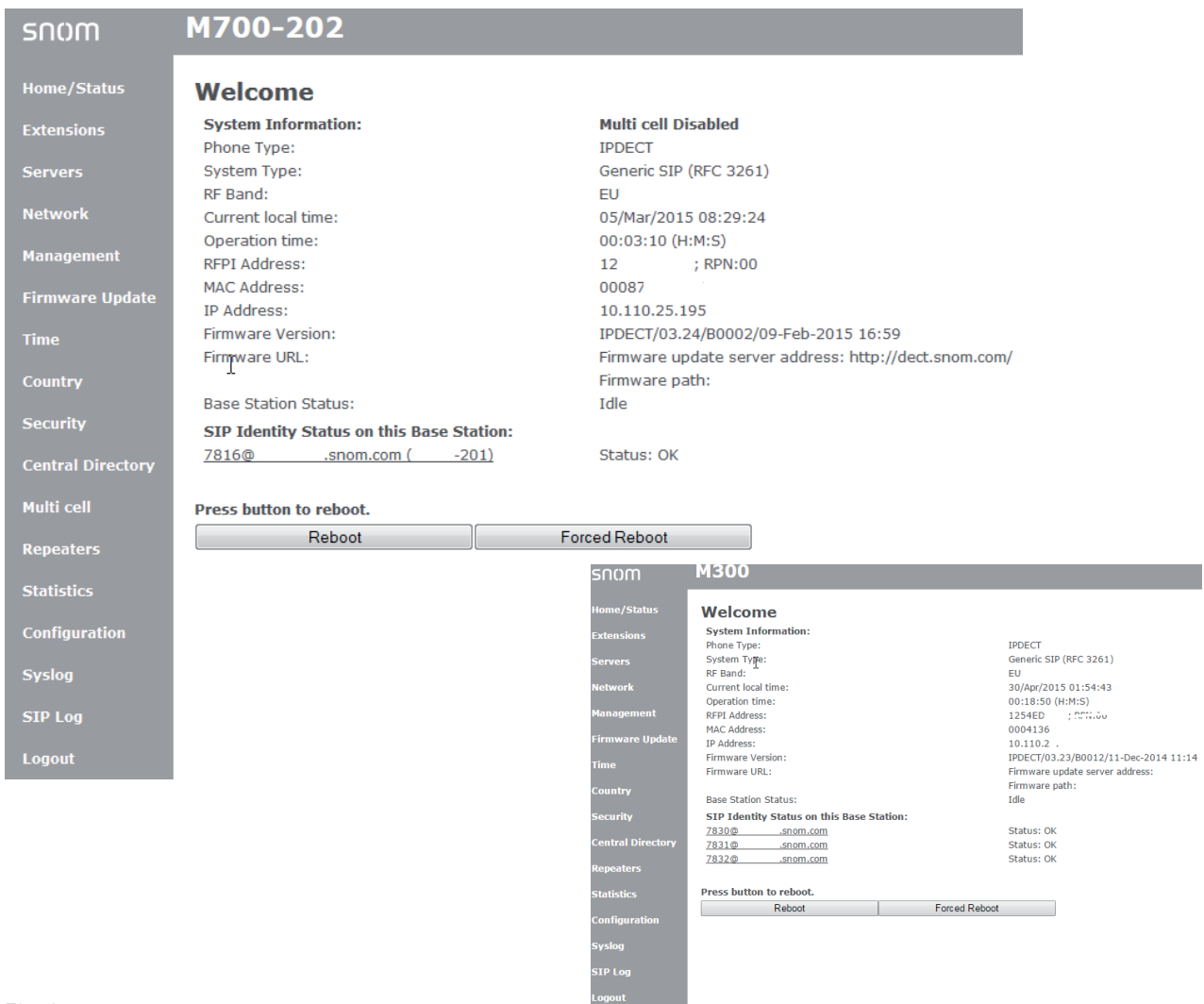

Fig. 4

# Initial Settings

## Servers

During the initialization, the default server settings are loaded automatically. For a description of the settings, see "Servers" on page 61.

## Language, Country, and Time/Date

The **Country** page contains drop-down menus for the selection of your country, a state or region within that country, if applicable, and the language to be used on the web interface of the base station.

There are also two checkboxes for the settings **Set timezone by country/region** and **Set DST by country/region**. By default, the checkboxes are ticked. This means that the time zone and the daylight saving time (DST) are set automatically to the country and, if applicable, the state/region of that country you selected.

### Selecting country, region, and language

1. Select your **country** from the drop-down menu.

For some countries like the US and Australia, state or region options affecting time zone and DST settings can also be selected. Select your **state/region** from the drop-down menu.

2. Select the **language** for the web interface of the base station from the drop-down menu. The default is English.
3. If you do not want to select the time zone of the country/region selected in step 1, tick the checkbox of **Set timezone by country/region** to disable the automatic setting.

If you want to disable DST, tick the checkbox of **Set DST by country/region** to uncheck it.

**Note:** Ticking the checkboxes will result in checking and unchecking them on both the **Country** page and the **Time** page.

When the automatic settings are disabled, time and DST can be set manually on the **Time** page.

4. Click on **Save**.

**Country**

Select country: US / Canada

State / Region: Alabama

Select Language: English

Set timezone by country/region:

Set DST by country/region:

Notes: Time zone is CST, not fitting the unofficial use of EST in Phenix City.

Save and Reboot Save Cancel

Fig. 1

## Extensions - M700

To be able to use a handset, an extension must have been set up for it on the web interface of the base station, and the handset must be registered for the extension using one of two methods. On Snom corded desk phones, these extensions (or accounts) are called "identities".

**Note:** An extension/identity can only be assigned to one handset in your single-cell or multicell installation. Do not try to register more than one handset for an extension.

### Setting up Extensions - M700

1. Click on **Extensions** to open the **Extensions** page.

#### Extensions

[Add extension](#)  
[Stop Registration](#)

Idx	IPEI	Handset State	Handset Type FW Info	FWU Progress	VoIP Idx	Extension	Display Name	Server	Server Alias	State
There are currently no extensions for server										

Fig. 1

2. Click on Add extension.

Depending on your PBX, the information you need to enter will vary. Handset selection, Extension setting, and Server selection are mandatory. The remaining settings depend on the requirements of your PBX or VoIP provider and can be left blank, if nothing is required. Check with your IT administrator or service provider. Mandatory settings:

- a. **Handset.** The default setting is **New Handset**. You can select an existing handset Idx from the drop-down menu.
- b. Enter the extension number in the **Extension** text field.

**Note:** If the number of your extension is also the number of your mailbox, enter it in the text field of **Mailbox Number** and, if no mailbox name is set, in the text field of **Mailbox Name**, as well.

If a PIN is required to listen to your VoiceMail, type it in the text field of **PIN**.

**Note:** This PIN is not to be confused with either the access code for registering the handset at the base station or the PIN for resetting the handset to factory values or for deregistering it from the base station.

- c. Select the server from the drop-down menu of **Server**.
- d. Click on **Save**.

**Edit extension**

Line name:

Handset:

Extension:

Authentication User Name:

Authentication Password:

Display Name:

PIN:

Mailbox Name:

Mailbox Number:

Server:

Call waiting feature:

BroadWorks Shared Call Appearance:

Broadsoft Feature Event Package:

Forwarding Unconditional Number:

Forwarding No Answer Number:   s

Forwarding on Busy Number:

Fig. 2

**Registering Handsets on M700 - Method 1**

1. After setting up the extension as shown in the preceding paragraph, click on the string of capital Fs underneath the **IPEI** header in the table on the **Extensions** page.

**Extensions**

[Add extension](#)  
[Stop Registration](#)

	Idx	IPEI	Handset State	Handset Type FW Info	FWU Progress		VoIP Idx	Extension	Display Name	Server	Server Alias	State
<input type="checkbox"/>	1	FFFFFFFFF				<input type="checkbox"/>	1	7816		.snom.com	-201	
<a href="#">Check All / Uncheck All</a>						<a href="#">Check All Extensions / Uncheck All Extensions</a>						

With selected: [Delete Handset\(s\)](#) [Register Handset\(s\)](#) [Deregister Handset\(s\)](#) [Start SIP Registration\(s\)](#) [SIP Delete Extension\(s\)](#)

Fig. 3

2. Enter the IPEI of the handset.

**Handset**

Location:

IPEI:

AC:

Alarm Line:

Alarm Number:

Fig. 4

**Handset**

Location:

IPEI:

AC:

Alarm Line:

Alarm Number:

Fig. 5

**Note:** To find the IPEI, open the **Settings**  menu of the handset, select **Status**, and scroll down to the IPEI at the end of the handset status. The IPEI consists of a string of 10 decimals and capital letters. Do not enter the colons grouping the characters of the string into twos.

3. Click on **Save**. In the table on the **Extensions** page, the IPEI has been added under the IPEI header.

4. Check the box to the left of the Idx and click on **Register Handset(s)**.

**Extensions**

[Add extension](#)  
[Stop Registration](#)

	Idx	IPEI	Handset State	Handset Type FW Info	FWU Progress		VoIP Idx	Extension	Display Name	Server	Server Alias	State
<input checked="" type="checkbox"/>	1	02523	Detached			<input type="checkbox"/>	1	7816		.snom.com	-201	
<a href="#">Check All / Uncheck All</a>						<a href="#">Check All Extensions / Uncheck All Extensions</a>						
With selected: <a href="#">Delete Handset(s)</a> <a href="#">Register Handset(s)</a> <a href="#">Deregister Handset(s)</a> <a href="#">Start SIP Registration(s)</a> <a href="#">SIP Delete Extension(s)</a>												

Fig. 6

5. Check the box to the left of the VoIP Idx and click on **Start SIP Registration(s)**.

**Extensions**

[Add extension](#)  
[Stop Registration](#)

	Idx	IPEI	Handset State	Handset Type FW Info	FWU Progress		VoIP Idx	Extension	Display Name	Server	Server Alias	State
<input type="checkbox"/>	1	02523	Detached			<input checked="" type="checkbox"/>	1	7816		.snom.com	-201	
<a href="#">Check All / Uncheck All</a>						<a href="#">Check All Extensions / Uncheck All Extensions</a>						
With selected: <a href="#">Delete Handset(s)</a> <a href="#">Register Handset(s)</a> <a href="#">Deregister Handset(s)</a> <a href="#">Start SIP Registration(s)</a> <a href="#">SIP Delete Extension(s)</a>												

Fig. 7

The handset has been registered to use the extension. **Note:** To be able to use the handset, you also need to select **Register** in the **Connectivity** menu of the handset itself.

**Extensions**

[Add extension](#)  
[Stop Registration](#)

	Idx	IPEI	Handset State	Handset Type FW Info	FWU Progress		VoIP Idx	Extension	Display Name	Server	Server Alias	State
<input type="checkbox"/>	1	0253	Present@RPN00	M65 316.2	Off	<input type="checkbox"/>	1	7816		.snom.com	ser-fx-201	SIP Registered@RPN00
<a href="#">Check All / Uncheck All</a>						<a href="#">Check All Extensions / Uncheck All Extensions</a>						
With selected: <a href="#">Delete Handset(s)</a> <a href="#">Register Handset(s)</a> <a href="#">Deregister Handset(s)</a> <a href="#">Start SIP Registration(s)</a> <a href="#">SIP Delete Extension(s)</a>												

Fig. 8

6. Set up another extension (see "Setting up Extensions" on page 29, step 2) and repeat steps 1 - 5 for every handset.

**Registering Handsets on M700 - Method 2**

For this method, you need to have all handsets within reach. Set up all extensions as described in "Setting up Extensions - M700" on page 27, then perform the following steps for each handset.

1. In the table on the Extensions page, check the box to the left of the Idx and then click on **Register Handset(s)**.

**Extensions**

[Add extension](#)  
[Stop Registration](#)

	Idx	IPEI	Handset State	Handset Type FW Info	FWU Progress		VoIP Idx	Extension	Display Name	Server	Server Alias	State
<input type="checkbox"/>	1	FFFFFFFF				<input type="checkbox"/>	1	7816		.snom.com	-201	
<a href="#">Check All / Uncheck All</a>						<a href="#">Check All Extensions / Uncheck All Extensions</a>						
With selected: <a href="#">Delete Handset(s)</a> <a href="#">Register Handset(s)</a> <a href="#">Deregister Handset(s)</a> <a href="#">Start SIP Registration(s)</a> <a href="#">SIP Delete Extension(s)</a>												

Fig. 9

- On the handset, select the **Connectivity** menu (Fig. 21).

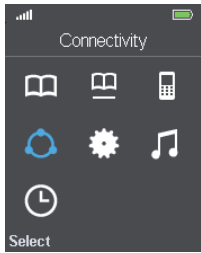

Fig. 10

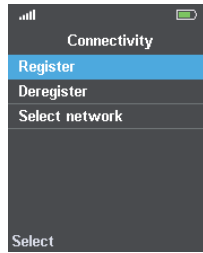

Fig. 11

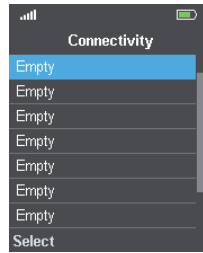

Fig. 12

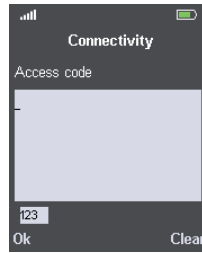

Fig. 13

- Select **Register** (Fig. 11).
- M65/M85: Select the first field with the word **Empty** in it (Fig. 12).

**Note:** Fields that do not say "Empty", i.e., that have no text or a different text, already contain a registration; if you select one of those, you will be asked whether you want to overwrite the current registration.

The M25 only supports one registration and won't show this screen.

- Enter the access code.
- In the table on the Extensions page, check the box to the left of the VoIP Idx and click on **Start SIP Registration(s)**.

**Extensions**

[Add extension](#)  
[Stop Registration](#)

	Idx	IPEI	Handset State	Handset Type FW Info	FWU Progress		VoIP Idx	Extension	Display Name	Server	Server Alias	State
<input type="checkbox"/>	1	FFFFFFFFF	Enabled			<input checked="" type="checkbox"/>	1	7816		.snom.com	-201	
<a href="#">Check All / Uncheck All</a>						<a href="#">Check All Extensions / Uncheck All Extensions</a>						
With selected:						<a href="#">Delete Handset(s)</a> <a href="#">Register Handset(s)</a> <a href="#">Deregister Handset(s)</a> <a href="#">Start SIP Registration(s)</a> <a href="#">SIP Delete Extension(s)</a>						

Fig. 14

After the message that the parameters have been saved, you will see that the handset's IPEI has been added to the table, indicating that the handset is registered to use the extension.

**Extensions**

[Add extension](#)  
[Stop Registration](#)

	Idx	IPEI	Handset State	Handset Type FW Info	FWU Progress		VoIP Idx	Extension	Display Name	Server	Server Alias	State
<input type="checkbox"/>	1	02523	Detached			<input type="checkbox"/>	1	7816		.snom.com	-201	
<a href="#">Check All / Uncheck All</a>						<a href="#">Check All Extensions / Uncheck All Extensions</a>						
With selected:						<a href="#">Delete Handset(s)</a> <a href="#">Register Handset(s)</a> <a href="#">Deregister Handset(s)</a> <a href="#">Start SIP Registration(s)</a> <a href="#">SIP Delete Extension(s)</a>						

Fig. 15

- Repeat steps 1 - 6 for all extensions.

### Selecting Emergency Alarm Setting on M700

If emergency alarm settings are available, you can select one of the configured profiles for each handset registered at the base station. Emergency alarm settings: See "Emergency alarm" on page 41.

**Note:** The majority of the features of the emergency alarm are available on the M85 only. Pressing the OK-/Confirm key on the idle M65 for three seconds (factory setting) will dial a call to the alarm number specified on the base station's web interface, if set. The M25 does not have an emergency alarm.

#### Handset (M65)

Location:

IPEI:

AC:

Alarm Line:

Alarm Number:

#### Alarm Profiles:

Profile	Alarm Type	
Profile 0	Alarm Button	<input checked="" type="checkbox"/>
Profile 1	Not configured	<input type="checkbox"/>
Profile 2	Alarm Button	<input type="checkbox"/>
Profile 3	Not configured	<input type="checkbox"/>
Profile 4	Not configured	<input type="checkbox"/>
Profile 5	Not configured	<input type="checkbox"/>
Profile 6	Not configured	<input type="checkbox"/>
Profile 7	Not configured	<input type="checkbox"/>

Fig. 16

1. Open the **Extensions** page and click on the **IPEI** of the handset (Fig. 15).
2. Select the handset's extension from the drop-down menu of **Alarm line** (Fig. 16).
3. Enter the phone number to be called in case of an emergency alarm in the text field of **Alarm number**.
4. Select one of the configured profiles by clicking on its checkbox.
5. Click on **Save**.

### Deregistering/Deleting Handsets and/or SIP Registrations on M700

#### Extensions

[Add extension](#)  
[Stop Registration](#)

	Idx	IPEI	Handset State	Handset Type FW Info	FWU Progress		VoIP Idx	Extension	Display Name	Server	Server Alias	State
<input checked="" type="checkbox"/>	1	0253C	Present@RPN00	M65 316.2	Off	<input checked="" type="checkbox"/>	1	7816		.snom.com	ser-fx-201	SIP Registered@RPN00

[Check All / Uncheck All](#)
[Check All Extensions / Uncheck All Extensions](#)

With selected: [Delete Handset\(s\)](#) [Register Handset\(s\)](#) [Deregister Handset\(s\)](#) [Start SIP Registration\(s\)](#) [SIP Delete Extension\(s\)](#)

Fig. 17

- To deregister a handset, click on the checkbox to the left of the **Idx** and on the link **Deregister Handset(s)**.
- To delete a handset, click on the checkbox to the left of the **Idx** and on the link **Delete Handset(s)**.
- To delete a SIP registration, click on the checkbox to the left of the **VoIP Idx** and on the link **SIP Delete Extension(s)**.

## Extensions - M300

To be able to use a handset, an extension must have been set up for it on the web interface of the base station, and the handset must be registered for the extension.

Click on **Extensions** to open the **Extensions and Handsets** page. By default, **Extensions** is visible (Fig. 1), as indicated by its larger font. Click on the **Handset** link in Fig. 1 if you want to switch to the **Handsets** view (Fig. 2).

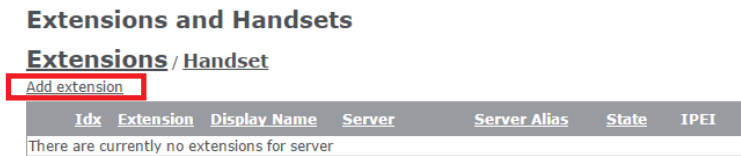

Fig. 1

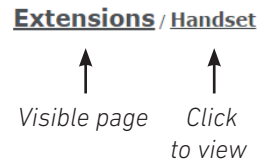
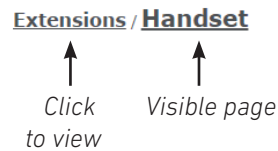

Fig. 2



### Setting up extension and handset on M300

1. On the **Extensions** page, click on **Add extension** (Fig. 1). The **Add extension** page opens (Fig. 3). Depending on your PBX, the information you need to enter will vary. **Extension** setting and **Server** selection are mandatory. The remaining settings depend on the requirements of your PBX or VoIP provider and can be left blank, if nothing is required. Check with your IT administrator or service provider. As a minimum you will need to:
  - a. Enter the extension number in the **Extension** text field.
  - b. If there is more than one SIP server in your network, select the one you wish to use from the drop-down menu of **Server**, if necessary.
  - c. Click on the checkbox to the left of the **Add Handset** line.

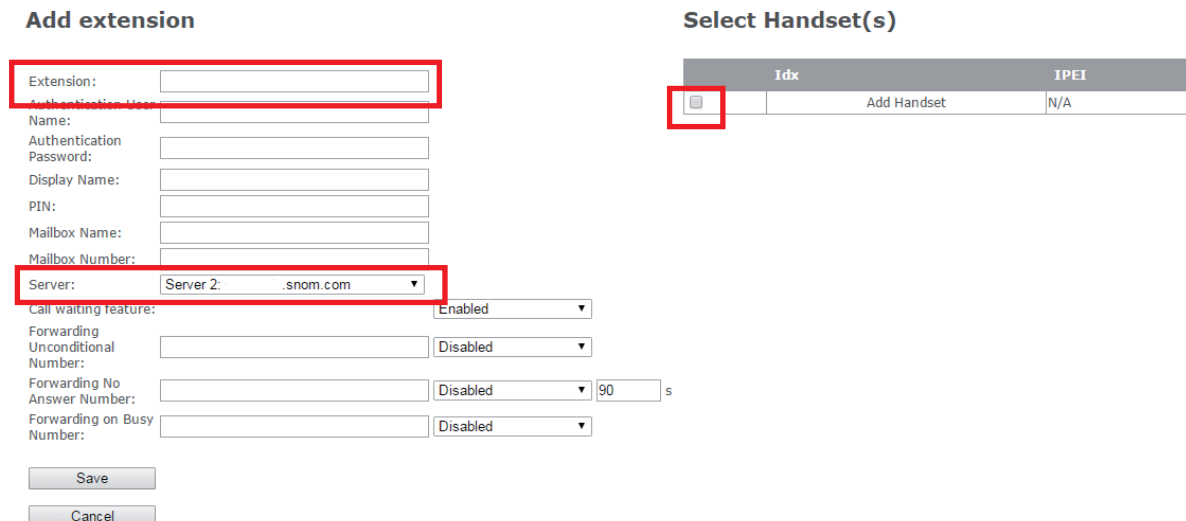

Fig. 3



**Add extension**

Extension:

Authentication User Name:

Authentication Password:

Display Name:

PIN:

Mailbox Name:

Mailbox Number:

Server:

Call waiting feature:

Forwarding Unconditional Number:

Forwarding No Answer Number:   s

Forwarding on Busy Number:

**Select Handset(s)**

Idx	IPEI
<input checked="" type="checkbox"/>	Add Handset N/A

Fig. 4

d. Click on **Save**.

2. On the **Extensions** page, click on the string of capital Fs underneath the **IPEI** header.

**Extensions and Handsets**

**Extensions / Handset**

[Add extension](#)

Idx	Extension	Display Name	Server	Server Alias	State	IPEI
<input type="checkbox"/>	1	7830		.snom.com		EEEEEEEEEE

[Check All Extensions /](#)  
[Uncheck All Extensions](#)

With selected: [Start SIP Registration\(s\)](#) [SIP Delete Extension\(s\)](#)

Fig. 5

3. Enter the IPEI of the handset (Fig. 7).

**Handset**

IPEI:

AC:

Emergency Line:

Emergency Number:

**Handset**

IPEI:

AC:

Emergency Line:

Emergency Number:

Fig. 6

Fig. 7

**Note:** To find the IPEI, open the **Settings**  menu of the handset, select **Status**, and scroll down to the IPEI at the end of the handset status. The IPEI consists of a string of 10 decimals and capital letters. Do not enter the colons grouping the characters of the string into twos.

4. Click on **Save**.

5. In the table on the **Extensions** page, the IPEI has been added under the IPEI header (Fig. 8). Check the box to the left of the Idx and click on **Start SIP Registration**.

**Extensions and Handsets**

**Extensions / Handset**

Add extension

Idx	Extension	Display Name	Server	Server Alias	State	IPEI
<input type="checkbox"/>	1	7830	.snom.com			0253

Check All Extensions /  
Uncheck All Extensions

With selected: Start SIP Registration(s) SIP Delete Extension(s)

Fig. 8

Upon successful registration, the **State** of the **Extension** page should now be listed as **SIP registered** (Fig. 9).

**Extensions and Handsets**

**Extensions / Handset**

Add extension

Idx	Extension	Display Name	Server	Server Alias	State	IPEI
<input type="checkbox"/>	1	7830	.snom.com		SIP Registered	0253

Check All Extensions /  
Uncheck All Extensions

With selected: Start SIP Registration(s) SIP Delete Extension(s)

Fig. 9

**Note:** You also have to register the handset from the handset itself (Settings menu > Connectivity > Register). Please consult the handset manual for further information.

**Selecting Multiple Handsets for an Extension**

1. Open the **Extensions and Handsets** page and click on the extension.

**Extensions / Handset**

Add extension

Idx	Extension	Display Name	Server	Server Alias	State	IPEI
<input type="checkbox"/>	1	7994	.snom.com		SIP Registered	02523
<input type="checkbox"/>	2	7995	.snom.com		SIP Registered	0276A

Check All Extensions /  
Uncheck All Extensions

Fig. 10

The **Edit extension** page of the selected extension opens. The checkboxes in the **Select Handset(s)** table indicate which handset is currently using the extension.

**Edit extension**

Extension:

Authentication User Name:

Authentication Password:

**Select Handset(s)**

Idx	IPEI
<input type="checkbox"/>	Add Handset
<input checked="" type="checkbox"/>	1 02523
<input type="checkbox"/>	2 0276A

Fig. 11

2. Click the checkbox(es) of the additional handset(s) you want to be able to use the extension, i.e., accept incoming calls for the extension, etc.

**Edit extension**

Extension:

Authentication User Name:

Authentication Password:

**Select Handset(s)**

Idx	IPEI
<input type="checkbox"/>	Add Handset
<input checked="" type="checkbox"/>	1 02523
<input checked="" type="checkbox"/>	2 0276A

Fig. 12

3. Click **Save**. The additional handset(s) are added to the extension's IPEI field on the **Extensions and Handsets** page.

**Extensions / Handset**

Add extension

	Idx	Extension	Display Name	Server	Server Alias	State	IPEI
<input type="checkbox"/>	1	7994		████████.snom.com		SIP Registered	0252C ██████████
<input type="checkbox"/>	2	7995		████████.snom.com		SIP Registered	0276A ██████████

Check All Extensions /  
Uncheck All Extensions

Fig. 13

**Selecting Emergency Alarm Setting on M300**

If emergency alarm settings are available, you can select one of the configured profiles for each handset registered at the base station. Emergency alarm settings: See "Emergency alarm" on page 41.

**Note:** All features of the emergency alarm settings are available on the M85 only. The M65 can be enabled to send an alarm call to the specified alarm number using the factory settings. The M25 does not have an emergency alarm.

1. Open the **Extensions and Handsets** page, click on **Handset** (see Fig. 2 on page 32) and then on the **IPEI** of the handset.
2. Select the handset's extension from the drop-down menu of **Alarm line**.

**Handset (M65)**

Location: ANY

IPEI: 0253C

AC: 0000

Alarm Line: 7816

Alarm Number: 7831

**Alarm Profiles:**

Profile	Alarm Type	
Profile 0	Alarm Button	<input checked="" type="checkbox"/>
Profile 1	Not configured	<input type="checkbox"/>
Profile 2	Alarm Button	<input type="checkbox"/>
Profile 3	Not configured	<input type="checkbox"/>
Profile 4	Not configured	<input type="checkbox"/>
Profile 5	Not configured	<input type="checkbox"/>
Profile 6	Not configured	<input type="checkbox"/>
Profile 7	Not configured	<input type="checkbox"/>

Fig. 10

3. Enter the phone number to be called in case of an emergency alarm in the text field of **Alarm number**.
4. Select one of the configured profiles by clicking on its checkbox (Fig. 10).
5. Click on **Save**.

### **Deleting Handset on M300**

1. Open the **Handset** page.
2. Click on the checkbox to the left of the **Idx** and on the link **Delete Handset(s)**.

### **Deregistering SIP Registrations on M300**

1. Open the **Extensions** page.
2. Click on the checkbox to the left of the **Idx** and on the link **SIP Delete Extension(s)**.

## Registering M5 repeaters

The maximum number of repeaters per base station is 3 (three). In a single-cell system, the base station (the **DECT sync source**) will always be RPN00; the repeaters will be numbered RPN01, RPN02, and RPN03. In a multicell system, you can look up the RPNs of base stations and repeaters on the **Multicell** page of the web user interface.

There are two **DECT sync modes**, **Manual** and **Local Automatical**. Automatic sync mode is recommended for repeaters registered directly at the base station or - in a multicell system - directly at the primary or any secondary base station in the chain. When repeaters are daisy-chained to other repeaters, manual sync mode must be used.

**Note:** If you have changed the access code (AC) for registering handsets at the base station to a custom code, you must change it back to the default 0000 to be able to register repeaters.

### Automatic registration

When this method is used, the repeater will look for the best base station signal, and the base station will automatically assign an RPN. This method is recommended for registering repeaters directly at the base station.

1. Open the **Repeaters** page.

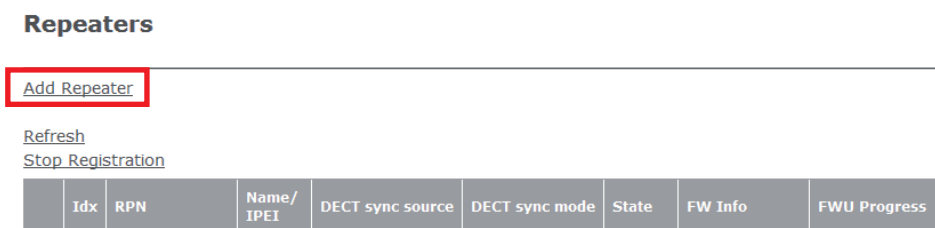

Fig. 1

2. Click on **Add Repeater** (Fig. 1).
3. Enter a name for the repeater, for example a consecutive number or its location. This name will be listed in the **Name/IPEI** column on the **Repeater** page (Fig. 3); if you do not enter a name, the IPEI will be listed instead.

The screenshot shows the 'Repeater' configuration form. The 'Name' field contains the text 'M5\_01'. The 'DECT sync mode' dropdown menu is set to 'Local Automatical'. A 'Save' button is located below the fields.

Fig. 2

4. Select **Local Automatical** from the DECT sync mode drop-down menu.
5. Click on **Save**.

### Repeaters

[Add Repeater](#)

[Refresh](#)  
[Stop Registration](#)

	Idx	RPN	Name/ IPEI	DECT sync source	DECT sync mode	State	FW Info	FWU Progress
<input type="checkbox"/>	1		M5_01/ FFFFFFFF	RPNF0 (-∞dBm)	Local Automatical			

[Check All / Uncheck All](#)  
 With selected: [Delete Repeater\(s\)](#), [Register Repeater\(s\)](#) [Deregister Repeater\(s\)](#)

Fig. 3

6. Connect the repeater to a power outlet.
7. Press the reset tab on the back of the repeater for approx. 2 seconds until the LED blinks red briefly and then switches to double green flashes.

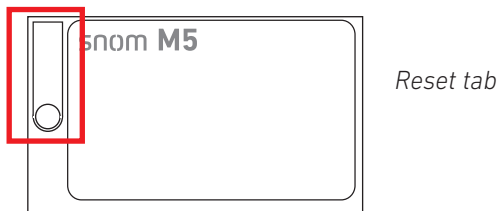

Fig. 4

8. On the **Repeater** page, check the box to the left of the Idx and then click on **Register Repeater(s)**.

### Repeaters

[Add Repeater](#)

[Refresh](#)  
[Stop Registration](#)

	Idx	RPN	Name/ IPEI	DECT sync source	DECT sync mode	State	FW Info	FWU Progress
<input checked="" type="checkbox"/>	1		M5_01/ FFFFFFFF	RPNF0 (-∞dBm)	Local Automatical	Enabled		

[Check All / Uncheck All](#)  
 With selected: [Delete Repeater\(s\)](#), [Register Repeater\(s\)](#) [Deregister Repeater\(s\)](#)

Fig. 5

Upon successful registration, the **Repeater** page will show the repeater's and the base station's RPNs, the repeater's IPEI, and the state as "Enabled".

### Repeaters

[Add Repeater](#)

[Refresh](#)  
[Stop Registration](#)

	Idx	RPN	Name/ IPEI	DECT sync source	DECT sync mode	State	FW Info	FWU Progress
<input type="checkbox"/>	1	RPN01	M5_01/ 016E8	RPN00 (-34dBm)	Local Automatical	Enabled	33	Off

[Check All / Uncheck All](#)  
 With selected: [Delete Repeater\(s\)](#), [Register Repeater\(s\)](#) [Deregister Repeater\(s\)](#)

Fig. 6

### Manual registration

This method must be used for daisy-chaining two or three repeaters. The RPN for the repeater as well as its DECT sync source must be selected manually from the respective drop-down menus.

1. Open the **Repeaters** page (Fig. 6, above).
2. Click on **Add Repeater**.
3. Enter a name for the repeater, for example a consecutive number or its location. If you do not enter a name, the IPEI will be listed.

**Repeater**

Name:

DECT sync mode:

RPN	DECT sync source
<input type="text" value="RPN02"/>	<input type="text" value="RPN01"/>

Fig. 7

4. Select **Manually** from the DECT sync mode drop-down menu (Fig. 7).
5. Select the **DECT sync source** from the drop-down menu. In the example (Fig. 8, below), the DECT sync source of the second repeater is the first repeater from Fig. 6, above, therefore RPN01 is selected.

**Repeater**

Name:

DECT sync mode:

RPN	DECT sync source
<input type="text" value="RPN01"/>	<input type="text" value="RPN01"/>

Fig. 8

6. Select the RPN from the drop-down menu of **RPN**.

**Repeater**

Name:

DECT sync mode:

RPN	DECT sync source
<input type="text" value="RPN01"/>	<input type="text" value="RPN01"/>

Fig. 9

7. Click on **Save**.
8. Connect the repeater to a power outlet.

9. Press the reset tab on the back of the repeater (see Fig. 4 on the preceding page) for approx. 2 seconds until the LED blinks red briefly and then switches to double green flashes.
10. On the **Repeater** page, check the box to the left of the Idx and then click on **Register Repeater(s)**.

**Repeaters**

[Add Repeater](#)

[Refresh](#)

[Stop Registration](#)

	Idx	RPN	Name/ IPEI	DECT sync source	DECT sync mode	State	FW Info	FWU Progress
<input type="checkbox"/>	1	RPN01	M5_01/016E8	RPN00 (-54dBm)	Local Automatical	Present@RPN00	33	Off
<input checked="" type="checkbox"/>	2	RPN02	M5-02/FFFFFFFF	RPN01 (-∞dBm)	Manually	Enabled		

[Check All / Uncheck All](#)

With selected: [Delete Repeater\(s\)](#) [Register Repeater\(s\)](#) [Deregister Repeater\(s\)](#)

Fig. 10

Upon successful registration, the **Repeater** page will show the RPNs of the repeater and its DECT sync source and the state as "Enabled".

**Repeaters**

[Add Repeater](#)

[Refresh](#)

[Stop Registration](#)

	Idx	RPN	Name/ IPEI	DECT sync source	DECT sync mode	State	FW Info	FWU Progress
<input type="checkbox"/>	1	RPN01	M5_01/016E8	RPN00 (-54dBm)	Local Automatical	Present@RPN00	33	Off
<input type="checkbox"/>	2	RPN02	M5-02/016E8	RPN01 (-28dBm)	Manually	Enabled	33.3	Off

[Check All / Uncheck All](#)

With selected: [Delete Repeater\(s\)](#) [Register Repeater\(s\)](#) [Deregister Repeater\(s\)](#)

Fig. 11



## Emergency alarm

Available as of FW v3.24 B0007. Seven emergency alarm profiles can be configured on this page. All configured emergency alarm settings can be selected individually for any handset registered at the base station if that handset has an emergency alarm function. After an emergency alarm profile has been configured in this menu, it can be selected for individual handsets on the handset page.

**Note:** All features of the emergency alarm settings are available on the M85 only. The M65 can be enabled to send an alarm call to the specified alarm number using the factory settings. The M25 does not have an emergency alarm.

### Alarm

Idx	Profile Alias	Alarm Type	Alarm Signal	Stop Alarm from Handset	Trigger Delay	Stop Pre-Alarm from Handset	Pre-Alarm Delay	Howling
0		Alarm Button ▾	Call ▾	Disabled ▾	0	Enabled ▾	30	Enabled ▾
1		Disabled ▾	Call ▾	Enabled ▾	0	Enabled ▾	0	Disabled ▾
2		Disabled ▾	Call ▾	Enabled ▾	0	Enabled ▾	0	Enabled ▾
3		Disabled ▾	Call ▾	Enabled ▾	0	Enabled ▾	0	Disabled ▾
4		Disabled ▾	Call ▾	Enabled ▾	0	Enabled ▾	0	Disabled ▾
5		Disabled ▾	Call ▾	Enabled ▾	0	Enabled ▾	0	Disabled ▾
6		Disabled ▾	Call ▾	Enabled ▾	0	Enabled ▾	0	Disabled ▾
7		Disabled ▾	Call ▾	Enabled ▾	0	Enabled ▾	0	Disabled ▾

Save

Cancel

- **Profile alias.** Optional name for alarm profile; will be added to profile number in parentheses.
- **Alarm type.** Select **Alarm Button** from the drop-down menu to enable the alarm feature. Default setting: Disabled.
- **Alarm signal.** The **Call** setting is mandatory. When the alarm button on the handset is pressed, the handset will call the phone number specified in the handset's Alarm settings (see "Selecting Emergency Alarm Setting on M700" on page 31 or "Selecting Emergency Alarm Setting on M300" on page 35, respectively).

The following settings apply to the M85 only. The M65 uses the default settings regardless of the setting, except for **Howling** which is available on the M85 only.

- **Stop Alarm from Handset.** This setting establishes whether or not an alarm can be cancelled from the handset. Default setting: Enabled.
- **Trigger Delay.** Enter the number of seconds from the moment the handset's alarm button is pressed that the handset will wait before calling the alarm number or, if a pre-alarm delay has also been configured, before the pre-alarm delay is triggered. Default setting: 0.
- **Stop Pre-Alarm from Handset.** This setting establishes whether or not a pre-alarm can be cancelled from the handset. Default setting: Enabled.
- **Pre-Alarm Delay.** Enter the number of seconds from the moment the handset's alarm button is pressed that the handset will wait before calling the alarm number. The display will show the "Pre-alarm triggered" message, and the emergency ringer, if set, will be played. Default setting: 0.
- **Howling (M85 only).** This setting establishes whether or not the handset will emit a howl while it is dialing the emergency number. Default setting: Enabled.

# Central Directory

The central directory is accessible from all handsets registered at the same base station or in the same multicell installation. The central directory can be a phone list downloaded to the base station or an external source like the company LDAP register. It is not possible to add or delete entries or to edit existing entries on the base station's web interface or on the handsets.

**Central Directory**

Location:

Server:

Filename:

Phonebook reload interval (s):

---

**Import Central Directory:**

Filename:  No file selected.

Fig. 1

## Local Phone Directory

The **local** central directory is a phone list downloaded to the base station or to the primary base station in a multicell installation.

**Note:** The list cannot be edited on the base station's web interface or on the handsets.

If you need to edit existing entries or if you want to add or delete entries, you must do so in the original file and download it anew. The entire saved file is overwritten every time you load a file to the central directory.

## Preparing the Phone Directory File

The local central directory loaded onto the base station must adhere to one of two formats. If there is only one phone number for every name, you can use list type 1. If some of the entries have more than one phone number associated with a name, use list type 2.

### List Type 1

This is a text file containing a list of entries with comma-separated values. Each entry consists of a name and a phone number. Save the file on your PC or on a server as a normal text file (\*.txt).

Valid values:

- Name: A total of 23 characters.
  - The comma (,) is not allowed because it serves to separate the name and number values of each entry. Entries with more than one comma-separator will be discarded without warning.
  - Names with more than 23 characters will be truncated.

- Number: A total of 21 characters.
  - Valid characters: Digits 0 to 9 and the symbol +. You can use parentheses () around area codes and/or blank spaces to partition numbers into segments, but they will not be shown on the handset.
  - Numbers with more than 21 characters will be discarded without warning.

Examples for valid entries:

Mark,9345  
 Jack,+4930111111111  
 Kurt Maier (snom),8745  
 Mary Miller,9856  
 Miller Mary,9856  
 Dr. Smith,(917)5550145  
 Dr. Smith,917 555 0145  
 Tim Meier,(040)111111111



Examples for invalid entries that will be discarded:

Dr. Smith,917-5550145      *(hyphen in number invalid)*  
 Jack,030-11111111      *(hyphen in number invalid)*  
 Miller,Mary,9856      *(comma separating last and first name is invalid)*

## List Type 2

This is a list using the format of XML elements. Each entry consists of a name and up to three phone numbers. **If a name has less than three numbers, do not remove the XML element(s)** themselves; just leave the value(s) blank. Save the file on your PC or on a server as "all types" (\*.\*) or as a text file (\*.txt).

Three phone numbers per name are possible. If more than one number is available for a given name, they can be selected by pressing the right navigation key on the handset.

- Telephone. This is interpreted by the handset as the home phone number represented by the  symbol. If there are no office or mobile numbers, the home number is presented by the handset when you select the name.
- Office. This is interpreted by the handset as the work phone number represented by the  symbol. If entered, the work number is the number presented by the handset when you select the name.
- Mobile. This is interpreted by the handset as the mobile phone number represented by the  symbol. If entered and if there is no office number, the mobile number is the number presented by the phone when you select the name.

**Note:** Type the phone number with any required prefixes (area code, country code, operator/auto attendant, etc.). Only the digits 0 to 9 are allowed; do not use spaces, parentheses, punctuation, or other characters between the digits.

Required elements:

```
<IPPhoneDirectory>
<DirectoryEntry>
<Name></Name>
<Telephone></Telephone>
<Office></Office>
<Mobile></Mobile>
</DirectoryEntry>
</IPPhoneDirectory>
```

The indentations in the following example, a phone list with five names, are only for demonstration purposes to set the individual entries apart.

```
<IPPhoneDirectory>
  <DirectoryEntry>
    <Name>Name1</Name>
    <Telephone>phone number 1</Telephone>
    <Office>office phone number 1</Office>->
    <Mobile>mobile phone number 1</Mobile>
  </DirectoryEntry>
  <DirectoryEntry>
    <Name>Name2</Name>
    <Telephone></Telephone>
    <Office>office phone number 2</Office>
    <Mobile></Mobile>
  </DirectoryEntry>
  <DirectoryEntry>
    <Name>Name3</Name>
    <Telephone>phone number 3</Telephone>
    <Office> office phone number 3 </Office>
    <Mobile></Mobile>
  </DirectoryEntry>
  <DirectoryEntry>
    <Name>Name4</Name>
    <Telephone>phone number 4</Telephone>
    <Office></Office>
    <Mobile> mobile phone number 4</Mobile>
  </DirectoryEntry>
  <DirectoryEntry>
    <Name>Name5</Name>
    <Telephone>phone number 5</Telephone>
    <Office></Office>
    <Mobile> </Mobile>>
  </DirectoryEntry>
</IPPhoneDirectory>
```

*Work (office) number is default number first shown*



*Work number is default number first shown*



*Work number is default number first shown*



*No work number, mobile number is shown*



*No work or mobile number, home phone number is shown*



## Downloading the Phone Directory File

1. After preparing and saving the file as described in "Preparing the Phone Directory File", click on **Browse** (Fig. 1) and select the file on your PC or server (Fig. 2). The name of the file will appear to the right of the **Browse** button (Fig. 3).

### Central Directory

Location:

Server:

Filename:

Phonebook reload interval (s):

### Import Central Directory:

Filename:  No file selected.

Fig. 1

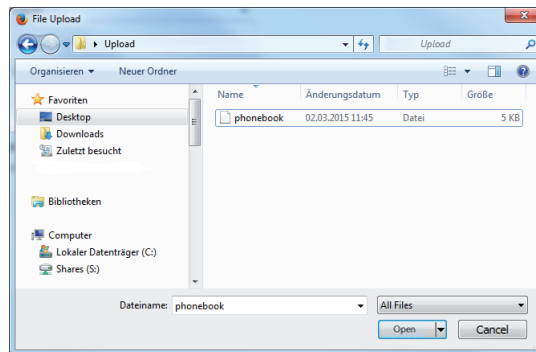

Fig. 2

### Central Directory

Location:

Server:

Filename:

Phonebook reload interval (s):

### Import Central Directory:

Filename:  phonebook

Fig. 3

2. Click on **Load** (Fig. 3).
3. Reboot the base station to make sure that the changes take effect.

After the file has been downloaded to the base station, the name of the file is not visible on the **Central Directory** page anymore. You can view the contents of the imported file on the registered handsets, but not on the base station.

## LDAP

On the **Central Directory** page, select **LDAP** from the drop-down menu of **Location** (see Fig. 1 on page 42) to open the LDAP server menu (Fig. 1, below). After saving your input, you may want to reboot the base station to make sure that the changes take effect.

Fig. 1

Fig. 2

### Settings:

- Server: IP address of the LDAP server
- Port: Server port for LDAP
- Sbase: This setting specifies the LDAP search base (the distinguished name of the search base object) which corresponds to the location in the directory from which the LDAP search is requested to begin. The criteria depend on the configuration of the LDAP server.
- LDAP Filter: LDAP name filter is the search criteria for name look-ups. The format of the search filter is compliant to the standard string representations of LDAP search filters (RFC 2254). The default value is blank.
- Bind: Specifies the bind "username" for LDAP servers when the handset connects to the server. If the server allows anonymous binds, you can leave the setting blank.
- Password: Specifies the bind "password" for LDAP servers. If the server allows anonymous binds, you can leave the setting blank.
- Virtual Lists: If your LDAP server does not support server-side result pagination and sorting (VLV extension), select "disabled" from the drop-down list.
- Handset identity settings.
  - Name: Select the LDAP name attribute from the drop-down menu. The options are cn and sn+givenName. The default setting is cn.
  - LDAP number attributes: The attributes telephoneNumber, mobile, and homePhone are preset.

# Firmware Update

When first installing the base station, Snom recommends updating to the latest firmware version. Please go to [www.snom.com](http://www.snom.com) to see if a new version is available and to download it.

You can either use the Snom M series update server or download the files to your own server and update the firmware from there.

**Note:** We recommend to always operate the base station and the connected wireless devices with the same firmware version.

Although it is possible to update an active live system, we cannot guarantee its uninterrupted functionality. We therefore recommend performing wireless updates when the whole system is idle.

## Considerations before updating

- On average, it takes 10 - 15 minutes to transmit the firmware file to the wireless devices, but it could take up to 60 minutes depending on traffic (voice traffic has priority).
- Using a handset will pause the transfer process to it. It will continue once the handset is back in idle mode.
- Once the firmware has been transferred, the actual update of each wireless device takes approx. one minute.
- The M700 can update up to 10, the M300 up to 5 wireless devices at a time. If more devices are registered with the base, they will be updated successively.

**Note:** The base station randomly selects the devices for firmware transfer. It is not possible to assign priority to certain devices.

- Repeaters will start updating automatically when there are no ongoing calls, resulting in a service interruption of approx. one minute.
- Multicell installations.
  - The M700 will update all handsets in range, including devices registered on another base station.
  - When a user moves from within the range of one base station to another, the update will continue as long as sufficient update capacity is available.
  - When a multicell installation is fully occupied with firmware transfers, handover/roaming will fail, i.e., active calls may be lost.
  - When an update is initiated on one base station, all base stations will perform an update.

## Updating manually

Manual updates are performed in several steps: Downloading the update files for registered wireless devices to the base station and transmitting them from the base station to the devices, updating the base station, and updating the handsets by placing them in their chargers.

## Using Snom's update server

Please go to [http://wiki.snom.com/FAQ/snom\\_M/update\\_using\\_dect\\_snom\\_com](http://wiki.snom.com/FAQ/snom_M/update_using_dect_snom_com) for the description on how to use Snom's update server and for downloading the latest firmware versions to your device(s).

## Using your own server

Before starting the update, you must download all required files and save them in folders using the exact structure described below.

Do not rename the update files as the base station will look for file names that adhere to the M-series naming scheme. All M-series product names start with a capital M, followed by one to three numerals. The names of the firmware files also start with the capital M and are followed by one to three numerals, i.e., M700, M65, M5, etc. The product name is followed by the underscore \_ which, in turn, is followed by a small v and the three-digit firmware version preceded by a zero, i.e., 0324, 0355, etc.

Examples:

- The update file for updating the M700 to version 355 must be named **M700\_v0355.fwu**.
- The update file for updating the M65 to version 355 must be named **M65\_v0355.fwu**.

## Downloading update files to your server

1. Set up a folder for each M-series product on your http server.

Name	Date modified	Type
M5	05.09.2014 10:46	File folder
M25	05.09.2014 10:36	File folder
M65	05.09.2014 10:34	File folder
M300	05.09.2014 10:46	File folder
M700	05.09.2014 10:34	File folder

**Note:** Linux/Unix based HTTP servers are case-sensitive. Since all M-series product names start with a capital M, the names of the folders must also start with a capital M, i.e., M700, M65, etc. Naming the folders m700, m65, etc. will cause the downloads to fail.

2. Download the firmware file for each product you want to update into the respective folder. It is possible to store multiple firmware versions in a product folder; it is therefore not necessary to delete older firmware versions before downloading.

Name	Date modified	Type
M700_v0316.fwu	29.08.2014 08:56	FWU File
M700_v0317.fwu	29.08.2014 08:56	FWU File
M700_v0318.fwu	29.08.2014 08:56	FWU File



**Downloading update files to base station and transmitting to wireless devices**

**Firmware Update Settings**

Firmware update server address:

Firmware path:

Type: M25, M65

Required Version: 323, 0

**Update Base Stations**

Update this Base Station only  
 Update all Base Stations

Required Version:

1. Open the web user interface of the base station and click on **Firmware Update** in the menu on the left side.
2. In the section **Firmware Update Settings**, enter the address of your server in the text field of **Firmware update server address**.
3. Enter the firmware path in the text field of **Firmware path** or leave blank, depending on your setup.
4. The **Type** section lists all types of the wireless devices currently registered at the base, i.e., M65, M25, M5, etc. Any types of device not currently registered will not be listed. Enter the three-digit firmware version, i.e., 323, 324, 0355, etc., in the text field of each respective wireless product.
5. Click on **Save/Start Update**. The base station will download the firmware and transmit it to the wireless devices. You can monitor the progress of the transfer to each registered handset on the **Extensions** page.
  - a. Handsets will not perform the update until the next time they are placed in the charger.

**Note:** On average, it takes 10 - 15 minutes to transmit the firmware file to the handset, but it could take up to 60 minutes depending on traffic (voice traffic has priority).

The transmission of the file to the handset will pause when the handset is used and continue as soon as it is idle again.

	Idx	IPEI	Handset State	FW Info	FWU Progress
<input type="checkbox"/>	0	018870DF2A	Present@RPN00	08/08/14 14:48	6%

Progress of firmware transfer in %; LED on handset is blinking red.

	Idx	IPEI	Handset State	FW Info	FWU Progress
<input type="checkbox"/>	0	018870DF2A	Present@RPN00	08/08/14 14:48	Verifying 27%

Firmware has been transferred and is being verified (progress in %).

	<u>Idx</u>	<u>IPEI</u>	<u>Handset State</u>	<u>FW Info</u>	<u>FWU Progress</u>
<input type="checkbox"/>	0	018870DF2A	Present@RPN00	08/08/14 14:48	Waiting for charger

*Firmware transfer has been completed; update will start the next time the handset is placed in the charger.*

- b. Repeaters will perform the update as soon as there are no active calls in the system.

**Updating the base station**

6. In the Update Base Stations section, click on one of the radio buttons. The default is **Update this Base Station Only**.
7. Enter the three-digit firmware version for updating the base station in the text field of **Required Version**, i.e., 323,324, etc.
8. Click on **Start Update**.

**Updating registered handsets**

You have provided the firmware to the handsets registered at the base station in steps 4 and 5, above. The update of each handset will be performed the next time it is placed in the charger and will take approximately one minute.

9. Place the handset in the charger to start the firmware update. The LED will flash rapidly, first green, then red.

If the update was successful, the handset will turn on again, and the web interface will indicate the completion of the update and the current firmware version on the handset.

	<u>Idx</u>	<u>IPEI</u>	<u>Handset State</u>	<u>FW Info</u>	<u>FWU Progress</u>
<input type="checkbox"/>	0	018870DF2A	Present@RPN00	318.9	Complete

## Provisioning updates

Please see the separate **Provisioning Guide M700/M300** in our [Wiki](#).

# Description of Settings

## Home/Status

The Home/Status page contains the summary of current operating condition and the settings of the base station and the handsets registered at the base station. It also contains the buttons for rebooting the base station.

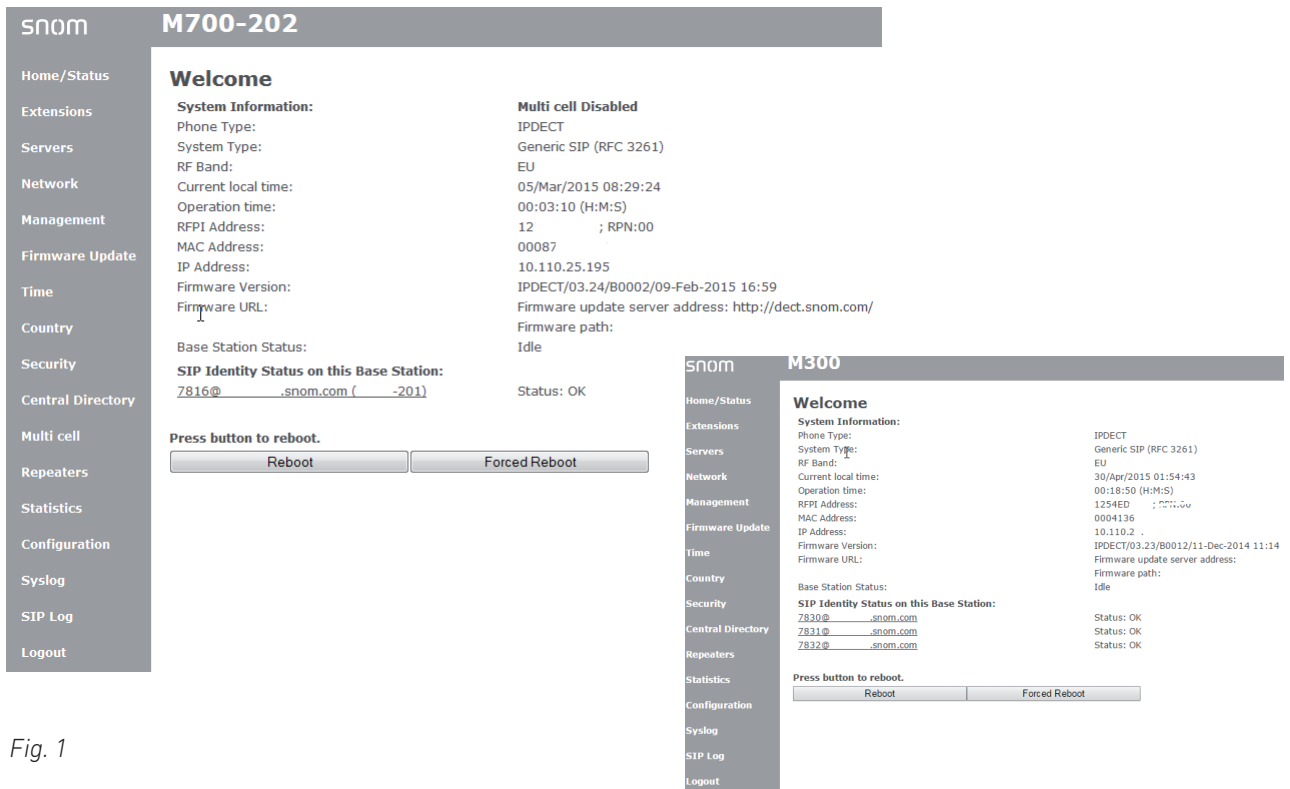

Fig. 1

Description of information on this page:

- System information: This base station's current multicell state (disabled, primary base station in multicell installation, secondary base station in multicell installation).

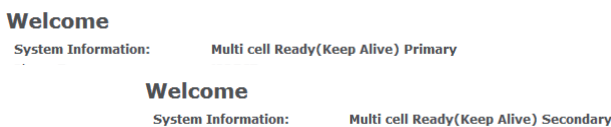

Fig. 2

- Phone type: IP DECT
- System type: Custom configuration, if any. Default: Generic SIP (RFC 3261)
- RF band: Depending on location (EU, US, LATAM)
- Current local time
- Operation time: Counter - time elapsed since last reboot of base

- RFPI address: RFPI: The Radio Fixed Part Identity is a unique identifier frequently transmitted by the base station.
- MAC address: The media access control (MAC) address is a unique identifier assigned by the manufacturer.
- IP address: The Internet Protocol address assigned by the network the base station is located in.
- Firmware version:
- Firmware URL: The address of the server from which firmware updates can be downloaded.
- Base station status: In use or Idle
- SIP identity status on this base station. This is the status of the handsets registered and currently present at this base station. Note: Handsets that are currently turned off are not shown; you can still view them on the Extensions page, showing their state as "detached". Error messages may differ, depending on the setup of your PBX.
- Reboot button: Clicking on this button will initiate a reboot as soon as the base station is idle, i.e., when there are no current calls, handsets accessing the directory, or ongoing firmware updates.
- Forced reboot button: Clicking on this button will initiate an immediate reboot; active calls, firmware updates, and directory access from all handsets will be terminated immediately.



Fig. 3

# Extensions

## M700

This page has three subpages, **Add Extension**, **Edit Extension**, and **Handset**. Setting up extensions and registering handsets to extensions: See "Extensions" on page 53 ff.

### Note:

- An extension/identity can only be assigned to one handset in your single-cell or multicell installation. Do not try to register more than one handset for an extension.
- Each handset will only support **one identity per SIP server**, regardless whether the servers are in your office network or provided externally by an IP provider.

### Extensions

[Add extension](#)  
[Stop Registration](#)

	Idx	IPEI	Handset State	Handset Type FW Info	FWU Progress		VoIP Idx	Extension	Display Name	Server	Server Alias	State
<input checked="" type="checkbox"/>	1	02523	Detached			<input type="checkbox"/>	1	7816		.snom.com	-201	
<a href="#">Check All / Uncheck All</a>							<a href="#">Check All Extensions / Uncheck All Extensions</a>					

*With selected:* [Delete Handset\(s\)](#) [Register Handset\(s\)](#) [Deregister Handset\(s\)](#) [Start SIP Registration\(s\)](#) [SIP Delete Extension\(s\)](#)

Fig. 1

### Extensions page settings

Setting	Description
Idx	Index of handsets. Handsets are numbered consecutively by the base station. With checkbox for registering handsets at and deregistering or deleting them from the base station.
IPEI	International Portable Equipment Identifier for DECT handsets which is unique worldwide. It consists of the equipment manufacturer code (EMC) and a portable serial number (PSN) issued by the manufacturer.
Handset State	Information on the respective handset's current status in the network: <b>Present@RPNxx:</b> The handset is located at the base station with RPNxx (radio fixed part number). <b>Detached:</b> The handset is turned off. <b>Located:</b> The handset is configured to locate on a specific base station, but is unable to do so (e.g., the base station is turned off). <b>Removed:</b> The handset has not been used for a specified amount of time. <b>Enabled:</b> Registration has been set up for handset, but handset has not registered yet.
Handset Type FW Info	Type of handset (e.g., M65) and firmware version (e.g., 324.7) on the handset

Setting	Description
FWU Progress	During a firmware update, this field displays the update's progress. <b>Off:</b> No update in progress <b>Initializing:</b> Update is starting <b>x%:</b> Update in progress, x percent done <b>Verifying x%:</b> Update writing completed, FW verification ongoing <b>Waiting for charger:</b> Firmware has been transmitted to handset; update will begin when handset is placed in charger. <b>Conn. term.wait:</b> Firmware has been transmitted to repeater; update will begin when system is idle. <b>Complete:</b> Firmware on handset/repeater has been updated <b>Error:</b> Unable to update (file not found, file invalid etc.)
VoIP Idx	Index of configured SIP extensions, numbered consecutively by the base station. With checkbox for selecting the extension for SIP registration and deregistration.
Extension	The extension number that is also shown on the handset's display
Display Name	Optional. If entered, the name will be shown on the handset's display.
Server	The server selected on the <b>Add extension/Edit extension</b> page.
Server Alias	The server alias set on the <b>Servers</b> page.
State	SIP registration state. If the field is empty, the handset is not SIP-registered.

**Add/Edit Extension settings**

These pages are used to configure new extensions and to edit existing ones, respectively. The two pages contain the same settings. **Handset** selection, **Extension** setting, and **Server** selection are mandatory. The remaining settings depend on the requirements of your PBX or VoIP provider and can be left blank, if nothing is required.

- To open the **Add extension** page, click on **Add extension** (Fig. 2).
- To open the **Edit extension** page, click on the **Extension** number (Fig. 2).

**Extensions**

[Add extension](#)  
Stop Registration

	Idx	IPEI	Handset State	Handset Type FW Info	FWU Progress		VoIP Idx	Extension	Display Name	Server	Server Alias	State
<input checked="" type="checkbox"/>	1	02523	Detached			<input type="checkbox"/>	1	7816		.snom.com	-201	

[Check All / Uncheck All](#)
[Check All Extensions / Uncheck All Extensions](#)

With selected: [Delete Handset\(s\)](#) [Register Handset\(s\)](#) [Deregister Handset\(s\)](#) [Start SIP Registration\(s\)](#) [SIP Delete Extension\(s\)](#)

Fig. 2

**Edit extension**

<p>Line name: <input type="text"/></p> <p>Handset: <input type="text" value="Handset Idx 1"/></p> <p>Extension: <input type="text" value="7816"/></p> <p>Authentication User Name: <input type="text"/></p> <p>Authentication Password: <input type="text"/></p> <p>Display Name: <input type="text"/></p> <p>PIN: <input type="text" value="••••"/></p> <p>Mailbox Name: <input type="text" value="7816"/></p> <p>Mailbox Number: <input type="text" value="7816"/></p> <p>Server: <input type="text" value="ser-fx-201: .com"/></p> <p>Call waiting feature: <input type="text" value="Enabled"/></p> <p>BroadWorks Shared Call Appearance: <input type="text" value="Disabled"/></p> <p>Broadsoft Feature Event Package: <input type="text" value="Disabled"/></p> <p>Forwarding Unconditional Number: <input type="text"/></p> <p>Forwarding No Answer Number: <input type="text" value="90"/> s</p> <p>Forwarding on Busy Number: <input type="text" value="Disabled"/></p>	<p><b>Edit extension</b></p> <p>Line name: <input type="text"/></p> <p>Handset: <input type="text" value="Handset Idx 1"/></p> <p>Extension: <input type="text"/></p> <p>Authentication User Name: <input type="text"/></p>
--	---

Fig. 3

Parameter descriptions for **Add extension** and **Edit Extension** subpages:

Setting	Description
Line name	As required/desired. Specifies the line name for this extension on the handset. Used when user must select a line for outgoing calls.
Handset	Select New Handset or one of the available Handset IDXs
Extension	Extension number or SIP username, as configured in PBX or on SIP server.
Authentication User Name	As required by PBX or VoIP provider
Authentication Password	As required by PBX or VoIP provider
Display Name	As required or desired
PIN	This is the PIN for accessing the mailbox, if required by PBX or VoIP provider and if a mailbox is available. <b>Note:</b> This PIN is not to be confused with <u>either</u> the access code for registering the handset at the base station <u>or</u> the PIN for resetting the handset to factory values or for deregistering it from the base station.
Mailbox Name	If mailbox available on PBX or provided by VoIP provider. If no mailbox name is set, same as mailbox number.
Mailbox Number	If mailbox available on PBX or provided by VoIP provider. Often the same as the extension number. Accessing mailbox: Long-press key 1 on handset to connect to mailbox.
Server	Select server from drop-down menu
Call waiting feature	Turn call waiting on/off. Default: Enabled (on).
Broadsoft Feature Event Package	On/off. Applicable only to Broadsoft applications. If enabled, the extension subscribes to the Broadsoft Application Server Feature Event Package and is ready to receive SIP Notify with status for the Broadsoft server services "do not disturb (DND)" and "call forwarding" (always, busy, no answer) .

Setting	Description
Forwarding Unconditional Number	On/off. All incoming calls for this extension will be forwarded to the number entered in the text field. <b>Note:</b> This setting (both the number and the enabled/disabled status) can be changed from the handset registered to the extension. <b>Defaults:</b> Empty number field, status disabled
Forwarding No Answer Number	On/off. Incoming calls for this extension will be forwarded to the number entered in the text field if not picked up after the number of seconds entered in the adjacent field. <b>Note:</b> This setting (both the number and the enabled/disabled status) can be changed from the handset registered to the extension. <b>Defaults:</b> Empty number field, status disable
Forwarding on Busy Number	On/off. Incoming calls for this extension will be forwarded to the number entered in the text field when the line is busy. <b>Note:</b> This setting (both the number and the enabled/disabled status) can be changed from the handset registered to the extension. <b>Defaults:</b> Empty number field, status disable

**Handset settings**

Click on the IPEI or the place holder FFFFFFFF to open the subpage. If you click on the IPEI of a registered handset, the handset model (M65, M85, or M25) is added to the title of the page (Fig. 5).

**Extensions**

[Add extension](#)  
[Stop Registration](#)

	Idx	IPEI	Handset State	Handset Type FW Info	FWU Progress	VoIP Idx	Extension	Display Name	Server	Server Alias	State
<input type="checkbox"/>	1	0253C	Present@RPN00	M65 316.2	Off	<input type="checkbox"/> 1	7816		.nom.com	-fx-201	SIP Registered@RPN00
<input type="checkbox"/>	2	0253F	Present@RPN00	M25 323.11	Off	<input type="checkbox"/> 2	7820		.snom.com	-fx-201	SIP Registered@RPN00
<input type="checkbox"/>	3	FFFFFFFF				<input type="checkbox"/> 3	7821		.snom.com	-fx-201	

[Check All / Uncheck All](#)
[Check All Extensions / Uncheck All Extensions](#)

With selected: [Delete Handset\(s\)](#) [Register Handset\(s\)](#) [Deregister Handset\(s\)](#) [Start SIP Registration\(s\)](#) [SIP Delete Extension\(s\)](#)

Fig. 4

**Handset (M65)**

Location:

IPEI:

AC:

Alarm Line:

Alarm Number:

Fig. 5

**Handset**

Location:

IPEI:

AC:

Alarm Line:

Alarm Number:

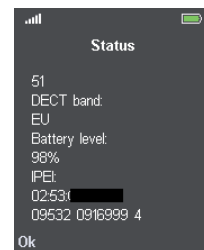

Fig. 6



Parameter descriptions for **Handset** subpages:

Setting	Description
Location	In multicell installations, select from drop-down menu if more than one base-station available
IPEI	To find the IPEI, open the <b>Settings</b> menu of the handset, select <b>Status</b> , and scroll down to the IPEI at the end of the handset status. The IPEI consists of a string of 10 decimals and capital letters. Do not enter the colons grouping the characters of the string into twos.



Setting	Description
AC	This is the access code for registering the handset at the base station. The default is 0000 (four times zero). <b>NOTE:</b> This access code is not to be confused with <u>either</u> the PIN for resetting the handset to factory values or for deregistering it from the base station (default also 0000) <u>or</u> the PIN for accessing the mailbox.
Alarm Line	M85/M65. This is the extension number the handset is registered for.
Alarm Number	M85/M65. This is the phone number the handset will call when the emergency alarm button is pressed.
<b>Alarm Profiles</b> (alarm button configurable for M65 and M85; not available on M25). For more information, see "Emergency alarm" on page 41 and "Alarm" on page 82.	
Profile	If an alarm profile has been configured on the <b>Alarm</b> page and a profile alias was assigned, it will be shown in parentheses following the number of the profile (i.e, Profile 0 (Shop)). Click on the checkbox of a profile to select.
Alarm Type	If an alarm profile has been configured on the <b>Alarm</b> page, this item will say <b>Alarm Button</b> .
<b>Import Local Phonebook</b>	
<p>These are the individual contacts stored on your handset only and accessible via the  symbol on the handset's display.</p> <p><b>Note:</b> Not to be confused with the "local" phone directory downloaded onto the base station via the <b>Central Directory</b> page and accessible via the  symbol on all handsets registered at the base station (see "Local Phone Directory" on page 42).</p> <p>Click on <b>Browse</b> and select the file from directory of your PC, then click on <b>Load</b>. The file must adhere to the same formats as those for the local central directory (see "Preparing the Phone Directory File" on page 42 ).</p>	
<b>Export Local Phonebook</b>	
<p>These are the individual contacts on your handset, accessible via the  symbol on the handset's display. The file is exported to your PC as a comma-separated values (csv) file.</p>	

## M300

### Extensions and Handset page settings

The larger script of either **Extensions** or **Handset** indicates which settings are displayed on-screen.

- Extension settings are on-screen: [Extensions / Handset](#)

Setting	Description
Idx	Index of extensions. Extensions are numbered consecutively by the base station. With checkbox for starting and deleting SIP registrations.
Extension	The extension number that is shown on the handset's display
Display Name	Optional. If entered, the name will be shown on the handset's display.
Server	The server selected on the <b>Add extension/Edit extension</b> page.
Server Alias	The server alias set on the <b>Servers</b> page.
State	SIP registration state. If the field is empty, the handset is not SIP-registered.
IPEI	International Portable Equipment Identifier for DECT handsets which is unique worldwide. It consists of the equipment manufacturer code (EMC) and a portable serial number (PSN) issued by the manufacturer.

## Add/Edit Extension settings

Except for the title at the top of the page, the **Add Extension** page and the **Edit Extension** page have the same content. To open **Add Extension**, click on the **Add Extension** button on the **Extensions and Handset** page; to open **Edit Extension**, click on the extension.

Setting	Description
Extension	Extension number or SIP username, as configured in PBX or on SIP server.
Authentication User Name	As required by PBX or VoIP provider
Authentication Password	As required by PBX or VoIP provider
Display Name	As required or desired
PIN	This is the PIN for accessing the mailbox, if required by PBX or VoIP provider and if a mailbox is available. <b>Note:</b> This PIN is not to be confused with <u>either</u> the access code for registering the handset at the base station <u>or</u> the PIN for resetting the handset to factory values or for deregistering it from the base station.
Mailbox Name	If mailbox available on PBX or provided by VoIP provider. If no mailbox name is set, same as mailbox number.
Mailbox Number	If mailbox available on PBX or provided by VoIP provider. Often the same as the extension number. Accessing mailbox: Long-press key 1 on handset to connect to mailbox.
Server	Select server from drop-down menu
Call waiting feature	Turn call waiting on/off. Default: Enabled (on).
Forwarding Unconditional Number	On/off. All incoming calls for this extension will be forwarded to the number entered in the text field. <b>Note:</b> This setting (both the number and the enabled/disabled status) can be changed from the handset registered to the extension. <b>Defaults:</b> Empty number field, status disabled
Forwarding No Answer Number	On/off. Incoming calls for this extension will be forwarded to the number entered in the text field if not picked up after the number of seconds entered in the adjacent field. <b>Note:</b> This setting (both the number and the enabled/disabled status) can be changed from the handset registered to the extension. <b>Defaults:</b> Empty number field, status disable
Forwarding on Busy Number	On/off. Incoming calls for this extension will be forwarded to the number entered in the text field when the line is busy. <b>Note:</b> This setting (both the number and the enabled/disabled status) can be changed from the handset registered to the extension. <b>Defaults:</b> Empty number field, status disable
<b>Select Handset(s) table</b>	
Idx	Select New Handset or one or more of the available handset IDXs by clicking on the respective checkbox(es)
IPEI	International Portable Equipment Identifier for DECT handsets which is unique worldwide. It consists of the equipment manufacturer code (EMC) and a portable serial number (PSN) issued by the manufacturer.



- Handset settings are on-screen: [Extensions / Handset](#)

Setting	Description
Idx	Index of handsets. Handsets are numbered consecutively by the base station. With checkbox for registering handsets at and deregistering or deleting them from the base station.
IPEI	International Portable Equipment Identifier for DECT handsets which is unique worldwide. It consists of the equipment manufacturer code (EMC) and a portable serial number (PSN) issued by the manufacturer.
Handset State	Present, detached, located, removed, enabled,. <b>Present@RPNxx:</b> The handset is located at the base station with RPNxx (radio fixed part number). <b>Detached:</b> The handset is turned off. <b>Located:</b> The handset is configured to locate on a specific base station, but is unable to do so (e.g., the base station is turned off). <b>Removed:</b> The handset has not been used for a specified amount of time. <b>Enabled:</b> Registration has been set up for handset, but handset has not registered yet.
Handset Type FW Info	Type of handset (e.g., M65) and firmware version (e.g., 324.7) on the handset
FWU Progress	During a firmware update, this field displays the update's progress. <b>Off:</b> No update in progress <b>Initializing:</b> Update is starting <b>x%:</b> Update in progress, x percent done <b>Verifying x%:</b> Update writing completed, FW verification ongoing <b>Waiting for charger:</b> Firmware has been transmitted to handset; update will begin when handset is placed in charger. <b>Conn. term.wait:</b> Firmware has been transmitted to repeater; update will begin when system is idle. <b>Complete:</b> Firmware on handset/repeater has been updated <b>Error:</b> Unable to update (file not found, file invalid etc.)
Extension	The extension number shown on the handset's display

## Handset settings

When you click on **Add Handset**, the **Handset** page opens; the text field for the IPEI contains the place holders FFFF. When you click on the IPEI of a handset, the **Handset** page for editing that handset's settings opens; the text field for the IPEI contains the IPEI's 10-digit string of numerals and capital letters.

Setting	Description
IPEI	International Portable Equipment Identifier for DECT handsets which is unique worldwide. It consists of the equipment manufacturer code (EMC) and a portable serial number (PSN) issued by the manufacturer.
AC	This is the access code for registering the handset at the base station. The default is 0000 (four times zero). <b>NOTE:</b> This access code is not to be confused with <u>either</u> the PIN for resetting the handset to factory values or for deregistering it from the base station (default also 0000) <u>or</u> the PIN for accessing the mailbox.
Alarm Line	As required by PBX or VoIP provider
Alarm Number	As required by PBX or VoIP provider

Setting	Description
<b>Alarm Profiles</b> (alarm button configurable for M65 and M85; not available on M25)	
Profile	If an alarm profile has been configured on the <b>Alarm</b> page and a profile alias was assigned, it will be shown in parentheses following the number of the profile (i.e, Profile 0 (Shop)). Click on the checkbox of a profile to select.
Alarm Type	If an alarm profile has been configured on the <b>Alarm</b> page, this item will say <b>Alarm Button</b> .
<b>Import Local Phonebook</b>	
<p>These are the individual contacts on your handset, accessible via the  symbol on the handset's display.</p> <p><b>Note:</b> Not to be confused with the "local" phone directory downloaded onto the base station via the <b>Central Directory</b> page and accessible via the  symbol on the handset's display (see "Local Phone Directory" on page 42).</p> <p>Click on <b>Browse</b> and select the file from directory of your PC, then click on <b>Load</b>. The file must adhere to the same formats as those for the local central directory (see "Preparing the Phone Directory File" on page 42 ).</p>	
<b>Export Local Phonebook</b>	
<p>These are the individual contacts on your handset, accessible via the  symbol on the handset's display. The file is exported to your PC as a comma-separated values (csv) file.</p>	

# Servers

On this page you add and remove SIP/NAT servers, select the server the base station should connect to, and change the default settings.

Fig. 1

Parameter descriptions:

Setting	Description
Server Alias	Server alias. <b>Default:</b> empty.
NAT Adaptation	<b>Default:</b> Disabled. Ensures that all SIP messages go directly to the NAT gateway. <b>Please note:</b> <b>Enabled:</b> When the base station receives a SIP response to a REGISTER request with a "Via" header that includes the "received" parameter (e.g.: <i>Via: SIP/2.0/UDP 10.1.1.1:4540;received=68.44.20.1</i> ), it will adapt its contact information to the IP address from the "received" parameter. The base station will then send another REGISTER request with the updated contact information. <b>Disabled:</b> The base station will ignore the "received" parameter.
Registrar	SIP server proxy DNS or IP address. Specifying the port number is optional.
Outbound proxy	Session border controller DNS or IP address. Alternatively SIP server outbound proxy address. Set the outbound proxy to the address and port of the private NAT gateway so that SIP messages are sent via this gateway. Format: addr:port <b>Default value:</b> Blank

Setting	Description
Conference server	For Broadsoft conference server only: If the IP address of the server is set in this text field, pressing the handset's conference function key during a call will establish a connection to the conference server. If the field is empty, the system's 3-party local conference is used.
Reregistration time (s)	The "expires" value signaled in SIP REGISTER requests. This value indicates how long the current SIP registration is valid, and hence it specifies the maximum time between SIP registrations for the SIP account. Permitted value(s): Maximum 65636 seconds. A value below 60 seconds is not recommended.
SIP Session Timers	RFC 4028. A "keep-alive" mechanism for calls. The session timer value specifies the maximum time between "keep-alive" or more correctly session refresh signals. If no session refresh is received when the timer expires, the call will be terminated. <b>Default:</b> Enabled.
Session timer value (s)	Default value: 1800 seconds. Permitted values: Minimum 90 sec, maximum 65636 sec. If the setting is disabled, session timers will not be used.
SIP Transport	Default: UDP. Other options: TCP, TLS 1.0
Signal TCP Source Port	When SIP Transport is set to TCP or TLS, respectively, a TCP or TLS connection will be established for each SIP extension. The source port of the connection will be chosen by the TCP stack, and the local SIP port parameter specified in the SIP/RTP settings will not be used. The "Signal TCP Source Port" parameter specifies whether the used source port shall be signaled explicitly in the SIP messages. <b>Default:</b> Enabled.
Use one TCP connection per SIP extension	When using TCP or TLS as SIP transport, choose whether the base station is to establish one TCL or TLS connection for <b>each</b> SIP extension or one TCL or TCS connection that <b>all</b> SIP extensions will use. <b>Note:</b> If TLS is used and the SIP server requires client authentication (i.e., requests a client certificate), this setting must be disabled. Settings: Disabled (one TCL or TLS connection for <b>all</b> SIP extensions); Enabled (one TCL or TLS connection for <b>each</b> SIP extension) <b>Default:</b> Disabled
RTP from own base station	If disabled, the RTP stream will be sent from the base station where the handset is located. If enabled, the RTP stream will always be sent from the base station where the handset is registered. <b>Default:</b> Enabled
Keepalive	<b>Default:</b> Enabled. When enabled, a new keepalive message will be sent out to the Registrar/Proxy port after 30 seconds in order to have the port stay open and the phone remain reachable.
Show extension on handset idle screen	Default: Enabled. When enabled, the extension number is displayed on the idle screen of the handset.
Hold behavior	Specifies the behaviour of the handset hold feature. The options are: RFC 3264: Hold is signaled according to RFC 3264, i.e. the connection information part of the SDP contains the IP address of the endpoint, and the direction attribute is for <i>sendonly</i> , <i>recvonly</i> or <i>inactive</i> streams, depending on the context. RFC 2543: The "old" way of signaling HOLD. The connection information part of the SDP is set to 0.0.0.0, and the direction attribute is <i>sendonly</i> , <i>recvonly</i> or <i>inactive</i> , depending on the context. <b>Default value:</b> RFC 3264.

Setting	Description
Attended transfer behavior	<p>Depending on whether the PBX requires the second call to be active (i.e., not on hold) before the REFER is sent, this setting defines whether pressing the "Transfer" function key on a handset will put the second call on hold.</p> <p>Setting "Hold 2nd Call": Pressing the transfer key puts the second call on hold before REFER is sent.</p> <p>Setting "Do Not Hold 2nd Call": Pressing the transfer key results in sending of REFER without first putting the second call on hold.</p> <p><b>Default:</b> Hold 2nd Call</p>
Use own codec priority	<p>This setting specifies whether the incoming call's codec priority (setting: disabled) or the system's own codec priority (setting: enabled) will be used for the call.</p> <p><b>Default:</b> Disabled</p>
DTMF signaling	<p>This setting specifies how the decimal digits (and '*' and '#') are converted into sounds that share similar characteristics with voice to easily traverse networks designed for voice.</p> <p>SIP INFO: Carries application-level data along SIP signalling path (for example: DTMF digits generated during SIP session <b>or</b> DTMF tones via data packets in the same internet layer as the voice stream, etc.).</p> <p>RFC 2833: DTMF handling for gateways, end systems, and RTP trunks (e.g.: Sending DTMF tones via data packets in different internet layer as the voice stream).</p> <p>Both: Enables SIP INFO and RFC 2833 modes.</p> <p><b>Default:</b> RFC 2833</p>
DTMF payload type	<p>This setting allows the user to specify a value for the DTMF payload type / telephone event (RFC2833).</p> <p><b>Default value:</b> 101</p>
Remote Caller ID Source Priority	<p>SIP information field used for Caller ID source. Options:</p> <p>PAI - FROM FROM ALERT_INFO - PAI - FROM</p>
Enable blind transfer	<p>This setting specifies whether blind transfer of calls is allowed (enabled) or not.</p> <p><b>Default:</b> Enabled</p>
Codec priority	<p>This setting specifies the codec priority for audio compression and transmission. After changing the order of priority with the <b>Up/Down</b> buttons, click on <b>Reset codes</b>.</p> <p><b>NOTE:</b> In a multicell setup, you must also go to the multicell page and click on <b>Reboot chain</b> in order to update the handsets in the multicell installation.</p> <p><b>Options:</b> G.722; G.711A-law, <math>\mu</math>-law; G.726</p> <p><b>NOTE:</b></p> <p>With G.722 in the list, the codec negotiation algorithm is active. This causes the handset setup time to be slightly slower than when G.722 is removed from the list.</p> <p>With G.722 as first priority, the number of simultaneous calls per base station will be reduced from 10 (8) to 4 calls.</p>
RTP packet size	<p>This setting specifies the packet size offered as preferred RTP packet size during RTP packet size negotiation.</p> <p><b>Default value:</b> 20 ms</p>

<b>Setting</b>	<b>Description</b>
Secure RTP	If enabled, RTP will be encrypted (AES-128) using the key negotiated via the SDP protocol at call setup. <b>Default:</b> Disabled.
Secure RTP Auth	If enabled, secure RTP will use authentication of the RTP packages. <b>NOTE:</b> With enabled SRTP authentication, a maximum of 4 concurrent calls per base station is possible in both single-cell and multicell systems. <b>Default:</b> Disabled.
SRTP Crypto Suites	Supported SRTP Crypto Suite: AES_CM_128_HMA_SHA1_32



## Network

Setting	Description
<b>IP settings</b>	
DHCP/Static IP	Allowing changes in protocol for getting a dynamic IP address. When DHCP is enabled, the other IP settings and options are not available. DHCP enabled: IP addresses are allocated from a pool of available addresses. Static IP: IP addresses are manually assigned by the network administrator. <b>Default:</b> DHCP.
IP address	Enter when using static IP address. Not accessible when using DHCP.
Subnet mask	Enter when using static IP address. Not accessible when using DHCP.
Default gateway	Enter IP address of your router when using static IP address. Not accessible when using DHCP.
DNS (Primary)	Enter DNS server address of Internet service provider when using static IP address. Not accessible when using DHCP.
DNS (Secondary)	
<b>VLAN Settings</b>	
	The VLAN settings can be used on a managed network with separate Virtual LANs (VLAN) for sending voice and data traffic. To work on these networks, the base station can tag voice traffic it generates on a specific "voice VLAN" using the IEEE 802.1q specification.
ID	12-bit identification of the 802.1Q VLAN. Permitted value(s): Decimals 0 to 4094. A VLAN ID of 0 is used to identify priority frames and the ID of 4095 (i.e., FFF) is reserved. If 0 is set, there is no VLAN tagging or VLAN discovery through DHCP. <b>Default:</b> 0.
User priority	3-bit value defining user priority. Values are 0 (best effort) and 1 to 7 (lowest to highest priority). The values can be used to prioritize different classes of traffic (voice, video, data, etc.). <b>Default:</b> 0
Synchronization	If enabled, the VLAN ID is automatically synchronized between the base stations in a multicell chain. They will be automatically rebooted during the synchronization. <b>Default:</b> Disabled.
<b>DHCP Options</b>	
Plug-n-play	If enabled: DHCP option 66 is used to automatically provide PBX IP address to base station. <b>Default:</b> Disabled.
<b>NAT Settings</b>	
Enable STUN	<b>Default:</b> Disabled. Enable to use STUN.
STUN server	Permitted value(s): IPv4 values or URL. Currently only IPv4 is supported.
STUN bindtime determine	<b>Default:</b> Disabled.
STUN bindtime guard	Time in seconds. Permitted values: Positive integers. <b>Default:</b> 80.
Enable RPORT	<b>Default:</b> Disabled. Enable to use RPORT in SIP messages.
Keep alive time	The interval in seconds at which the base station sends a keepalive signal to the SIP server to maintain NAT bindings. Permitted values: Positive integers. <b>Default:</b> 90.

Setting	Description
<b>SIP/RTP Settings</b>	
Use different SIP ports	If disabled, the local SIP SIP port parameter specifies the source port used for SIP signaling in the system. If enabled, the local SIP SIP port parameter specifies the source port used for first user agent (UA) instance. Succeeding UAs will get succeeding ports. <b>Default:</b> Disabled.
RTP collision detection	Enabled: If two sources have the same SSRC identifier, the second RTP is discarded. Disabled: SSRC identifiers are not checked; device accepts all sources. <b>Default:</b> Enabled.
Local SIP port	The source port used for SIP signaling. <b>Permitted values:</b> Port number default 5060.
SIP ToS/Qos	Priority of call control signaling traffic based on both IP layers of Type of Service (ToS) byte. ToS is referred to as Quality of Service (QoS) in packet-based networks. <b>Permitted values:</b> Positive integer, default is 0x68.
RTP port	The first RTP port to use for RTP streaming. <b>Permitted values:</b> Port number default 50004 (depending on the setup).
RTP port range	The number of ports that can be used for RTP audio streaming. <b>Permitted values:</b> Positive integer, default is 40.
RTP TOS/QoS	Priority of RTP traffic based on the IP layer ToS byte. ToS is referred to as Quality of Service (QoS) in packet-based networks. See RFC 1349 for details. The "cost" bit is not supported. <ul style="list-style-type: none"> <li>• Bit 7..5 defines precedence</li> <li>• Bit 4..2 defines Type of Service (ToS)</li> <li>• Bit 1..0 are ignored</li> </ul> <b>Permitted values:</b> Port number default 5060.

## Management

This page allows the administrator to configure base stations to perform specific functions such as file transfers, firmware up/downgrades, password management, and SIP/debug logs.

Setting	Description
Base station name	The name of the base station that appears at the top of its web interface and as its name within the base station group and the DECT chain of a multicell installation. <b>Default:</b> The model, i.e., M700 and M300, respectively. If you employ more than base station, it is advisable to give them distinct names, e.g., M700-01, M700-02, M700-reception, or other distinguisher. <b>Maximum number of characters:</b> 35
<b>Settings</b>	
HTTP management username	Permitted value: 8-bit string
HTTP management password	Password for access to the configuration server. HTTP client credentials are formed by HTTP management username and this password. Permitted value: 8-bit string
Enable automatic prefix	<i>Disabled:</i> No automatic prefix added. <i>Enabled:</i> The base station adds the leading digit defined in "Set prefix for outgoing calls". <i>Enabled + fallthrough on * and #:</i> Enables detection of * or # at the first digit of a dialed number. In case of detection, the base station will not add a leading 0 to the dialed number. Examples: <ul style="list-style-type: none"> <li>• 1: dialed number on handset *1234 -&gt; dialed number sent to pbx *1234</li> <li>• 2: dialed number on handset #1234 -&gt; dialed number sent to pbx #1234</li> <li>• 3: dialed number on handset 1234 -&gt; dialed number sent to pbx 01234</li> </ul> <b>Default:</b> Disabled.
Set maximum digits of internal numbers	This setting is used to detect internal numbers. No prefix number will be added to a dialed internal number. <b>Default:</b> 0.
Set prefix for outgoing calls	Prefix number for the enabled automatic prefix feature. <b>Permitted values:</b> 1 to 9999. <b>Default:</b> Empty.
<b>Configuration</b>	
Configuration server address	DNS or IP address of server providing configuration file to base station. <b>Default:</b> Empty. Permitted values: IP address or URL.
Filename	<b>Default:</b> Empty.
<b>Text messaging</b>	
Text messaging	<i>Disable/enable</i> messaging via server, if provided by third-party service. <i>Enable without server:</i> Allow handsets to send messages to other handsets supporting messaging. <b>Default:</b> Disabled.
Text messaging & alarm server	Permitted values: IP address or URL. <b>Default:</b> Empty.
Text messaging port	Port number of message server. <b>Default:</b> 1300.
Text messaging keepalive (m)	Intervals in minutes between keepalive messages. Permitted values: Positive integers. <b>Default:</b> 30.

Setting	Description
Text messaging response (s)	Frequency in seconds of response timeouts. <b>Permitted values:</b> Positive integers. <b>Default:</b> 30.
Text messaging TTL	Text messaging time to live <b>in seconds</b> . <b>Permitted values:</b> Positive integers. <b>Default:</b> 0.
<b>Syslog/SIP Log</b>	
Upload of SIP log	When enabled, low-level SIP debug messages will be saved to the server in the following file format: <MAC_address><Time_Stamp>SIP.log <b>Default:</b> Disabled.
SIP log server address	Permitted values: IP address or URL. <b>Default:</b> Empty.
Syslog level	<i>Off:</i> No data is saved on syslog server <i>Normal operation:</i> Normal operation events (incoming and outgoing calls, handset registration, DECT location, call lost due to busy) as well as critical system errors and general system information are logged. <i>System analyze:</i> Handset roaming and handset firmware updates status in addition to the normal operation messages. <i>Debug:</i> Used by Snom for debug. Should not be enabled during normal operation. <b>Default:</b> Normal operation.
Syslog server IP address	Permitted values: IP address or URL. <b>Default:</b> 0.
Syslog server port	Port number of syslog server. <b>Default:</b> 514.

## Firmware Update

Setting	Description
Firmware update server address	IP address or DNS of update source <b>Valid inputs:</b> URL or IP address. <b>Note:</b> Cannot end with slash / character. <b>Examples:</b> http://dect.snom.com, 10.10.104.41 <b>Default:</b> empty.
Firmware path	If required, location of firmware on server or firmware update server path where firmware update files are located. <b>Note:</b> Must begin with slash / character. <b>Example:</b> /M700_v0355.fwu <b>Default:</b> empty.
Type	All types of handsets and repeaters (i.e., M65, M85, M25, M5) that have been registered at the base station, even when all devices of any type are turned off.
Required version (handsets and repeater)	Version of firmware to be upgraded on handset type or repeater. <b>Note:</b> Value 0 will disable firmware upgrade for handsets and/or repeater. <b>Valid input:</b> 8-bit string <b>Example:</b> 355 <b>Default:</b> 0.
Required version (base station)	Version of firmware to be upgraded on base station. <b>Valid input:</b> 8-bit string <b>Example:</b> 355 <b>Default:</b> empty.
Required branch	E.g., B21, if applicable.
Update this base station only/ Update all base stations	M700 only. In multicell installations, click on the respective radio button if you want to update only the base station whose web interface you are logged into or all base stations in the system.

## Time

The time server is mandatory for a multicell configurations where it supplies the time used for data synchronisation. The time server is also used in the debug logs, for SIP trace information pages, and to determine when to check for new configuration and firmware files.

**Note:** Multicell systems will not work without a configured time server.

When time server parameters are changed, the system must be rebooted. Click on the **Save and Reboot** button. It can take up to 15 minutes before all base stations are synchronized, depending on the number of base stations in the system.

For stand-alone base stations, setting the time server is optional. See also "Language, Country, and Time/Date" on page 26.

Setting	Description
Time server	IP address or DNS name of NTP server <b>Valid inputs:</b> URL or IP address (IPv4 only). <b>Default:</b> empty.
Allow broadcast NTP	Check to use time server. <b>Default:</b> Checked
Refresh time (h)	Time interval in hours within which the time server refreshes. <b>Valid inputs:</b> Positive integers
Set timezone by country/region	When checked, the timezone of the country/region selected on the <b>Country</b> page of the web interface will be used. When unchecked, the timezone (UTC +/-) can be selected manually from the drop-down menu on the <b>Time</b> page. <b>Note:</b> Ticking the checkboxes for <b>Set timezone by country/region</b> and <b>Set DST by country/region</b> on the <b>Country</b> page will result in checking and unchecking the settings on both the <b>Time</b> and the <b>Country</b> page. <b>Default:</b> Checked
Timezone	Select timezone from drop-down menu. <b>Default:</b> Checked The setting is disabled when <b>Set timezone by country/region</b> is checked.
Set DST by country/region	When checked, the DST of the country/region selected on the <b>Country</b> page of the web interface will be used. <b>Note:</b> Ticking the checkboxes for <b>Set timezone by country/region</b> and <b>Set DST by country/region</b> on the <b>Country</b> page will result in checking and unchecking the settings on both the <b>Time</b> and the <b>Country</b> page. <b>Default:</b> Checked
The following settings are disabled when <b>Set DST by country/region</b> is checked. When unchecked, daylight saving time can be configured manually on this page.	
Daylight saving time (DST)	Select disabled, enabled, or automatic from drop-down menu. <b>Enabled:</b> DST starts/ends immediately, none of the following settings are available. <b>Disabled:</b> None of the following settings are available, DST will not be used. <b>Automatic:</b> DST will start and stop automatically on the specified dates. <b>Default:</b> Automatic

Setting	Description
DST fixed by day	<p><b>Use month and date:</b> If you want to enter a calendar date. When selected, text fields of "DST start date", "DST start time", "DST stop date", and "DST stop time" are available.</p> <p><b>Use month and day of week:</b> If you want to select a day of the week, i.e., Sunday. When selected, drop-down menus of "DST start day of week", "DST start day of week last in month", "DST start time", "DST stop day of week", "DST stop day of week last in month", and "DST stop time" are available.</p>
DST start month	Select month from drop-down menu. <b>Default:</b> March
DST start date	If "DST fixed by day" is set to "Use month and date", enter calendar in text field. <b>Valid inputs:</b> Positive integers 1-31. <b>Default:</b> 0
DST start time	Enter start time in text field. <b>Valid inputs:</b> Positive integers 0 - 23. <b>Default:</b> 2
DST start day of week	If "DST fixed by day" is set to "Use month and day of week", select the day of the week from the drop-down menu. <b>Default:</b> Sunday
DST start day of week last in month	If "DST fixed by day" is set to "Use month and day of week", select the week of the month from the drop-down menu. <b>Options:</b> First, last, second, second last, third (e.g. Sunday) in month <b>Default:</b> Last in month, i.e., last week in month.
DST stop month	Select month from drop-down menu. <b>Default:</b> October
DST stop date	If "DST fixed by day" is set to "Use month and date", enter calendar day in text field. <b>Valid inputs:</b> Positive integers 1-31. <b>Default:</b> 0
DST stop time	Enter stop time in text field. <b>Valid inputs:</b> Positive integers 0 - 23. <b>Default:</b> 2
DST stop day of week	If "DST fixed by day" is set to "Use month and day of week", select the day of the week from the drop-down menu. <b>Default:</b> Sunday
DST stop day of week last in month	If "DST fixed by day" is set to "Use month and day of week", select the week of the month from the drop-down menu. <b>Options:</b> First, last, second, second last, third (e.g. Sunday) in month <b>Default:</b> Last in month, i.e., last week in month.

## Country

Setting	Description
Select country	The country setting controls the inband tones used by the base station (dial tone, ringing tone (colloquially called ringback tone, Freiton), busy, call waiting, redial tones). Select a country from the drop-down menu.
State/region	This drop-down menu is available when the selected country has more than one timezone. Select a state or region from the drop-down menu.
Select language	The language used on the web interface of the base station can be set independently from the country setting. Select a language from the drop-down menu. <b>Default:</b> Language setting of specified country
Set timezone by country/region	When checked, the timezone of the country/region selected on this page will be used. When unchecked, the timezone can be selected manually from the drop-down menu on the <b>Time</b> page. <b>Note:</b> Ticking and unticking the checkbox for <b>Set timezone by country/region</b> will result in checking and unchecking the settings on this page as well as on the <b>Time</b> page. <b>Default:</b> Checked.
Set DST by country/region	When checked, the DST of the selected country/region will be used. <b>Note:</b> Ticking and unticking the checkbox for <b>Set DST by country/region</b> will result in checking and unchecking the settings on this page as well as on the <b>Time</b> page. <b>Default:</b> Checked.
Notes	When counties etc. are using different time settings than the timezone they are located in, the exception will be described in this text field. Applicable to some locations in US and Brazil.



## Security

On this page, trusted and SIP client certificates can be downloaded onto and deleted from the base station. You can also select whether to use the embedded secure web server (HTTPS) and change the password required for logging onto the web interface.

**Note:** SIP and RTP security are server-dependent.

## Certificates

Setting	Description
Idx	Index number. <b>Default:</b> Fixed indexes.
Issued to	IP address or organization/company. This is part of the certificate file. <b>Default:</b> Empty
Issued to	Organization/company/section/branch. This is part of the certificate file. <b>Default:</b> Empty
Valid until	Date Time Year. This is also part of the certificate file. <b>Default:</b> Empty
Use only trusted certificates	Select "enabled" from the drop-down menu to allow use of trusted certificates only. <b>Default:</b> Disabled.

### Importing trusted certificates

The supported format is DER-encoded binary X.509 (.cer).

1. Click on **Browse** and select the file from your PC or server. The name of the selected file is shown to the right of the Browse button.
2. Click on **Load**. The certificate is added to the list of certificates.

### SIP client certificates

Setting	Description
Idx	Index number. <b>Default:</b> Fixed indexes.
Issued to	IP address or organization/company. This is part of the certificate file. <b>Default:</b> Empty
Issued to	Organization/company/section/branch. This is part of the certificate file. <b>Default:</b> Empty
Valid until	Date Time Year. This is also part of the certificate file. <b>Default:</b> Empty

### Importing SIP client certificate and key pair

The supported format is DER-encoded binary X.509 file (.cer), and the key must be provided as an unencrypted PKCS#8 binary file (.key).

**Note:** Client certificate and key pair must be loaded at the same time.

1. Click on **Browse** and select both files from your PC or server.

Name	Date Modified	Size	Kind
certificate-key-DER-PKCS8.key	Today 19:28	634 bytes	Key
certificate-DER.cer	Today 19:23	1 KB	certif

The names of the selected files are shown to the right of the **Browse** button.

**SIP Client Certificates:**

Idx	Issued To	Issued To	Valid Until
<input type="checkbox"/> 0			
<input type="checkbox"/> 1			

[Check All /Uncheck All](#)

With selected: [Delete Certificate\(s\)](#)

**Import SIP Client Certificate and Key Pair:**

Filename:  2 files

2. Click on **Load**. Certificate and key pair are added to the list of certificates.

**SIP Client Certificates:**

Idx	Issued To	Issued To	Valid Until
<input type="checkbox"/> 0	snomcert	Milan	13/12 18:1:6 2025
<input type="checkbox"/> 1			

## Password

Setting	Description
Username	Any supported character, up to 15. <b>Default:</b> admin
Current password	Any supported character. <b>Default:</b> admin
New password	Any supported character, up to 15. <b>Default:</b> Empty
Confirm password	Repeating new password to avoid typing errors
Supporter valid characters: 0-9, a-z, A-Z, @/ <>-_.:!*+##	

## Secure web server

Setting	Description
HTTPS	Select the embedded secure HTTPS server from the drop-down menu and click on <b>Save</b> . <b>Default:</b> Disabled

## Central Directory

The central directory is accessible from all handsets registered at the same base station or in the same multicell installation. The central directory can be a phone list downloaded to the base station or an external source like the company LDAP register.

**Note:** You can use only one or the other, not both simultaneously.

See "Local Phone Directory" on page 42 for information on how to prepare files and how to download them onto the base station. See "LDAP" on page 46 for an LDAP example.

Setting	Description
Location	Select <b>Local</b> or <b>LDAP Server</b> from the drop-down menu. <b>Default:</b> Local
If setting is <b>Central Directory</b> (local setting selected):	
Location	Setting <b>Local</b> is selected.
<b>Note:</b> The parameters <i>Server</i> , <i>Filename</i> , and <i>Phonebook reload interval</i> are used only if the directory file is located on a server. Enter the data and click on <b>Save</b> .	
Server	Enter the IP address and path to the file of the phone list to be downloaded. <b>Default:</b> Empty
Filename	Enter the file name of the phone list to be downloaded. <b>Default:</b> Empty
Phonebook reload interval (s)	Enter the reload interval in seconds. To avoid overloading the base station, we recommend to set longer intervals or to turn off automatic reloading. <b>Default:</b> 0 (phone list will not be reloaded automatically)
If setting is <b>LDAP Central Directory</b> :	
Central directory location	Setting <b>LDAP server</b> is selected.
Server	IP address or URL of the LDAP server
Port	Server port for LDAP
Sbase	This setting specifies the LDAP search base (the distinguished name of the search base object) which corresponds to the location in the directory from which the LDAP search is requested to begin. The criteria depend on the configuration of the LDAP server.
LDAP filter	LDAP name filter is the search criteria for name look-ups. The format of the search filter is compliant to the standard string representations of LDAP search filters (RFC 2254). <b>Default:</b> Empty.
Bind	Specifies the bind "username" for LDAP servers when the handset connects to the server. If the server allows anonymous binds, you can leave the setting blank.
Password	Specifies the bind "password" for LDAP servers. If the server allows anonymous binds, you can leave the setting blank.
Virtual Lists	If your LDAP server does not support server-side result pagination and sorting (VLV extension), select "disabled" from the drop-down list. <b>Default:</b> Enabled.
Handset identity settings	
Name	Select <b>cn</b> or <b>sn+given name</b> from drop-down menu. <b>Default:</b> cn

<b>Setting</b>	<b>Description</b>
Work	Enter an LDAP number attribute <b>Preset:</b> telephoneNumber
Home	Enter an LDAP number attribute <b>Preset:</b> homephone
Mobile	Enter an LDAP number attribute <b>Preset:</b> mobile

## Multicell

Please note that all base stations in a multicell setup must have the same firmware. We recommend that you update all base stations to the latest firmware and reset them before beginning the multicell installation.

- Reset secondary base stations to defaults, and, after the reset, change their **DHCP Options** "Plug-n-Play" setting on the **Network** page to "Disabled".
- Use only the designated primary (master) base station to enter all data, i.e., set up the SIP server(s), creating extensions/user accounts, register handsets, etc.
- **Note:** Entering a time server on the **Time** settings page of the primary base station's web interface is mandatory for multicell installations!

Setting	Description
<b>Settings for this unit</b>	
Multicell system	Select "Enabled" or "Disabled" from the drop-down list. <b>Default:</b> Disabled.
System chain ID	All base stations in a multicell system must have the same system chain ID. <ul style="list-style-type: none"> <li>• <b>Note 1:</b> The chain ID is used as a SIP account, i.e., extension 512, to identify different DECT chains in the same network. This means that you cannot assign extension 512 to handsets or use it for calls. It is possible to assign a different chain ID, but <b>by provisioning only</b> (valid input: up to 5 digits).</li> <li>• <b>Note 2:</b> There can be several multi-cell systems in the network. Up to 24 levels of base station chains are permitted.</li> </ul> <b>Default:</b> 512
Synchronization time (s)	Specifies the period in seconds when base stations in a multicell system synchronize with each other. If no keepalive packets are received within this period, the base station will be treated as unreachable in the multicell system. <b>Default:</b> 60 seconds
Data Sync	Select multicast or peer-to-peer from the drop-down menu. Multicast uses UDP. The multicast port (range 49200-49999) and IP address (range 224.1.0.0-225.1.0.0) are calculated from the chain ID. <b>Default:</b> Multicast
Primary data sync IP	IP address of base station data sync source, i.e., the base station handling the data synchronization. <ul style="list-style-type: none"> <li>• When the data sync setting is multicast, this setting is disabled; the IP is selected automatically.</li> <li>• If data sync setting is peer-to-peer, the source <b>must</b> be defined. The <b>default</b> value is 0.0.0.0.</li> </ul>
Multicell debug	224.1.0.0-225.1.0.0) <ul style="list-style-type: none"> <li>• <b>None:</b> Debug disabled.</li> <li>• <b>Data sync:</b> Writes header information for all packets received and sent, to be used to debug any special issues. <b>Note:</b> This option should only be enabled for short periods of time when debugging is needed, as it generates a lot of syslog signaling.</li> <li>• <b>Auto tree:</b> Writes states and data related to the auto tree configuration.</li> <li>• <b>Both:</b> "Data sync" and "auto tree" are both enabled. <b>Note:</b> This option must only be used for debugging and not enabled on a normal running system.</li> </ul> <b>Default:</b> None

Setting	Description
<b>DECT system settings</b>	
RFPI system	The RFPI of the base station is entered automatically.
Auto configure DECT sync source tree	Allows the multicell system to automatically synchronize the multicell chain/tree. This setting must be enabled to allow a secondary base station to take over the primary base station function if the original base station becomes disabled. <b>Default:</b> Enabled
Allow multi primary	This feature allows two or more primaries in the same system and is used for multilocation setups. The primaries are unsynchronized, and handover is not possible. The setting <b>Auto configure DECT sync source tree</b> must be enabled. <b>Default:</b> Disabled
Auto create multi primary	Available when the setting <b>Allow multi primary</b> is enabled. This setting enables the multicell system to generate a second cell when a base station goes off-line and radio connection between parts of the system is lost. After reconnecting the faulty base station, the system must be rebooted. <b>Default:</b> Disabled
<b>Base station settings</b>	
Number of SIP accounts before distribution load	The maximum number of handsets that are permitted to perform location registration on a specific base station before the load is distributed to other base stations. The parameter can be used to optimize handset distribution among visible base stations. <b>Note:</b> In a multi-cell setup, a maximum of 8 simultaneous calls can be routed through each base station. <b>Permitted input:</b> Positive integers (e.g., 8)
SIP server support for multiple registrations per account	Select option from drop-down menu. <b>Disabled:</b> (For servers that do not support moving SIP registrations from base station to base station when handset roams.) The SIP registration of a handset remains on the original base station when the handset roams to another base station. The handset does not SIP-register on the second base station. <b>Enabled:</b> When a handset roams to another base station, the SIP registration of the handset on the original base station is deregistered, and the handset SIP-registers on the second base station. <b>Default:</b> Disabled
System combination (number of base stations/repeaters per base station)	Three settings are available. <b>Note:</b> The configuration must be set at the time the multicell system is configured. It cannot be modified: <b>50/3:</b> 50 base stations and 3 repeaters <b>127/1:</b> 127 base stations and 1 repeater <b>254/0:</b> 254 base stations and 0 repeater
<b>Base Station Group</b>	
ID	Base station identity in the chained network. Automatically assigned consecutively when new base stations are added to the chain. With checkbox for selection for removal from chain. <b>Permitted output:</b> Positive integers.
RPN	The Radio Fixed Part Number is an 8-bit DECT cell identity allocated by the installer. The allocated RPN within the SME must be geographically unique. <b>Permitted output:</b> 0 to 255 (DEC) or 0x00 to 0xFF (HEX)
Version	Current firmware version on base station. <b>Permitted output:</b> Positive integers with dot (e.g, 355.21).

Setting	Description
MAC address	The media access control (MAC) address is a unique identifier assigned by the manufacturer. Printed on device's label and on <b>Home</b> page of web interface.
IP address	The Internet Protocol address assigned by the network the base station is located in.
IP status	Current base station status in the SME network. <b>This unit:</b> Indicates that you are looking at this base station's web interface. <b>Connected:</b> The base station is online in the network. <b>Connection lost:</b> The connection to the base station has been lost.
DECT sync source	<p>The drop-down menu contains the RPNs of each of the currently connected base stations followed (in parentheses) by the strength of the respective radio signal (RSSI) in dBm, as received by the base station whose web interface you are currently accessing. The maximum number of multicell chain levels is 12.</p> <ul style="list-style-type: none"> <li>When the DECT system setting <b>Auto configure DECT sync source tree</b> is set to "enabled", the sync source tree will be generated automatically.</li> <li>When the setting is "disabled", the sync source tree must be configured manually by selecting each base station's sync source from the drop-down menu.</li> </ul> <p>The visible option shows which sync source each of the base stations in the DECT chain is currently using. If you select a different option, the chain must be rebooted. Options:</p> <p><b>Select as primary:</b> This option is visible when the base station is selected as the primary. Select from the drop-down menu of a secondary base station to make that base station the primary.</p> <p><b>Primary:RPNxx (-xxdBm):</b> This option is visible when the base station is a secondary level base station whose sync source is the primary.  Example: Primary:RPN00 (-72dBm)</p> <p><b>Levelx:RPNxx (-xxdBm):</b> This option is visible when the base station is a secondary level base station whose sync source is another secondary level base station.  Example: Level1:RPN04 (-68dBm)</p> <p><b>(any) RPN:</b> Indicates a base station that is not synchronized to any other base station.</p>
DECT property	<p>Base station characteristics in connection to the current multi cell network.</p> <p><b>Possible output(s):</b></p> <ul style="list-style-type: none"> <li><b>Primary:</b> Primary base station all other nodes in the chain synchronize to.</li> <li><b>Locked:</b> The base station is currently synchronized and locked to the primary.</li> <li><b>Searching:</b> The base station is in the process of locating to a DECT sync source.</li> <li><b>Free Running:</b> A locked base station that suddenly lost synchronization to the primary.</li> <li>Cell empty: No current connection information from base station.</li> <li><b>Assisted lock:</b> Base station has lost DECT sync source, and Ethernet is used for synchronization.</li> <li><b>Sync. Lost:</b> Handset has an active DECT connection with the base station but the base station has lost connection to DECT sync source. The base station will continue to work as long as the call is active, then go into search mode when the call is terminated.</li> </ul>
Base station name	Base station name that was assigned to the base station in the Management settings and that also appears at the top of its web interface, within the base station group, and in the DECT chain of a multicell installation.

<b>Setting</b>	<b>Description</b>
DECT Chain	
Primary or Level 1 - 12	The DECT chain (also called DECT tree) is the graphic depiction of the levels and connections of the synchronized base stations and repeaters listed in the "Base Station Group" table.
Button "Reboot chain"	The reboot will start when there are no calls in the system.
Button "Force reboot chain"	The reboot will start immediately, and ongoing calls will be dropped.
Button "Reconfigure DECT tree"	DECT chain will be reconfigured



## Repeaters

For information on registering repeaters, see "Registering M5 repeaters" on page 37.

Setting	Description
Idx	Index of repeaters. Repeaters are numbered consecutively by the base station. With checkbox for registering them at and deregistering or deleting them from the base station.
RPN	<ul style="list-style-type: none"> <li>Assigned by base station during automatic registration.</li> <li>Selected from drop-down menu during manual registration of daisy-chained repeaters.</li> </ul>
Name/IPEI	The name given to the repeater during the registration process and its IPEI or its IPEI, if no name assigned.
DECT sync source	Assigned by base station during automatic registration. Selected from drop-down menu during manual registration of daisy-chained repeaters.
DECT sync mode	The sync mode selected for the repeater during the registration process. Options: <b>Local automatical:</b> Recommended when registering repeaters directly at the base station or - in a multicell system - directly at the primary or any secondary base station in the chain. <b>Manual:</b> Obligatory when daisy-chaining repeaters to other repeaters.
State	<b>Enabled:</b> Repeater has been registered on the base station. <b>Present@RPNxx:</b> Repeater with DEC source RPNxx (base station or other repeater) is connected to the base station.
FW info	Firmware version
FWU progress	Progress states: <b>Off:</b> No update in progress. <b>Initializing:</b> Update has been initiated. <b>X%:</b> Update in progress, X% completed. <b>VerifyingX%:</b> FWU writing is done, verification X% completed. <b>"Conn. term. wait" (Repeater):</b> Firmware has been updated; repeater will restart when there are no active calls in system. <b>Complete HS/repeater:</b> Update complete. <b>Error:</b> Unable to update (file not found, file not valid, etc.)

## Alarm

For information on configuring alarm settings and selecting them for individual M85 and M65 handsets, see "Emergency alarm" on page 41.

This menu contains the available emergency alarm profiles that can be set for M85 and M65 handsets registered at the base station. Configured profiles are selected for individual handsets on the **Handset** page. For more information, see "Selecting Emergency Alarm Setting on M700" on page 31 and "Selecting Emergency Alarm Setting on M300" on page 35, respectively.

Setting	Description
Idx	Alarm profiles are numbered consecutively by the base station.
Profile alias	Optional: You can assign a name to each configured profile. The name is added in parentheses to the available profiles on the handset page.
Alarm type	Select <b>Alarm Button</b> from the drop-down menu to enable the alarm feature. <b>Default:</b> Disabled.
Alarm signal	The <b>Call</b> setting is <b>mandatory</b> . When the alarm button on the handset is pressed, the handset will call the phone number specified in the handset's Alarm settings. <b>Mandatory default:</b> Call.
<b>Settings applicable to M85 only.</b> The M65 uses the default settings regardless of the setting.	
Stop alarm from handset	Establishes whether or not an alarm can be cancelled from the handset. <b>Default:</b> Enabled.
Trigger delay	The number of seconds from the moment the handset's alarm button is pressed until the handset calls the alarm number or, if a pre-alarm delay is also configured, before the pre-alarm delay is triggered. <b>Default:</b> 0.
Stop pre-alarm from handset	Establishes whether or not a pre-alarm can be cancelled from the handset. <b>Default:</b> Enabled.
Pre-alarm delay	The number of seconds from the moment the handset's alarm button is pressed until the handset calls the alarm number. The display will show the "Pre-alarm triggered" message, and the emergency ringer, if set, will be played. <b>Default:</b> 0.
Howling	<b>M85 only:</b> Establishes whether or not the handset will emit a howl while it is dialing the emergency number. <b>Default:</b> Enabled.

## Statistics

The **Statistics** page has four subpages: System, Calls, Repeater, DECT. The visible default page is System, as indicated by the larger font (Fig. 1). Click on one of the other links to bring that page on-screen (Fig. 2). Click on the **Export** button top all statistical data to a comma-separated file (.csv); click on **Clear** to clear all statistical data.

### Statistics

**System** / [Calls](#) / [Repeater](#) / [DECT](#)

Fig. 1

### Statistics

[System](#) / **Calls** / [Repeater](#) / [DECT](#)

Fig. 2

Setting	Description
<b>System</b>	
Base station name	IP address and - if set - name assigned to base station in <b>Management</b> settings
Operation/duration	<b>Operation:</b> Time since last reboot <b>Duration:</b> Time since last reset of statistics or firmware upgrade
Busy	The number of times the base station has been busy
Busy duration	The total time the base station has been busy for speech (8 or more calls active)
SIP failed	The number of times SIP registrations have failed
Handset removed	The number of times handsets have been marked as removed
Searching	The number of times the base station has searched for its sync source
Free Running	The number of times the base station has been free-running
DECT source changed	The number of times the base station has changed its sync source
<b>Calls</b>	
Base station name	IP address and - if set - name assigned to base station in <b>Management</b> settings
Operation duration	<b>Operation:</b> Time since last reboot <b>Duration:</b> Time since data was last cleared or since last firmware upgrade
Count	Number of calls on base station
Dropped	Number of active calls that were dropped for reasons like handset moving out of range etc. An entry is stored in the syslog.
No response	Number of active calls that weren't answered, for example because handset was out of range etc. An entry is stored in the syslog.
Duration	The total time that calls were active on the base station.
Active	The total number of active calls on the base station (DECT and non-DECT calls). There can be up to 30 active calls on one base station.
Max active	The maximum number of calls that have been active at the same time.
Codec	Logging and count of codecs used on each call.
Handover success	The number of successful handovers
Handover failed	The number of failed handovers
Audio not detected	Number of incidents

Setting	Description
<b>Repeater</b>	
Idx/name	Idx and - if set - name assigned to repeater in <b>Repeaters</b> settings
Operation	Total operation time since last reboot or reset.
Busy	The number of times the repeater was busy.
Busy duration	The total time that the repeater was been busy for speech (5 or more calls active).
Max active	The maximum number of calls that have been active at the same time.
Searching	The number of times the repeater has searched for its sync source.
Recovery	When the repeater has lost its sync source, it will attempt to lock onto another base station or repeater. Statistics show recovery mode.
DECT source changed	The number of times the repeater has changed its sync source.
Wideband	The number of wideband calls on repeaters
Narrowband	The number of narrowband calls on repeaters
<b>DECT</b>	
Slot 0 - 11	12 time slots for transmitting audio
Frequency 0 - 9	

## Configuration

This page shows the current settings of the base station; they can be copied into a file, but not edited. To load a new configuration, click on **Browse** and select the file, then click on **Load**. To export the settings, click on **Export**.

For information on how to provision the configuration, see the "Provisioning Guide M700, M300" at [http://wiki.snom.com/Snom\\_M700/Documentation](http://wiki.snom.com/Snom_M700/Documentation).

## Syslog

This page shows the live feed of system level messages of the current base station. The messages shown here depend on the syslog settings configured on the **Management** page. To dump the log, use the copy-and-paste function of your PC operating system to transfer the contents to a data file. If you are using Windows, press Ctrl+S, select a file location and a file type in the pop-up window, name the file, and click on **Save**.

## SIP Log

This page shows server-related messages that are logged during the operation of the SME system. To dump the log, use the copy-and-paste function of your PC operating system to transfer the contents to a data file. If you are using Windows, press Ctrl+S, select a file location and type in the pop-up window, name the file, and click on **Save**.