



SENNHEISER

SP 30 | SP 30 +

Bluetooth® Speakerphone



User Guide

Contents

Package contents	2
Product overview	3
Overview of the Speakerphone	3
Overview of the BT-D 800 USB dongle	5
Setting up the Speakerphone	6
A: Connecting via USB cable	6
Overview: Pairing the Speakerphone with wireless Bluetooth® devices	7
B: Pairing the Speakerphone and a mobile device via NFC™	8
C: Pairing the Speakerphone and a mobile device via Bluetooth®	9
D: Connecting the Bluetooth® dongle to a computer and pairing the Speakerphone	10
Installing Sennheiser software	11
Using the Speakerphone	12
Turning the Speakerphone on/off	12
Connecting Bluetooth® devices	12
Disconnecting Bluetooth® device(s)	13
Clearing the speakerphone's pairing list	13
Clearing the dongle's pairing list	14
Bluetooth® transmission range	14
Adjusting the volume	15
Muting the microphone	15
Making calls using the Speakerphone	16
Making a call	16
Accepting/rejecting/ending a call	16
Redialing	17
Using the voice assistant/ voice dial	17
Managing multiple calls	18
Merging calls – Conference	20
Listening to music using the Speakerphone – Audio playback	21
Additional functions	22
Switching between Bluetooth® personal and shared mode	22
Waking up from standby	22
Retrieving battery status	23
Charging the Speakerphone	24
Enabling/disabling voice prompts	24
Maintaining and updating the products	25
Storing and carrying the Speakerphone	25
Cleaning the products	25
Replacing/removing the Speakerphone's rechargeable battery	26
Updating the firmware of the products	26
If a problem occurs	27
Restoring speakerphone's factory default settings	28
Specifications	29

Package contents

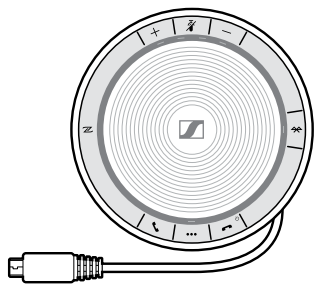

SP 30 Bluetooth® speakerphone with built-in rechargeable battery

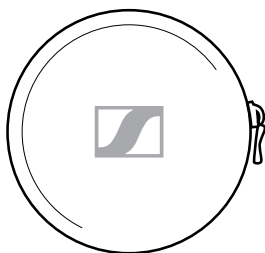

Carry pouch

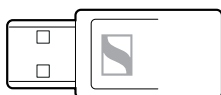

USB-C™ to USB-A adapter

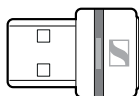

SP 30 + additionally includes:
BTD 800 USB Bluetooth® dongle



Quick Guide
Safety Guide
Compliance sheet



For safety instructions, consult the Safety Guide.

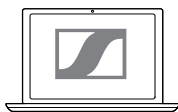

The free Sennheiser software [HeadSetup™ Pro](#) allows you to add value to your Sennheiser products.

i A list of accessories can be found on the product page at www.sennheiser.com/speakerphone.
For information on suppliers, contact your local Sennheiser partner:
www.sennheiser.com/speakerphone > “Find a dealer”.

Product overview

Overview of the Speakerphone

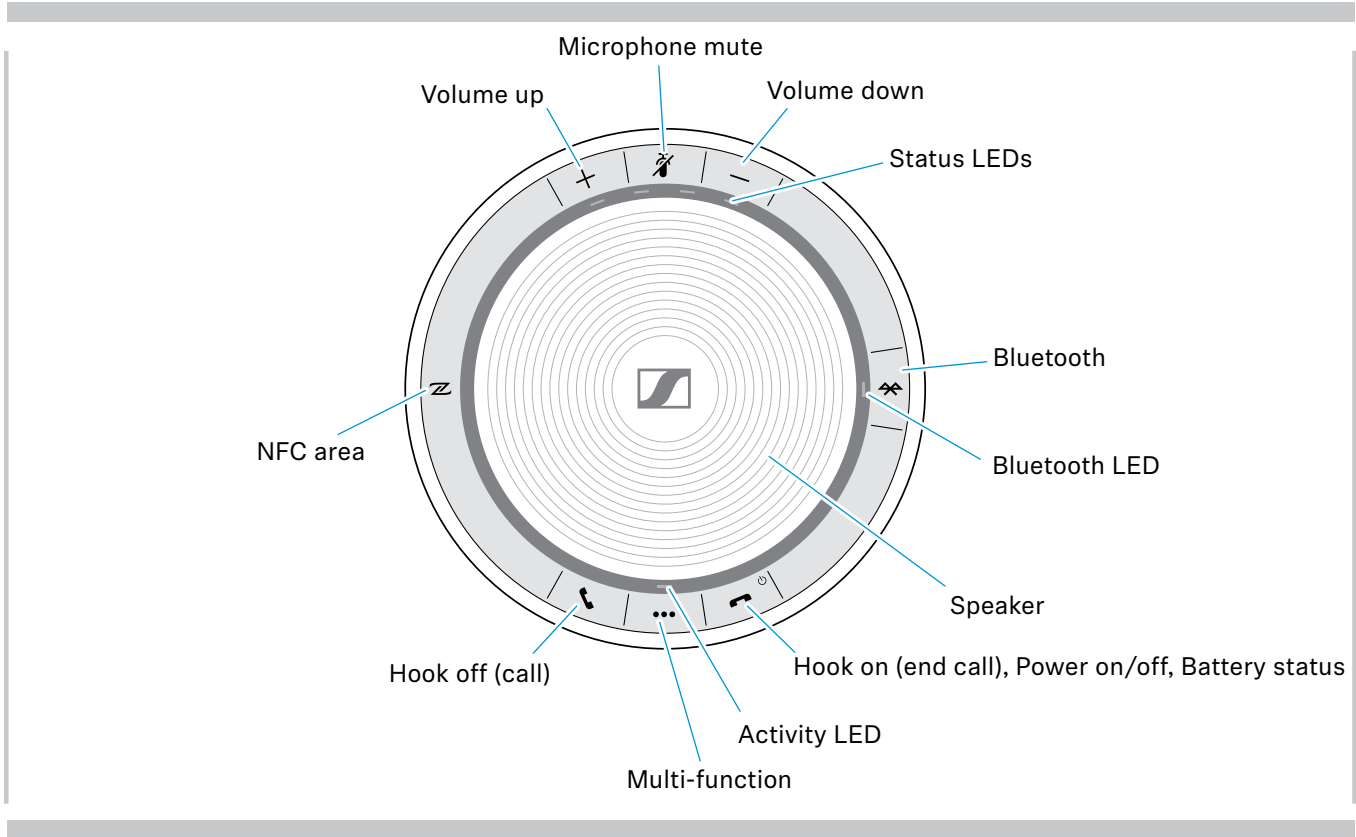

Overview of the bottom

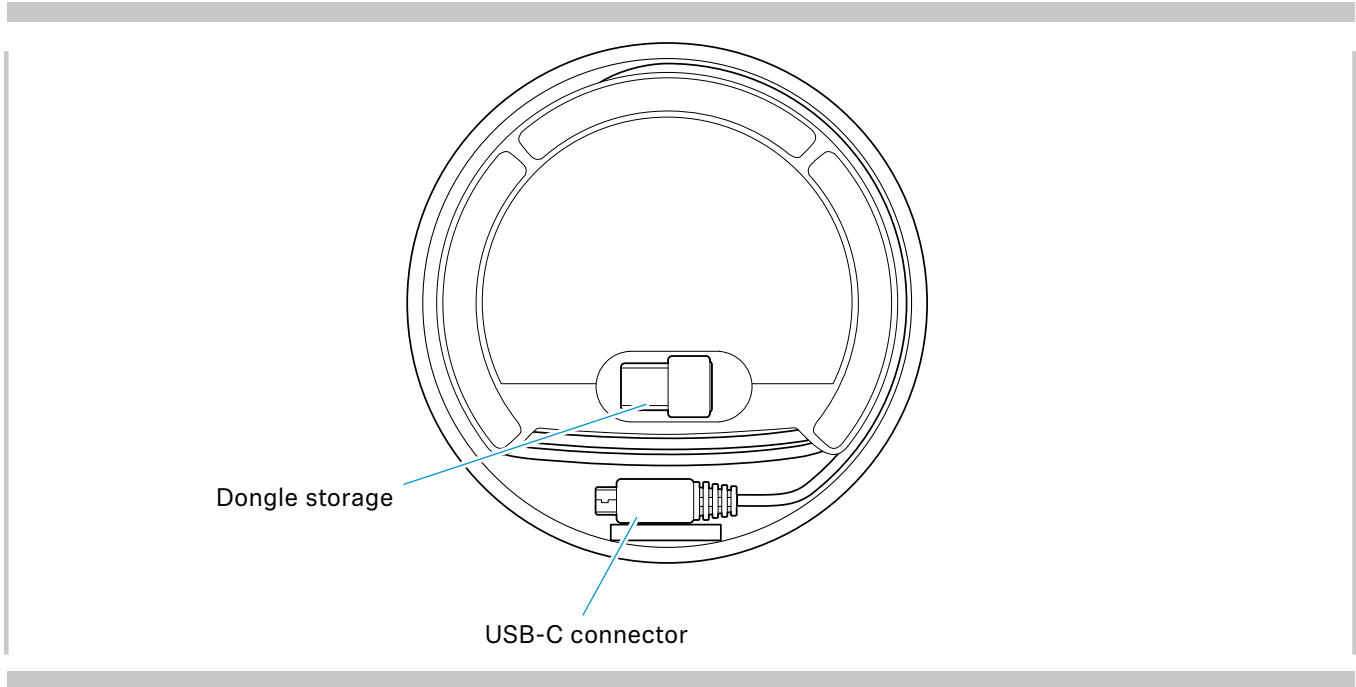

LED overview

Activity LED

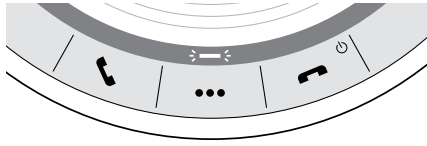

	Meaning
	Speakerphone turned on
3x	Speakerphone turning off
	Speakerphone turned off
	Incoming call
	Active call
	Call on hold
	Second call on hold
	Audio playback

Status LEDs

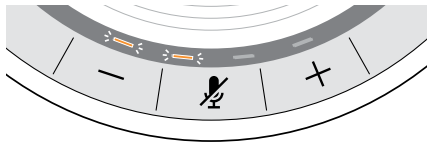

	Meaning
	Microphone muted
	Battery status; eight step indication
	Battery level low
	Volume level; eight step indication

Bluetooth LED

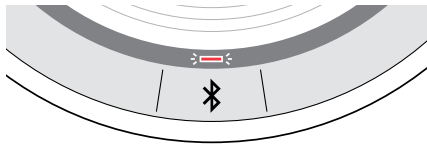

	Meaning
	Speakerphone in pairing mode
	Bluetooth device connected
	No Bluetooth device connected
	Searching for paired Bluetooth devices

Overview of the BTD 800 USB dongle

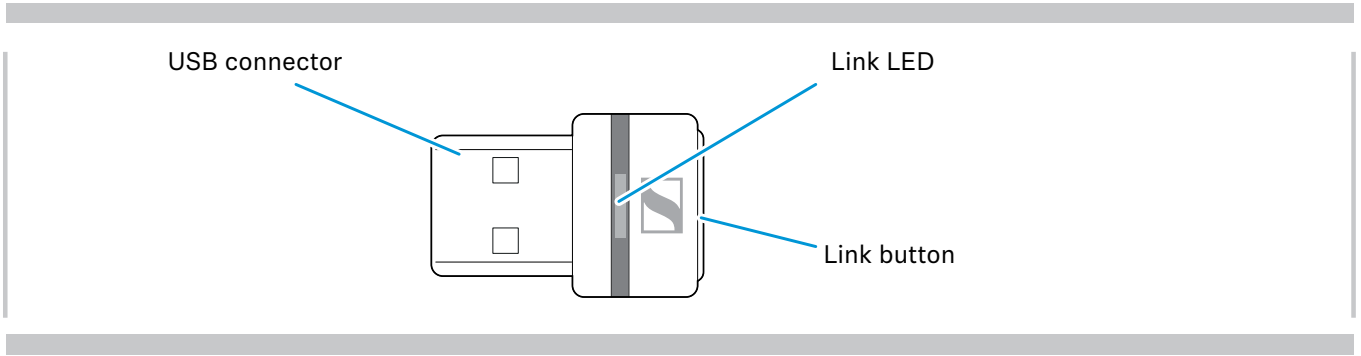

LED overview

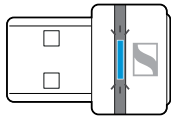

LED	Meaning
↻ — — — — — ↻	Dongle in pairing mode: searching for Bluetooth devices to pair and connect
3x ↻ — — — — — ↻	Pairing successful
3x ↻ — — — — — ↻	Pairing failed
↻ — — — — — ↻	Dongle tries to connect to a Bluetooth device
↻ — — — — — ↻	Dongle and Bluetooth device connected
↻ — — — — — ↻	Incoming call
↻ — — — — — ↻	Outgoing/active call
↻ — — — — — ↻	Audio playback
↻ — — — — — ↻	Microphone of the connected Bluetooth device is muted

Setting up the Speakerphone

The speakerphone can be connected via:

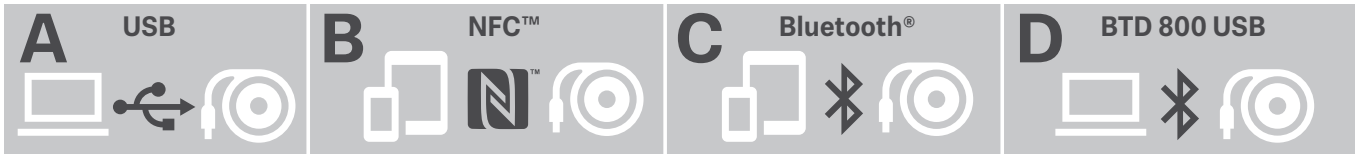

A: USB cable

B: Bluetooth through NFC™

C: Bluetooth®

D: Bluetooth® through Sennheiser dongle (included in SP 30 +)

A: Connecting via USB cable

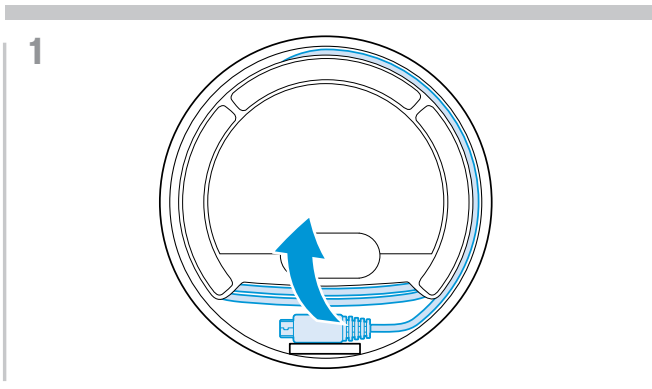

▶ Release the USB plug from the holder and unwind the cable.

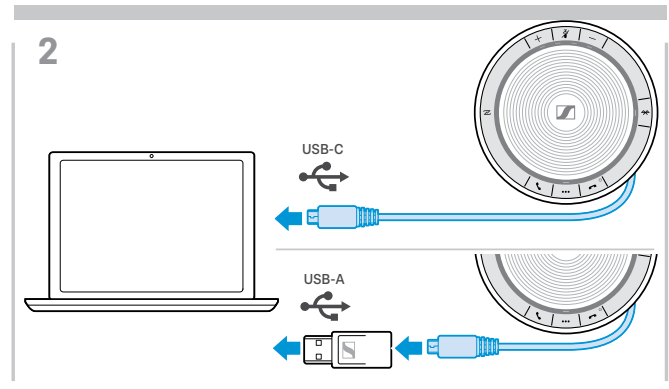

▶ Connect the USB connector directly to a USB-C port or to a USB-A port using the included adapter.

The speakerphone turns on automatically. The LED lights up white.

i The Speakerphone will be charged while connected (device dependent) - see page 24.

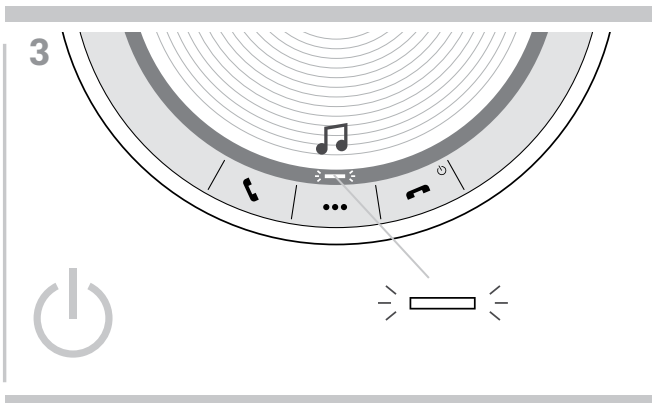

Overview: Pairing the Speakerphone with wireless Bluetooth® devices



CAUTION

Danger of malfunction!

The transmitted radio waves of mobile phones can impair the operation of sensitive and unprotected devices.

▷ Only make calls with the speakerphone in locations where wireless Bluetooth transmission is permitted.

The speakerphone complies with the Bluetooth 5.0 standard. In order to transmit data wirelessly, you have to pair your speakerphone with Bluetooth devices that support “hands free profile” (HFP), “headset profile” (HSP) or “advanced audio distribution profile” (A2DP).

The speakerphone can be paired to:

- a mobile device: via NFC™ (B, see page 8) or via Bluetooth (C, see page 9) or
- the BT-D 800 USB dongle: via Bluetooth (D, see page 10).

The speakerphone can be set to personal or shared mode (see page 22). The default setting is personal mode. In this mode, the list of paired devices is maintained so they reconnect automatically.

Default functionality (personal mode):

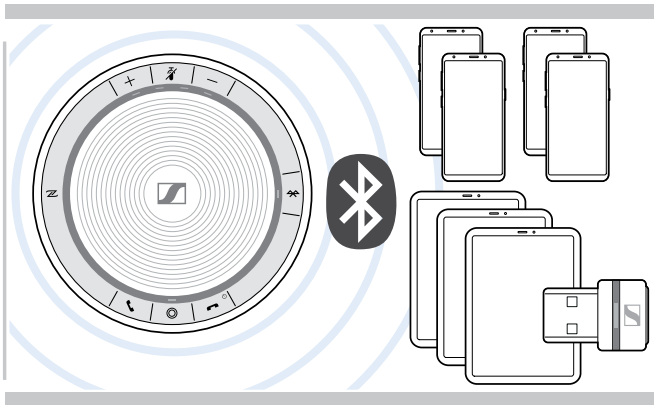

The speakerphone can save up to eight paired Bluetooth devices. If you pair the speakerphone with a ninth Bluetooth device, the saved connection profile of the least recently used device will be overwritten. If you want to re-establish a connection with this device, you have to pair the speakerphone again.

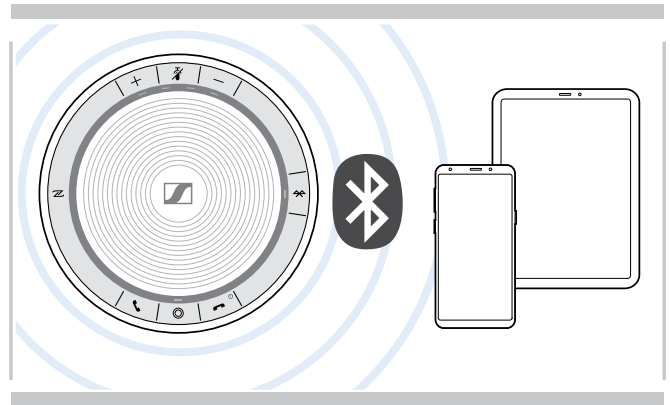

The Speakerphone can be wirelessly connected to two devices at the same time.

You can only connect another device by disconnecting one of the already connected devices.

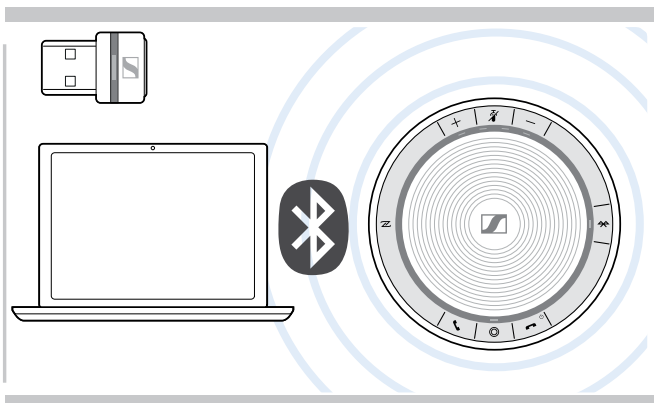

The speakerphone can be used wirelessly with a computer.

You can use:

- the computer's built in Bluetooth functionality or
- the BT-D 800 USB dongle (supplied with SP 30 +).

B: Pairing the Speakerphone and a mobile device via NFC™

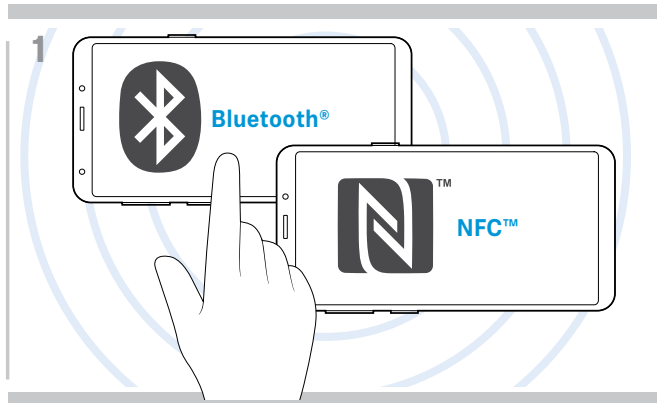

- ▷ Activate Bluetooth and NFC (Near Field Communication) on your mobile device (see instruction manual of your mobile device).

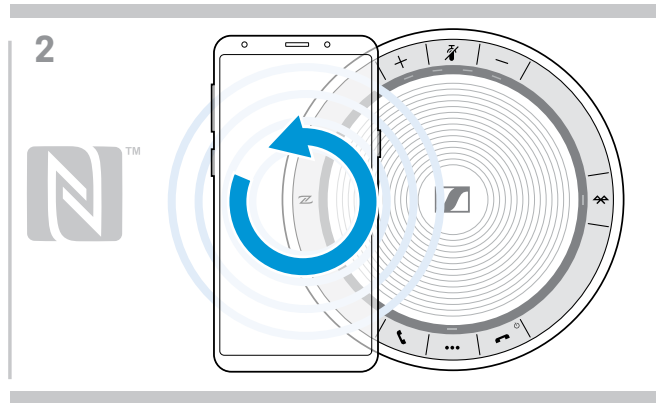

- ▷ Move the mobile device in small circles directly above the NFC area of the speakerphone.
The speakerphone turns on automatically.

Once the speakerphone is paired with the mobile device, the LED lights up blue.

- i** If required: Confirm the speakerphone on your mobile devices.

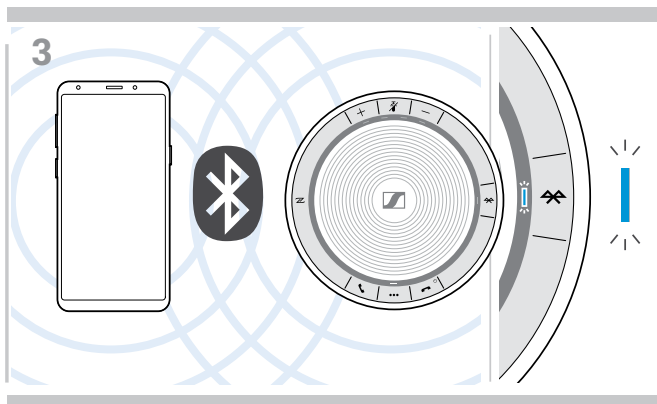

C: Pairing the Speakerphone and a mobile device via Bluetooth®

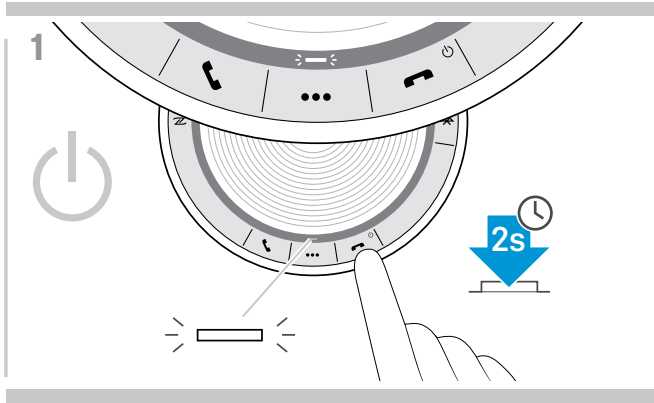

- ▶ Press and hold the Power on/off button to turn on the speakerphone. The LED lights up white.

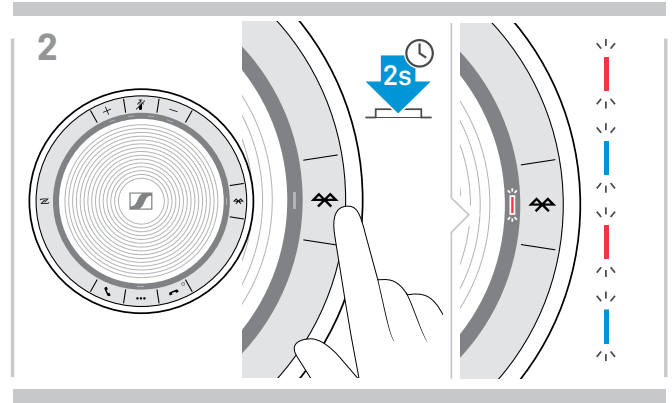

- ▶ Press and hold the Bluetooth button until the LED flashes blue and red. The speakerphone is in pairing mode.

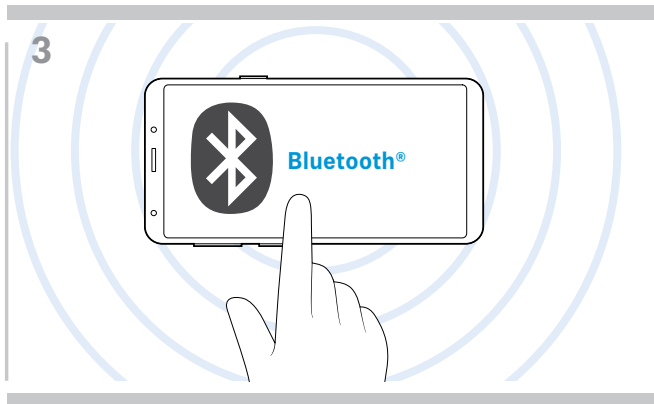

- ▶ Enable the Bluetooth visibility on your mobile device (see instruction manual of your mobile device).

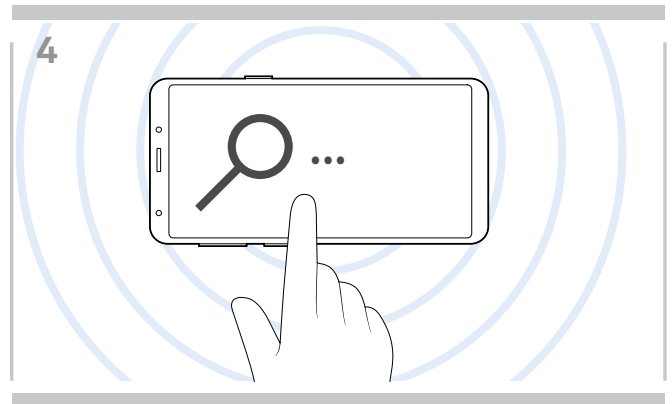

- ▶ Start a search for Bluetooth devices. All available devices in the proximity of the mobile device are displayed.

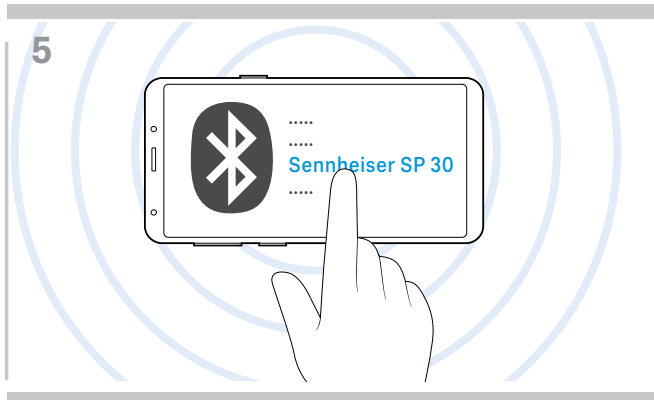

- ▶ Select "Sennheiser SP 30*" to establish a Bluetooth connection to the speakerphone.
* You can change the default name "Sennheiser SP 30" via [HeadSetup™ Pro](#).

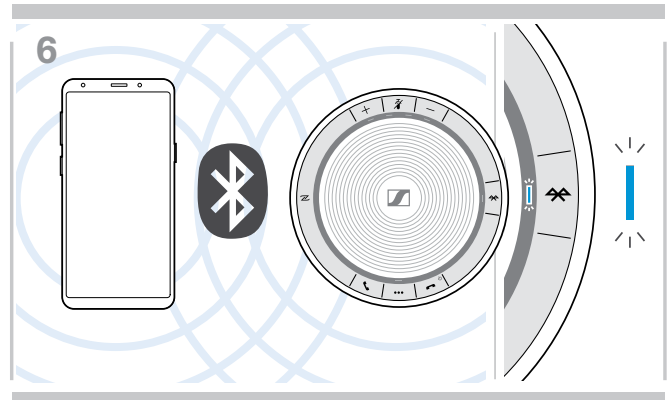

- ▶ Once the speakerphone is paired with the mobile phone, the LED lights up blue.

D: Connecting the Bluetooth® dongle to a computer and pairing the Speakerphone

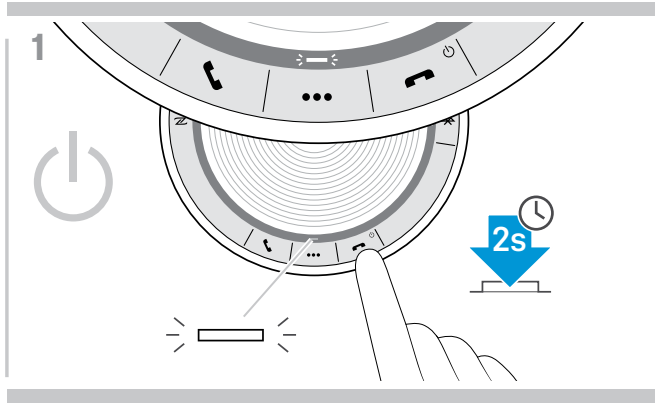

- ▶ Press and hold the Power on/off button to turn on the speakerphone. The LED lights up white.

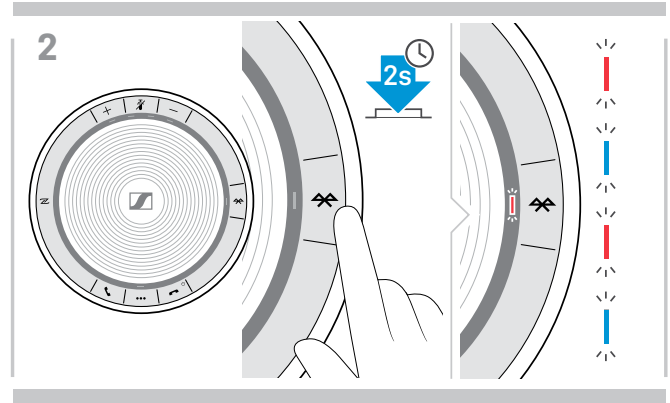

- ▶ Press and hold the Bluetooth button until the LED flashes blue and red. The speakerphone is in pairing mode.

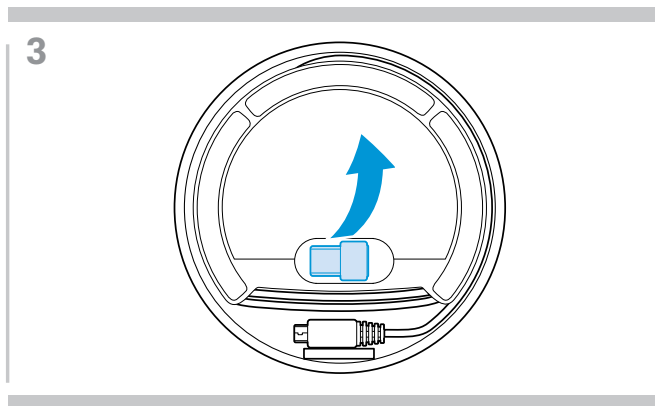

- ▶ Release the dongle from the storage. BT-D 800 USB dongle is supplied with SP 30 +.

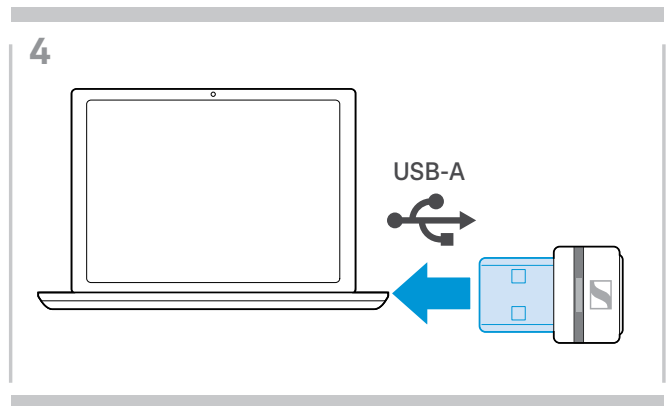

- ▶ Plug the dongle into the USB port of your computer.

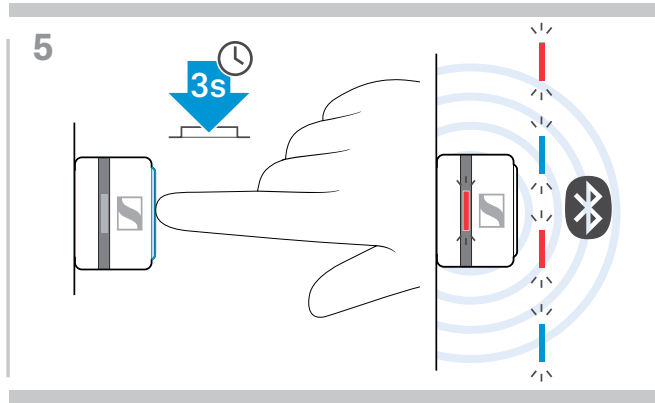

- ▶ Press and hold the dongle's button until the LED flashes blue and red. The dongle is in pairing mode.

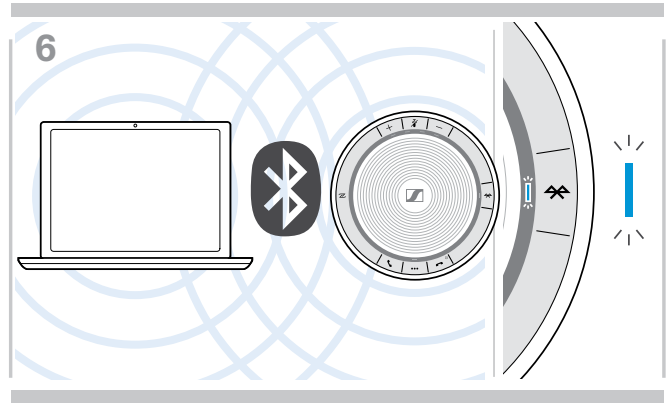

- ▶ Once the speakerphone is paired with the dongle, the LED lights up blue.

Installing Sennheiser software

The free Sennheiser software allows you to add value to your Sennheiser products. It enables easy set-up, configuration and update of your speakerphone.

Examples of supported settings and configurations in **HeadSetup™ Pro**:

- Bluetooth on/off,
- Device name
- Personal/shared mode,
- Manage pairing list
- Sounds and notifications including voice prompt language
- Factory reset

HeadSetup™ Pro offers further configurations and additional settings – see options in the software.

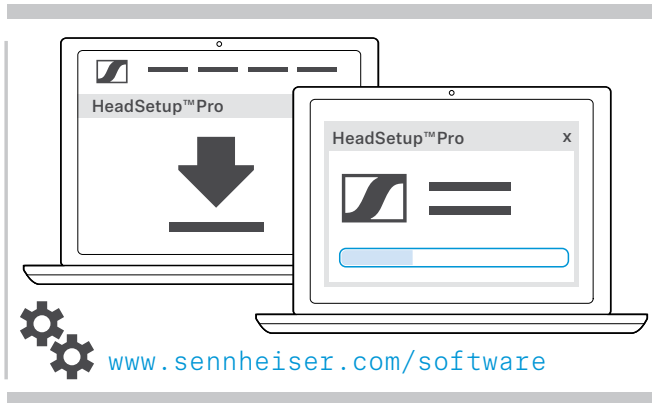

- ▷ Download the software from www.sennheiser.com/software.
- ▷ Install the software.
You need administrator rights on your computer – if necessary, contact your IT department.

To make calls via the computer:

- ▷ Install a softphone (VoIP Software) or ask your admin for support.

Using the Speakerphone

Turning the Speakerphone on/off

Turning the Speakerphone on

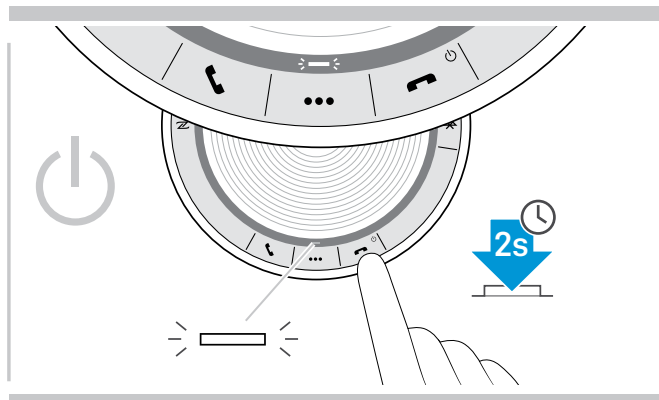

- ▶ Press and hold the Power on/off button. The LED lights up white.

Turning the Speakerphone off

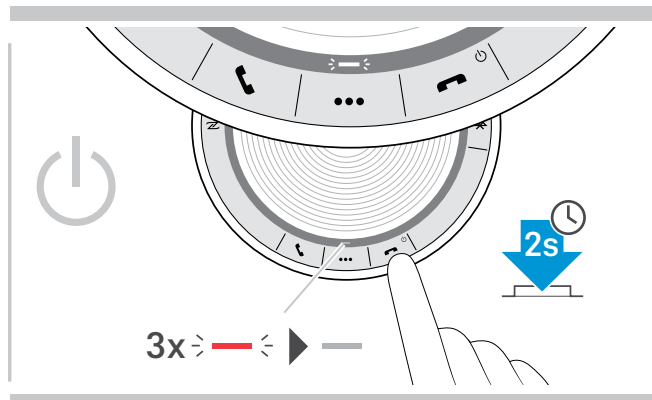

- ▶ Press and hold the Power on/off button. The LED flashes red 3 times and turns off. All volume settings are saved automatically when the speakerphone is turned off.

Connecting Bluetooth® devices

The speakerphone will by default attempt to connect to the two last connected Bluetooth devices. For further information concerning personal/shared mode functionality see page 22.

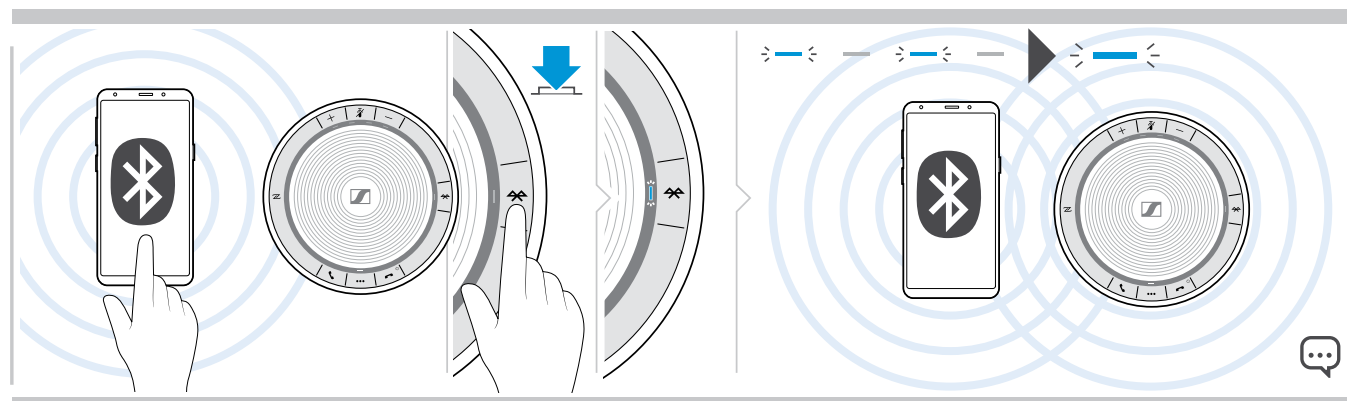

- ▶ Activate Bluetooth on the paired device(s).

If the Bluetooth LED does not flash blue (automatic search after switch-on):

- ▶ Press the Bluetooth button to connect manually.

i Only two out of the maximum eight paired Bluetooth devices can be simultaneously connected to the speakerphone.

i The search for paired devices will timeout if no devices are found. After this, connections must be established manually on the paired Bluetooth device or by pressing the Bluetooth button on the Speakerphone

The LED flashes blue while the speakerphone attempts to connect to previously paired Bluetooth device(s).

Once the connection is successfully established, the LED lights up blue.

Disconnecting Bluetooth® device(s)

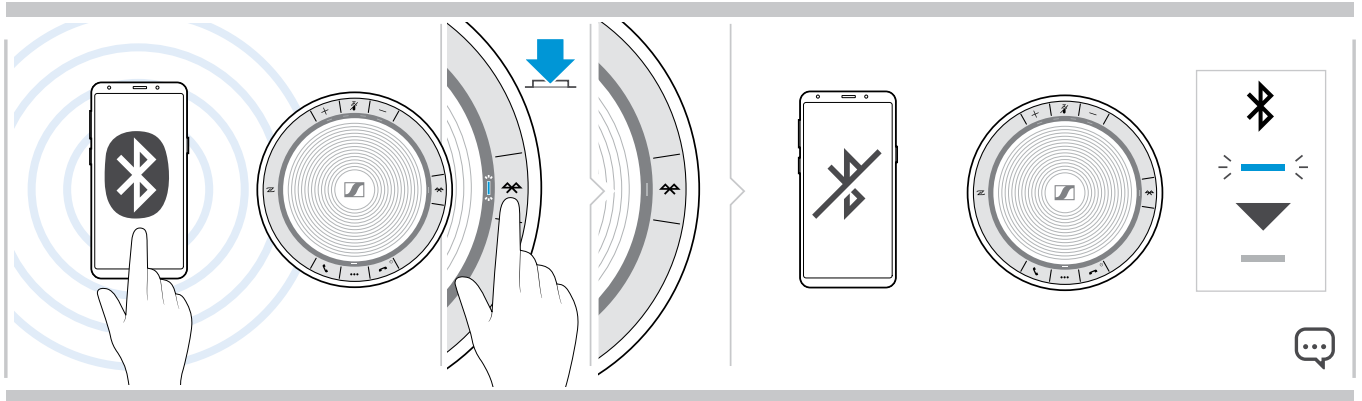

- ▷ Press the Bluetooth button. The LED turns off.
- OR Deactivate Bluetooth on the connected device.

To re-connect paired Bluetooth devices:

- ▷ Press the button again.

Clearing the speakerphone's pairing list

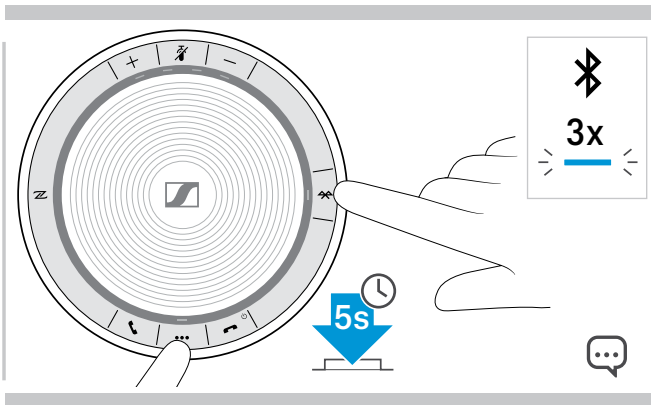

- ▷ Press and hold the multi-function button and Bluetooth button until you hear a voice prompt. The LED flashes blue three times to indicate that pairing list is cleared.

Clearing the dongle's pairing list

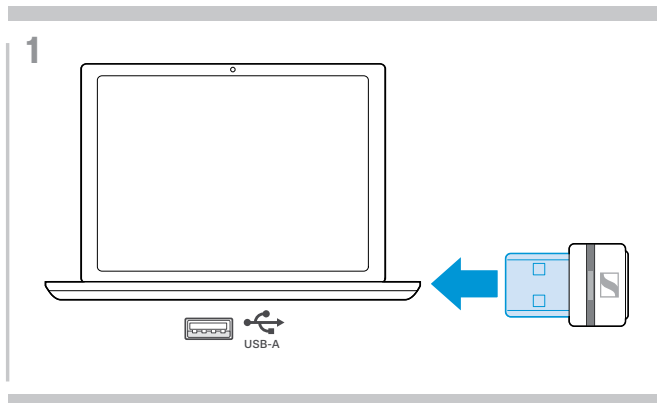

▶ Plug the dongle into the USB port of your computer.

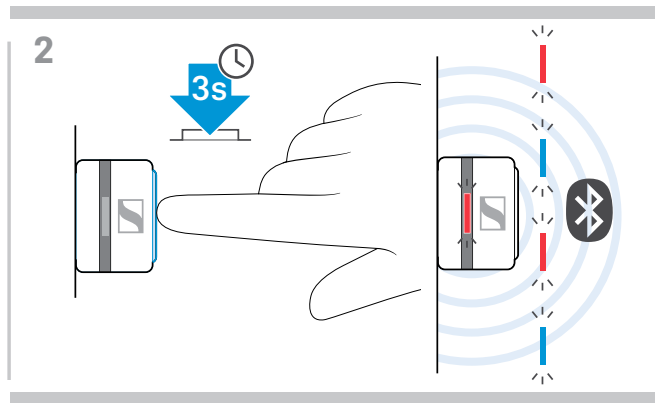

▶ Press and hold the button until the LED flashes blue and red.

▶ Double tap the button.
The LED flashes purple three times to indicate that pairing list is cleared.
The dongle automatically enters pairing mode.

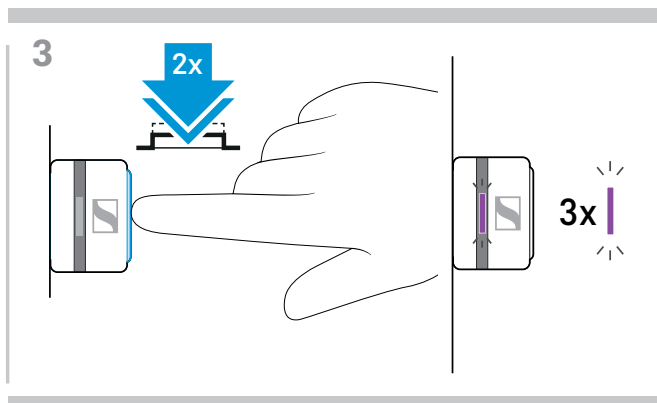

Bluetooth® transmission range

Calling and audio playback is only possible in the Bluetooth transmission range of the devices. The transmission range largely depends on environmental conditions such as wall thickness, wall composition etc. With a free line of sight, the transmission range of most mobile phones and Bluetooth devices is up to 25 meters.

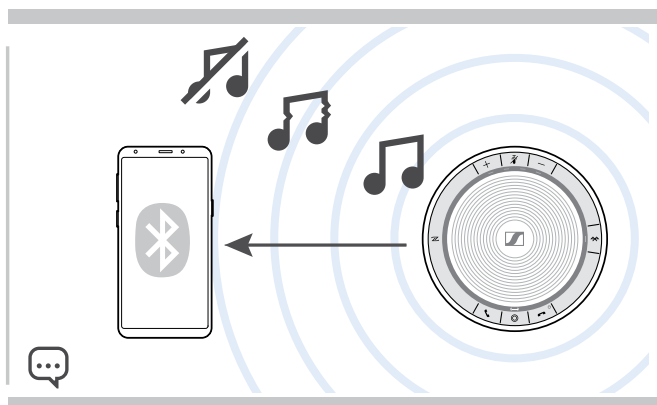

If you leave the Bluetooth transmission range, the audio quality deteriorates first and later connected devices will be disconnected.

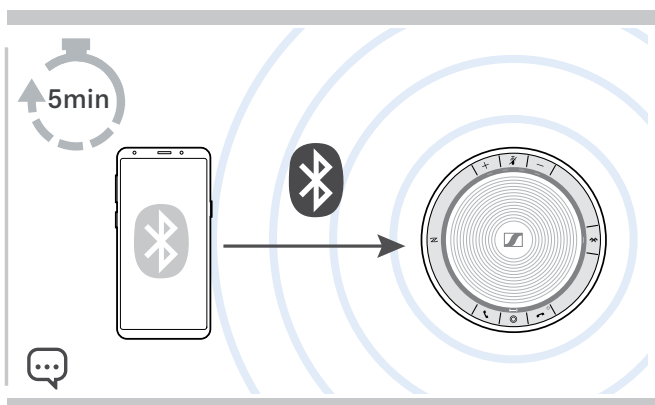

If you re-enter the Bluetooth transmission range **within short period of time**, the speakerphone will attempt to restore the connection(s) – in personal mode only.

If you spend **a longer period of time** outside the Bluetooth transmission range:

▶ Press the Bluetooth button to connect manually.

Adjusting the volume

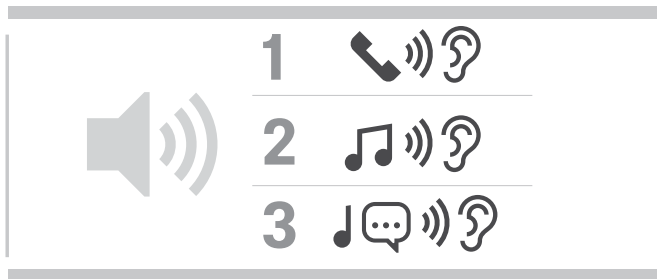

You can adjust three independent volume settings for the speakerphone:

1. Call volume: during an active call
2. Audio volume: during audio streaming
3. Volume for ring tone, tones and voice prompts: in idle mode – no active call or audio streaming

Increasing the volume

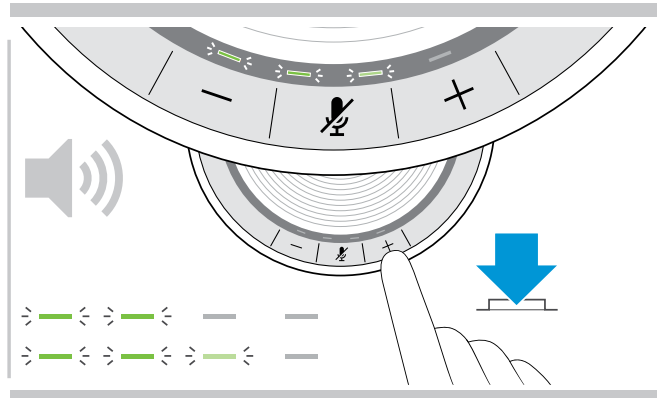

▶ Press the button +
LEDs and volume will be increased or reduced by half step with each button press.

Decreasing the volume

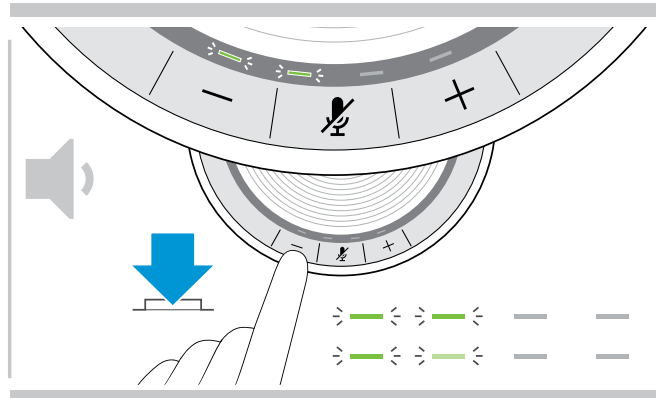

▶ Press the button -

Muting the microphone

Muting the microphone

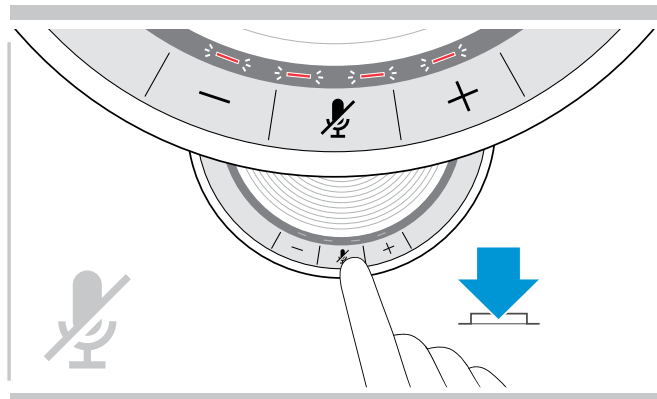

▶ Press the Microphone mute button.
The LEDs light up red.

Unmuting the microphone

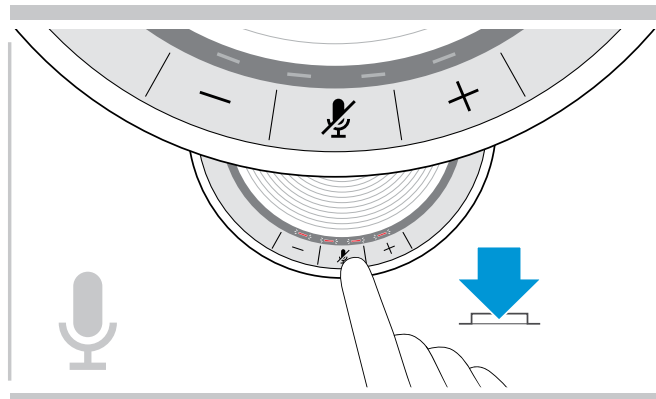

▶ Press the button again.
The LEDs turn off.

Making calls using the Speakerphone

Making a call

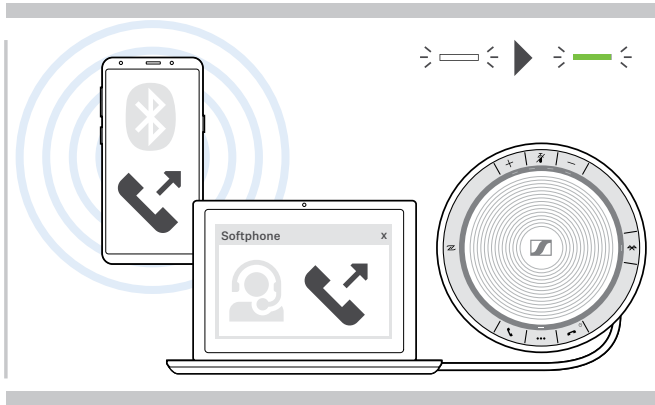

- ▶ Initiate the call on your connected device. The LED lights up green.

If your call is not automatically transferred to the speakerphone:

- ▶ Press the speakerphone's hook off button , or use call transfer functionality on the mobile device.

Accepting/rejecting/ending a call





When you receive a call:

You hear a ring tone and the LED flashes green.

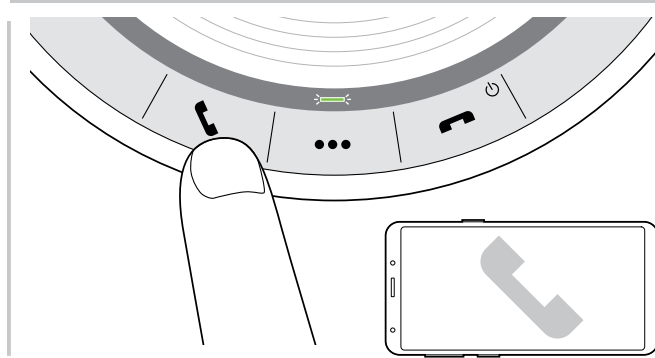

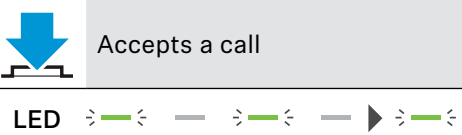
Accept/hold a call



		Accepts a call
		Puts an active call on hold (pause)

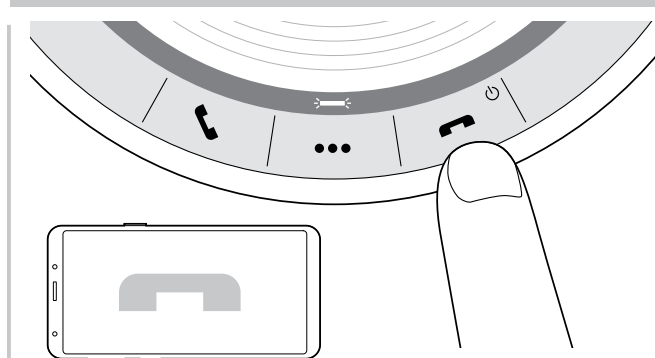

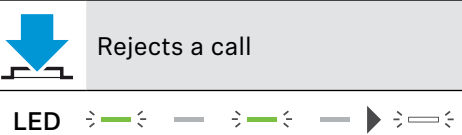

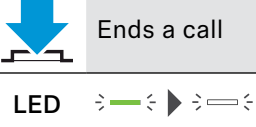

Reject/end a call

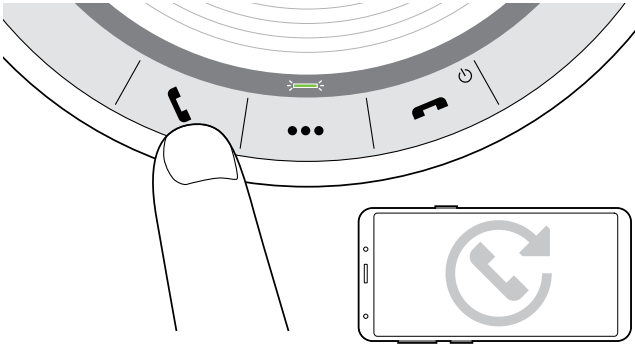

		Rejects a call
		Ends a call

Redialing





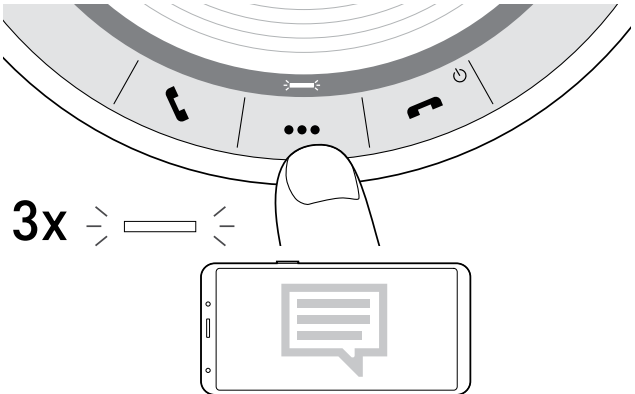

		Redials the last number
	LED	
		Cancels redialing
	LED	

Using the voice assistant/ voice dial

Voice assistant and voice dialing will only be supported for device(s) connected via Bluetooth. Available functionality depends on the connected device.



		Activates voice assistant/ voice dial
		Cancels voice assistant/ voice dial

 The last connected Bluetooth device will be used for voice assistant or voice dial.

Managing multiple calls

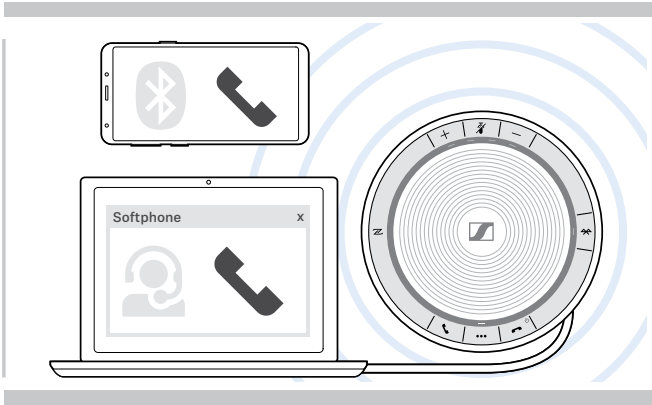

You can use the Speakerphone with up to three connected devices, one connected via USB and two via Bluetooth.

Two calls can be managed simultaneously.

If you receive a call during an active call, a knock on tone will be played.

Accept second call

Active call 2nd incoming call

Accepts the incoming call and puts the active call on hold

LED >—|< —| >—|< —| ▶ >—|< —|< >—|< —|<

Reject second call

Active call 2nd incoming call

Rejects the incoming call and continues the active call

LED >—|< —| >—|< —| ▶ >—|<

Toggle between calls

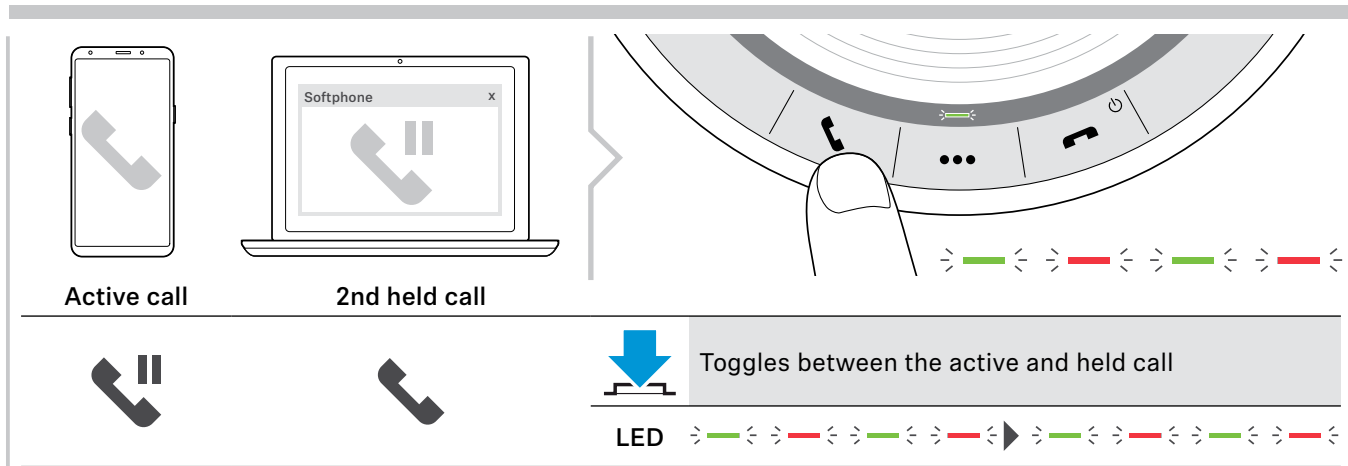

End call

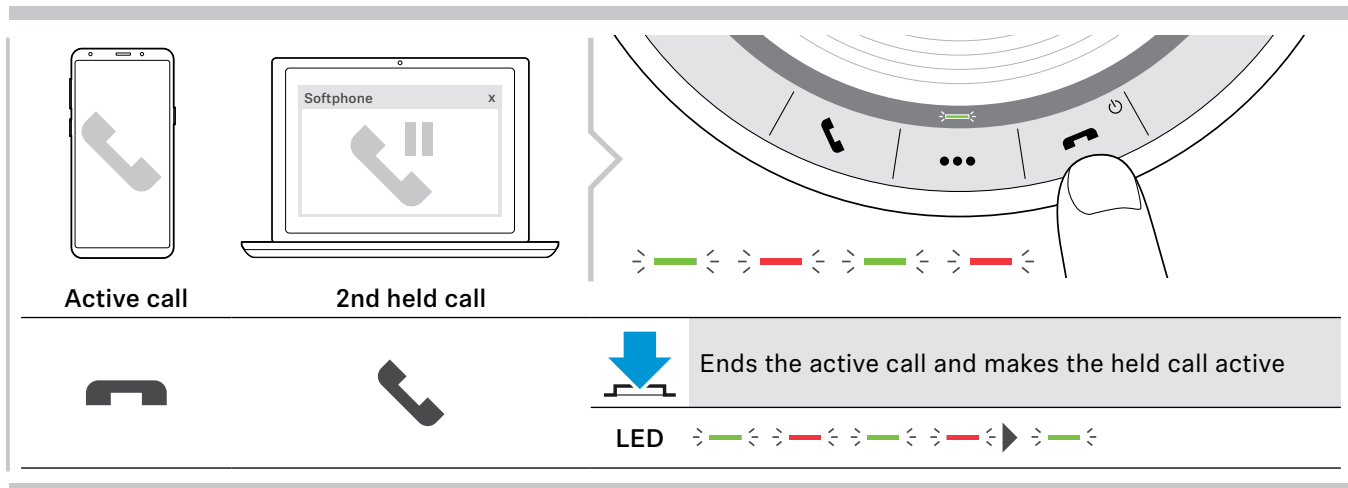

Merging calls – Conference

Two calls – one via USB, the other via Bluetooth – can be merged in a conference.

Merge/unmerge calls

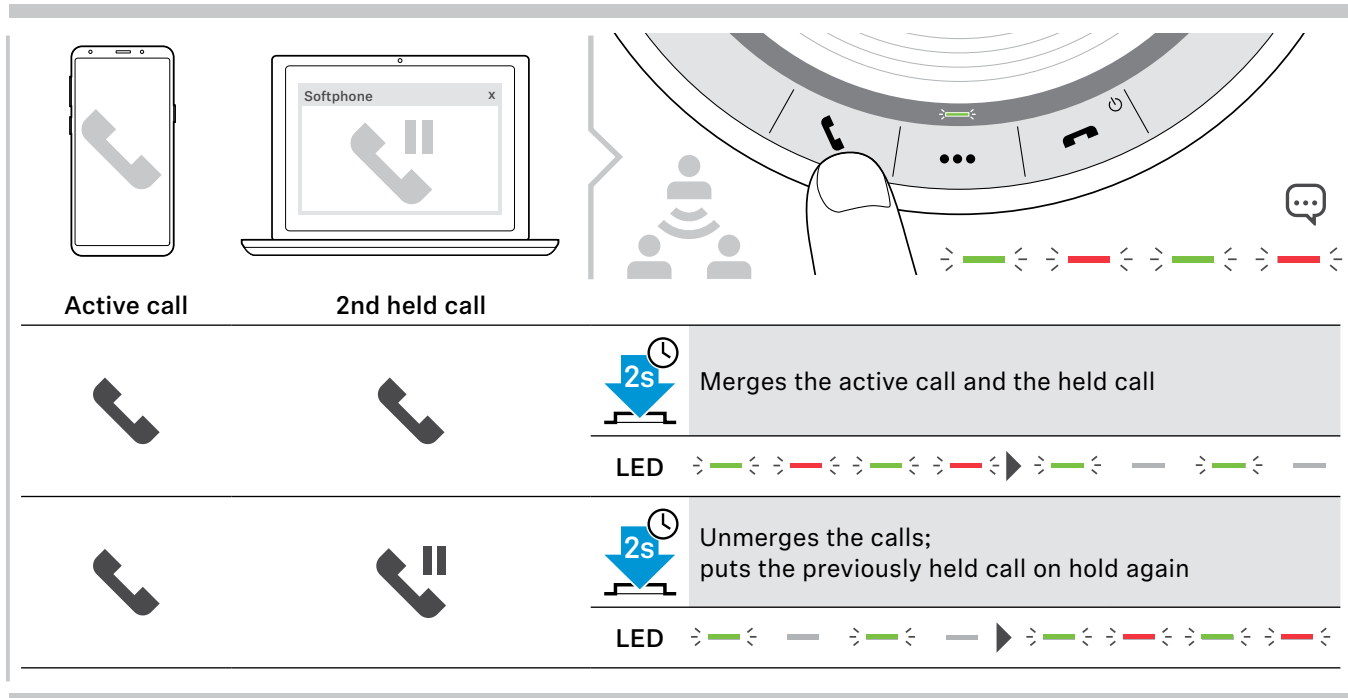

End merged calls

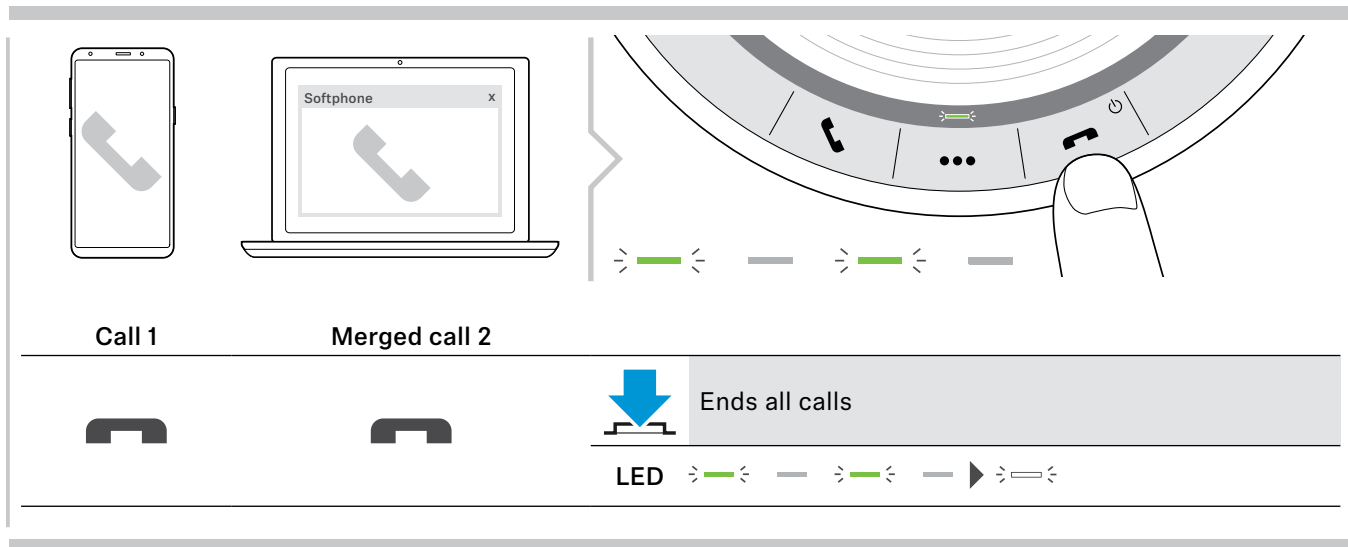

Listening to music using the Speakerphone – Audio playback

You can listen to audio playback via USB or Bluetooth connected device.

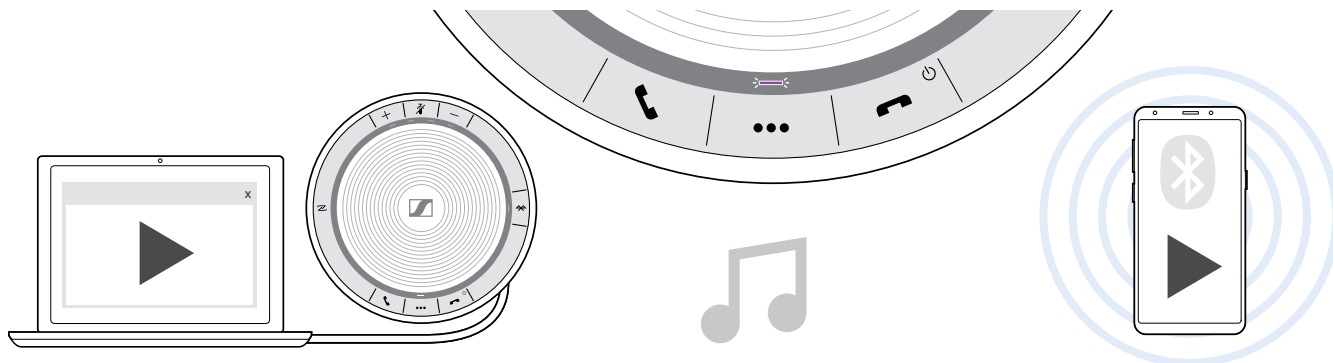

Control active audio playback

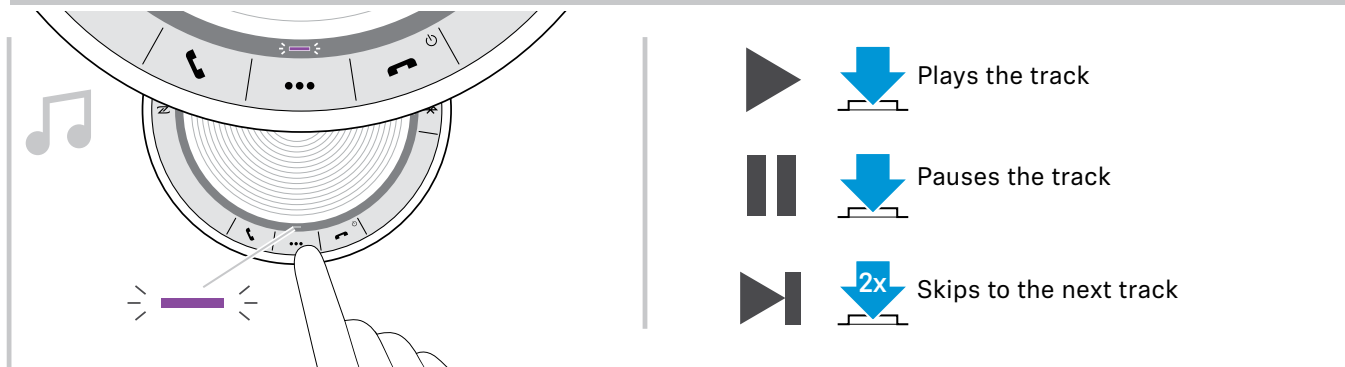

i If you receive and accept a call, audio playback is paused and restarts after the call – if supported by the connected device.

Additional functions

Switching between Bluetooth® personal and shared mode

If the speakerphone is used as a **personal device** it will automatically attempt to connect to the last eight paired devices. In this setup the **Personal Mode** (default) should be used.

If the speakerphone is used as a **shared device** automatic connection to previously paired devices may not be desired. In this setup the **Shared Mode** should be used. In this mode pairing must be performed every time when connecting a device via Bluetooth.

Activating Personal mode

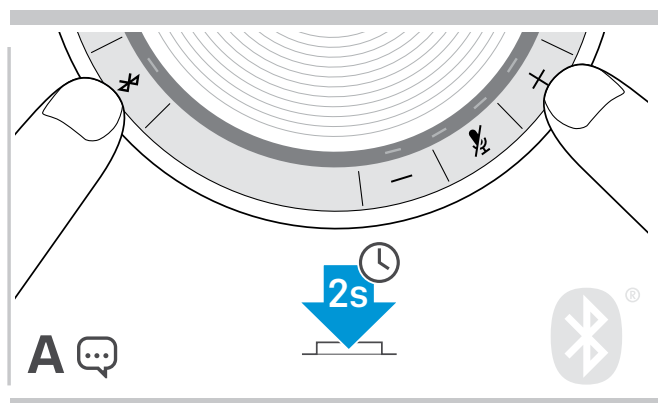

- ▶ Press the Bluetooth and + button.
A voice prompt is announced.

Activating Shared mode

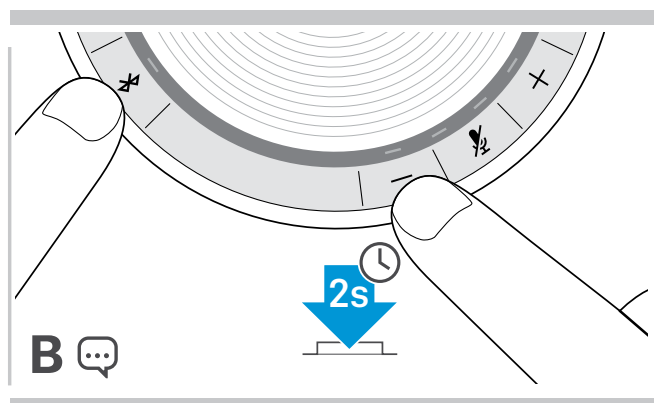

- ▶ Press the Bluetooth and - button.
A voice prompt is announced.

After change of mode, the pairing list is cleared and you have to pair devices again (see page 7).

Waking up from standby

The speakerphone enters standby mode automatically after some time to save energy – depends on connection status, activity etc.

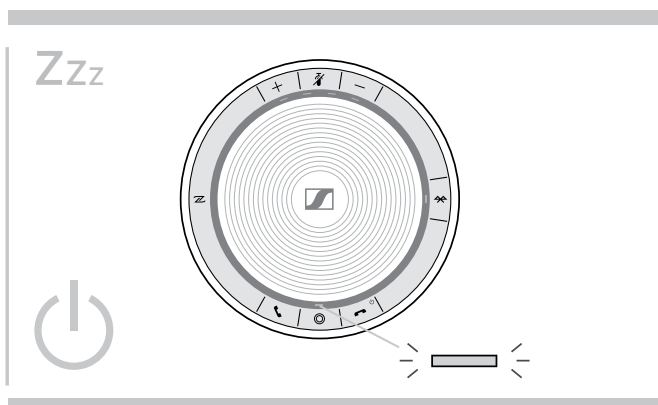

While in standby the activity LED is dimmed and all other LEDs are off.

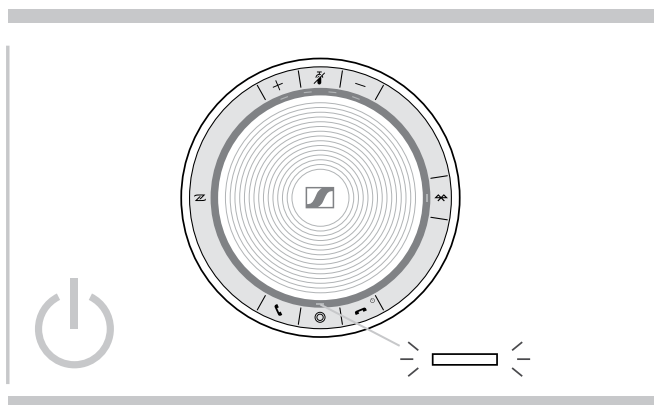

- ▶ Press any button or plug in USB to end the standby mode.

i After a while in standby mode, the speakerphone turns off, if there are no active connections and not connected to a power source.

Retrieving battery status

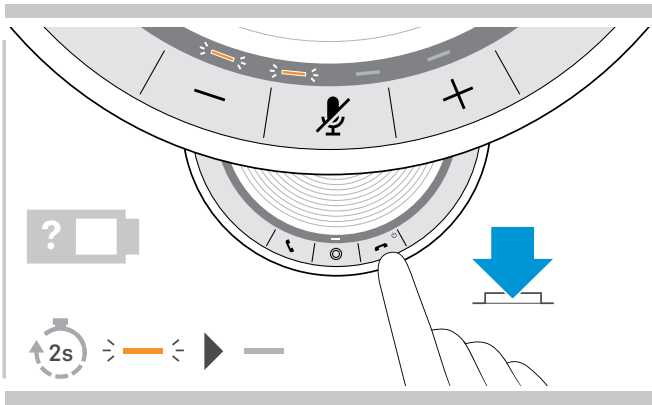

▶ Press the Battery status button.
The LEDs light up shortly.

LED	Battery status
	100%
	between 75% and 100%
	75%
	between 50% and 75%
	50%
	between 25% and 50%
	25%
	between 10% and 25%
	critically low battery: LED flashes red
	▶ Recharge speakerphone (see page 24).

Charging the Speakerphone

When the battery charge level drops below 10%, the LED flashes red. When the battery is empty, the speakerphone turns off automatically.

If you do not use the speakerphone for extended periods of time it is recommended to charge it every 3 months.

You can charge the speakerphone regardless of the power state (on or off).

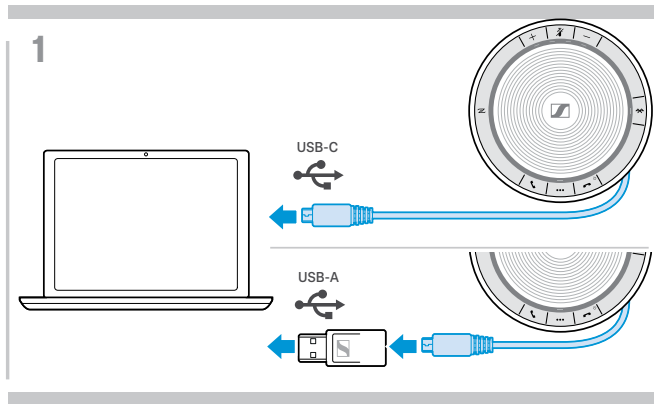

- ▶ Connect the USB connector to a USB-C or USB-A socket of your computer, or to a USB power source. The speakerphone turns on.

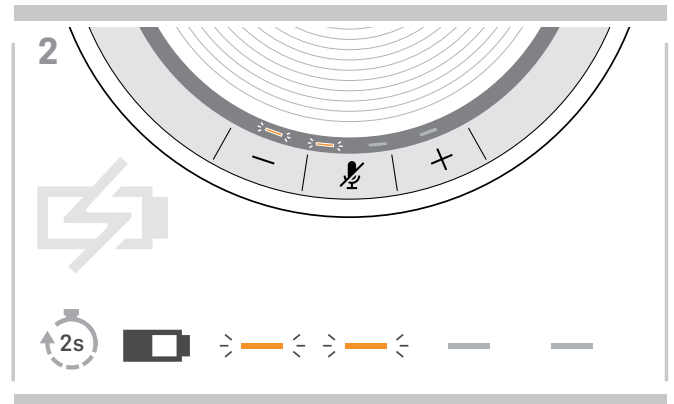

- The battery is being charged. The LEDs shortly light up and show the battery charge level.

Enabling/disabling voice prompts

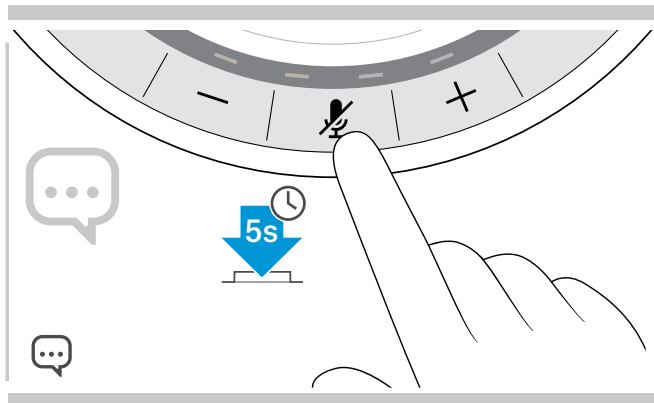

In idle mode (no active call or music reproduction):

- ▶ Press and hold the mute button until the speakerphone announces a voice prompt for on or off.

If the voice prompts are deactivated you hear tones instead.

Maintaining and updating the products

Storing and carrying the Speakerphone

Store the speakerphone in a clean and dry environment. When not in use, store the product in the carry pouch. This will help to avoid scratches and keep the product in good condition.

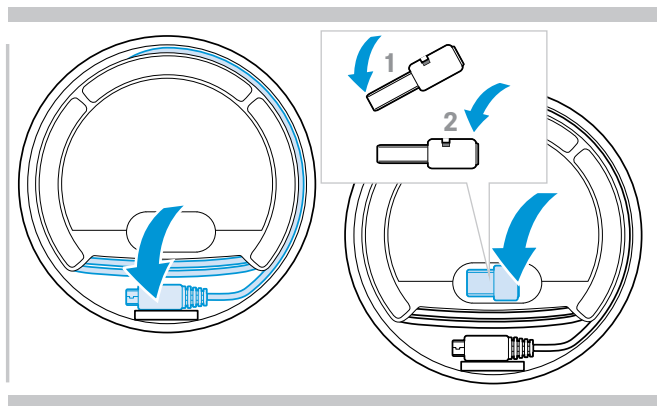

- ▷ Wind up the USB cable.
- ▷ Place the dongle in the storage slot.

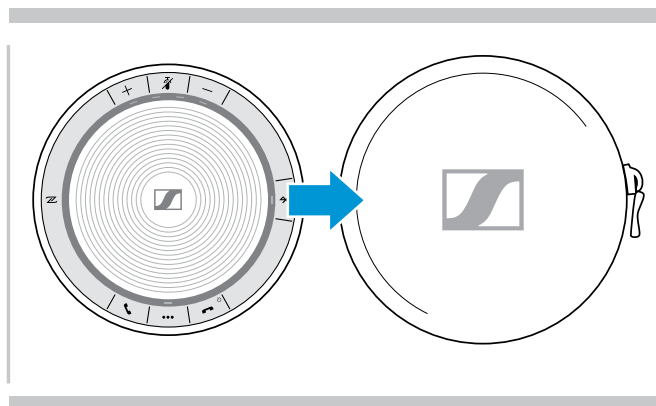

- ▷ Put the speakerphone in the Carry pouch.

Cleaning the products

CAUTION

Liquids can damage the electronics of the product!

Liquids entering the housing of the device can cause a short circuit and damage the electronics.

- ▷ Keep all liquids far away from the product.
- ▷ Do not use any cleansing agents or solvents.

- ▷ Only use a dry cloth to clean the product.

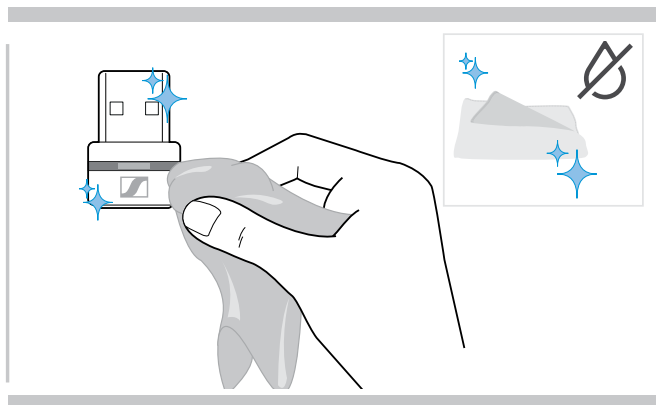
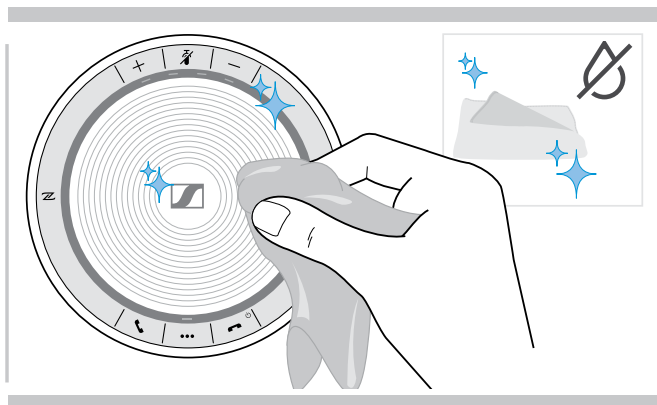

Replacing/removing the Speakerphone's rechargeable battery

CAUTION

Danger of damage to the product!

During the warranty period, the rechargeable battery must only be replaced by an authorized Sennheiser service center, otherwise the warranty will be null and void.

- ▷ Contact your Sennheiser service center if the rechargeable battery needs to be replaced. To find a Sennheiser service partner in your country, visit www.sennheiser.com.

Outside the warranty period, the rechargeable battery may be replaced or removed by any qualified service center or qualified technician of your IT or Service department. Instructions for qualified technicians on how to replace or remove the battery are available from the Sennheiser service partner.

Updating the firmware of the products

You can update the firmware of your speakerphone and dongle by using the free [HeadSetup™ Pro](#) software.

- ▷ Download the software from www.sennheiser.com/software.
- ▷ Install the software.
To install the software, you need administrator rights on your computer. If necessary, contact your IT department.

Updating the firmware of the speakerphone

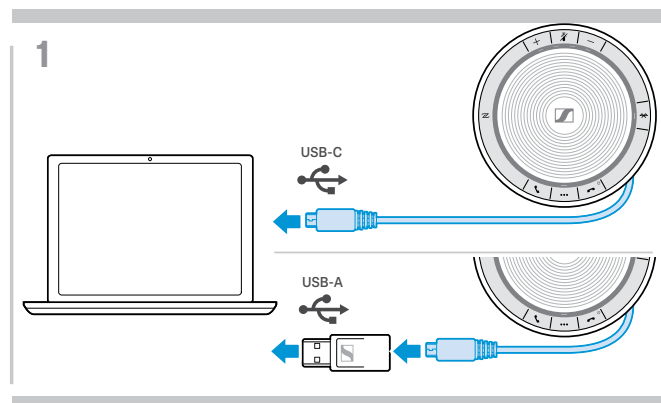

- ▷ Connect the USB connector directly to a USB-C port or to a USB-A port using the included adapter. The speakerphone turns on automatically.

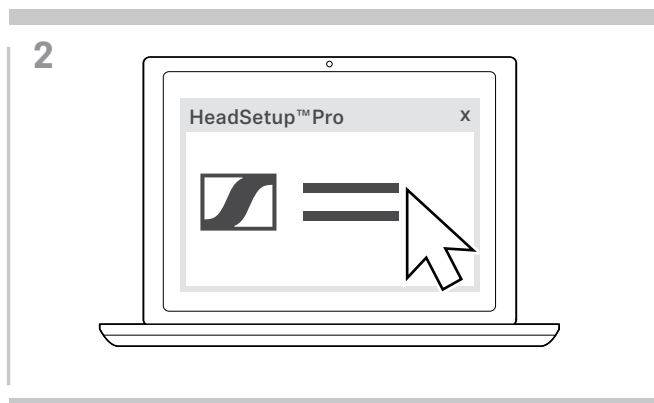

- ▷ Start [HeadSetup™ Pro](#). [HeadSetup™ Pro](#) checks if the installed firmware is the latest version available on the Sennheiser server. If required, upgrade to the latest version.

Updating the firmware of the Bluetooth dongle BTD 800 USB

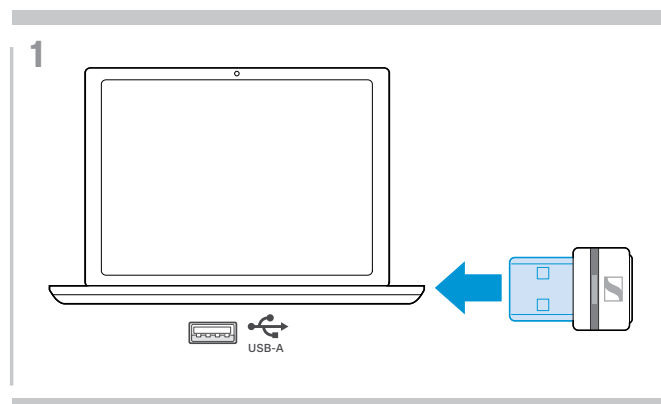

- ▷ Plug the Bluetooth USB dongle into the USB port of your computer.

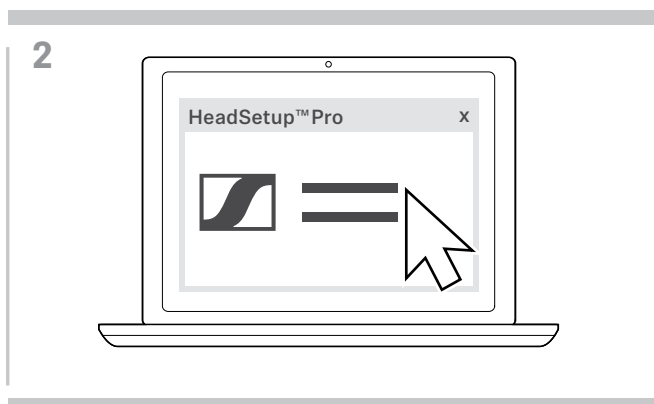

- ▷ Start [HeadSetup™ Pro](#). [HeadSetup™ Pro](#) checks if the installed firmware is the latest version available on the Sennheiser server. If required, upgrade to the latest version.

If a problem occurs ...

Problem	Possible cause	Solution	Page
Speakerphone cannot be turned on	Battery is empty	▷ Charge the battery.	24
No audio signal	USB connector not inserted correctly in the computer or adapter	▷ Plug in again.	6
	Speakerphone is not paired with the mobile device or dongle	▷ Check if the speakerphone is paired. If necessary, pair the speakerphone again.	7
	Volume is adjusted too low	▷ Increase the volume.	14
	Speakerphone is turned off	▷ Turn the speakerphone on.	12
	Computer connection: Speakerphone not selected as audio device	▷ Change the audio settings of your computer.	–
Bad audio quality	Bluetooth transmission range is exceeded	▷ Reduce the distance between speakerphone the connected Bluetooth device.	14
Speakerphone cannot be paired/connected	Pairing does not work	▷ Check if your Bluetooth device supports the Handsfree or Headset profile.	–
	Speakerphone's pairing list was cleared but it is still in the list of paired devices of the Bluetooth device	▷ Remove the speakerphone from the list of paired devices in your Bluetooth device. ▷ Pair devices again.	–
	Distance too high while pairing	▷ Reduce the distance between speakerphone the Bluetooth device.	–
	Bluetooth not enabled	▷ Make sure Bluetooth is enabled on the speakerphone and the device connecting to.	–
Activity LED is dimmed and all other LEDs off	Speakerphone in standby mode	▷ Press any button or plug in USB to end the standby mode.	22
No voice prompts announced (tones only)	Voice prompts are disabled	▷ Enable the voice prompts.	16
Speakerphone does not react to any button press	Operation of the speakerphone is faulty	▷ Press and hold the Power on/off button for 10 seconds to reboot the speakerphone.	–
		▷ Restore factory default settings.	28
No Bluetooth connection via dongle BTD 800 USB	Dongle not inserted correctly in the computer	▷ Insert the dongle again.	10
	Dongle and speakerphone not connected	▷ Pair the dongle and your speakerphone.	10
Speakerphone/dongle does not accept new devices (Pairing)	Pairing list disturbed	▷ Clear the speakerphone's list of previously paired devices.	13
		▷ Clear the dongle's list of previously paired devices.	14

If a problem occurs that is not listed in the above table or if the problem cannot be solved with the proposed solutions, please contact your local Sennheiser partner for assistance. To find a Sennheiser partner in your country, search at www.sennheiser.com.

Restoring speakerphone's factory default settings

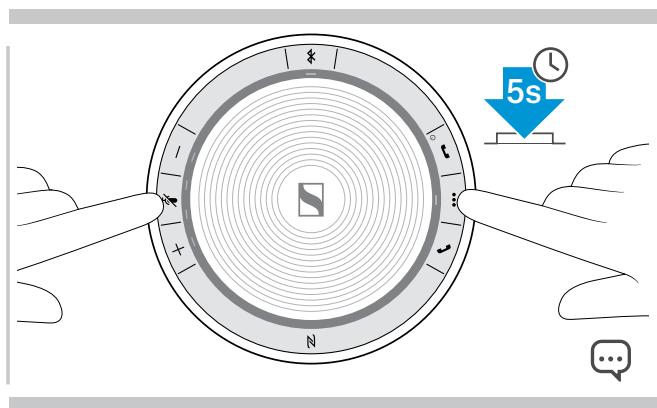

- ▶ Press and hold the mute button and multi-function button until the device restarts. All settings and the pairing list will be cleared.

Specifications

SP 30 Speakerphone

Dimensions (Ø x H)	120 x 37 mm / 4.72 x 1.47 in
Weight	approx. 314 g / 11.08 oz
Talk time	up to 18 hours
Charging time	approx. 3 h 20 min
Max. charging voltage	5 V / max. current 500 mA (computer) / 1300 mA (fast-charger)
Rechargeable battery (built-in)	Lithium Polymer; 3.7 V / 1110 mAh
Speaker type	dynamic, neodymium magnet
Speaker frequency response	Communication mode (USB / Bluetooth) 150 – 7,500 Hz Music mode (USB / Bluetooth) 100 – 20,000 Hz
Microphone type	Digital MEMS
Microphone frequency response	150 – 7,500 Hz (USB / Bluetooth)
Connector	USB-C

BTD 800 USB Bluetooth® dongle

Dimensions (W x H x D)	22 x 16 x 6 mm / 0.87 x 0.63 x 0.24 in
Weight	2 g / 0.07 oz / 0.004 lbs

Bluetooth®

Bluetooth	Speakerphone: version 5.0/ class 1 Dongle: version 4.2/ class 1
Range	up to 25 m (device-dependent)
Transmission frequency	2402 – 2480 MHz
Profiles	<ul style="list-style-type: none"> • HSP Headset Profile (version 1.2) • HFP Handsfree Profile (version 1.7) • A2DP Advanced Audio Distribution Profile (version 1.3) • AVRCP Audio Video Remote Control Profile (version 1.6) • DI Device ID Profile (version 1.3)
Output power	Speakerphone: max. 10 dBm Dongle: max. 8 dBm
Typical sensitivity	-89 dBm

Speakerphone | BTD 800 USB

Temperature range	operation: +10 °C to +40 °C / +50 °F to +104 °F storage: -20 °C to +60 °C / -4 °F to +140 °F
Relative humidity	operation: 20% to 85% storage: 10% to 95%

Trademarks

The Bluetooth® word mark and logos are registered trademarks owned by Bluetooth SIG, Inc. and any use of such marks by Sennheiser Communications A/S is under license.

The N-Mark is a trademark or registered trademark of NFC Forum, Inc. in the United States and in other countries. USB Type-C™ and USB-C™ are trademarks of USB Implementers Forum.

