

HIKVISION



Network Convert Camera

Quick Operation Guide

UD.6L0201B1295A01

www.hikvision.com

Thank you for purchasing our product. If there are any questions, or requests, please do not hesitate to contact the dealer.

About This Document

This manual applies to the following camera models.

Model
DS-2CD6412FWD-10
DS-2CD6412FWD-20
DS-2CD6412FWD-30

This manual may contain several technical incorrect places or printing errors, and the content is subject to change without notice. The updates will be added to the new version of this manual. We will readily improve or update the products or procedures described in the manual.

DISCLAIMER STATEMENT

“Underwriters Laboratories Inc. (“UL”) has not tested the performance or reliability of the security or signaling aspects of this product. UL has only tested for fire, shock or casualty hazards as outlined in UL’s Standard(s) for Safety, UL60950-1. UL Certification does not cover the performance or reliability of the security or signaling aspects of this product. UL MAKES NO REPRESENTATIONS, WARRANTIES OR CERTIFICATIONS WHATSOEVER REGARDING THE PERFORMANCE OR RELIABILITY OF ANY SECURITY OR SIGNALING RELATED FUNCTIONS OF THIS PRODUCT.

0501001040109

Regulatory Information

FCC Information

FCC compliance: This equipment has been tested and found to comply with the limits for a digital device, pursuant to part 15 of the FCC Rules. These limits are designed to provide reasonable protection against harmful interference when the equipment is operated in a commercial environment. This equipment generates, uses, and can radiate radio frequency energy and, if not installed and used in accordance with the instruction manual, may cause harmful interference to radio communications. Operation of this equipment in a residential area is likely to cause harmful interference in which case the user will be required to correct the interference at his own expense.

FCC Conditions

This device complies with part 15 of the FCC Rules. Operation is subject to the following two conditions:

1. This device may not cause harmful interference.
2. This device must accept any interference received, including interference that may cause undesired operation.

EU Conformity Statement



This product and - if applicable - the supplied accessories too are marked with "CE" and comply therefore with the applicable harmonized European standards listed under the Low Voltage Directive 2006/95/EC, the EMC Directive 2004/108/EC, the RoHS Directive 2011/65/EU.



2012/19/EU (WEEE directive): Products marked with this symbol cannot be disposed of as unsorted municipal waste in the European Union. For proper recycling, return this product to your local supplier upon the purchase of equivalent new equipment, or dispose of it at designated collection points. For more information see: www.recyclethis.info.



2006/66/EC (battery directive): This product contains a battery that cannot be disposed of as unsorted municipal waste in the European Union. See the product documentation for specific battery information. The battery is marked with this symbol, which may include lettering to indicate cadmium (Cd), lead (Pb), or mercury (Hg). For proper recycling, return the battery to your supplier or to a designated collection point. For more information see: www.recyclethis.info



Safety Instruction

These instructions are intended to ensure that user can use the product correctly to avoid danger or property loss.

The precaution measure is divided into “Warnings” and “Cautions”

Warnings: Serious injury or death may occur if any of the warnings are neglected.

Cautions: Injury or equipment damage may occur if any of the cautions are neglected.

	
<p>Warnings Follow these safeguards to prevent serious injury or death.</p>	<p>Cautions Follow these precautions to prevent potential injury or material damage.</p>



Warnings

- In the use of the product, you must be in strict compliance with the electrical safety regulations of the nation and region. Please refer to technical specifications for detailed information.
- Input voltage should meet both the SELV (Safety Extra Low Voltage) and the Limited Power Source with 24 VAC or 12 VDC according to the IEC60950-1 standard. Please refer to technical specifications for detailed information.

- Do not connect several devices to one power adapter as adapter overload may cause over-heating or a fire hazard.
- Please make sure that the plug is firmly connected to the power socket. When the product is mounted on wall or ceiling, the device shall be firmly fixed.
- If smoke, odor or noise rise from the device, turn off the power at once and unplug the power cable, and then please contact the service center.



Cautions

- Make sure the power supply voltage is correct before using the camera.
- Do not drop the camera or subject it to physical shock.
- Do not touch sensor modules with fingers. If cleaning is necessary, use clean cloth with a bit of ethanol and wipe it gently. If the camera will not be used for an extended period, please replace the lens cap to protect the sensor from dirt.
- Do not aim the camera at the sun or extra bright places. Blooming or smearing may occur otherwise (which is not a malfunction), and affect the endurance of sensor at the same time.
- The sensor may be burned out by a laser beam, so when any laser equipment is in using, make sure that the surface of sensor will not be exposed to the laser beam.

- Do not place the camera in extremely hot, cold (the operating temperature shall be $-30^{\circ}\text{C} \sim +60^{\circ}\text{C}$, or $-40^{\circ}\text{C} \sim 60^{\circ}\text{C}$ if the camera model has an “H” in its suffix), dusty or damp locations, and do not expose it to high electromagnetic radiation.
- To avoid heat accumulation, good ventilation is required for operating environment.
- Keep the camera away from liquid while in use.
- While in delivery, the camera shall be packed in its original packing, or packing of the same texture.
- Regular part replacement: a few parts (e.g. electrolytic capacitor) of the equipment shall be replaced regularly according to their average enduring time. The average time varies because of differences between operating environment and using history, so regular checking is recommended for all the users. Please contact with your dealer for more details.
- Improper use or replacement of the battery may result in hazard of explosion. Replace with the same or equivalent type only. Dispose of used batteries according to the instructions provided by the battery manufacturer.
- If the product does not work properly, please contact your dealer or the nearest service center. Never attempt to disassemble the camera yourself. (We shall not assume any responsibility for problems caused by unauthorized repair or maintenance.)

Table of Contents

1 Appearance Description	8
2 Installation	12
2.1 Installation of Block-Shaped Sensor Unit.....	15
2.1.1 Concealed Mounting	15
2.1.2 Exposed Mounting	17
2.2 Installation of Cylindrical Sensor Unit.....	19
2.3 Installation of Fixed Focal Unit	21
3 Setting the Network Camera over the LAN	25
4 Accessing via Web Browser	30

1 Appearance Description

Camera Description

The overview of the network bullet camera is shown below:

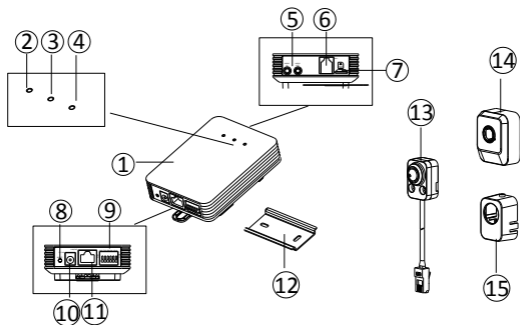

Figure 1-1 The Covert Camera with Block-shaped Sensor Unit

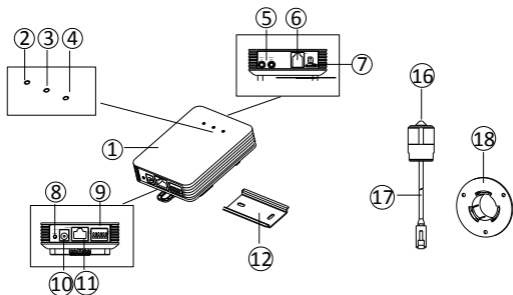

Figure 1-2 The Covert Camera with Cylindrical Sensor Unit

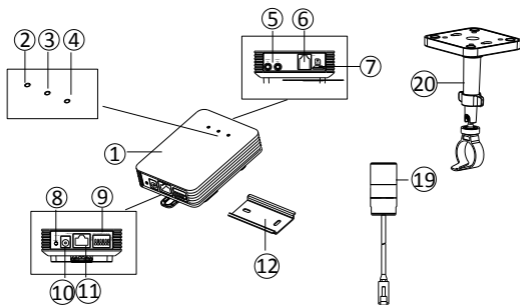

Figure 1-3 The Covert Camera with Fixed Focal Unit

Table 1-1 Description of the Camera

No.	Description	No.	Description
1	Main Unit	11	PoE & Network
2	Power Indicator LED	12	Mounting Rail
3	Status Indicator LED	13	Block-Shaped Sensor Unit
4	Link Indicator Led	14	Decorative Cover
5	Audio Interface	15	Straight Mounting Bracket
6	RJ-12 Cable	16	Cylindrical Sensor Unit
7	Micro SD Card Slot	17	RJ-12 Interface
8	RESET Button	18	Round Rail Mounting Bracket
9	RS-232 & Alarm Interface	19	Fixed Focal Camera
10	Power Interface	20	Ceiling Mounting Bracket

Table 1-2 LED Indicator

LED	Color& Status	Indicator
POWER	Solid red	On normal operation
	Unlit	Power Off
STATUS	Solid green	Camera works properly
	Unlit	Camera does not work properly.
LINK	Flashing amber	Network connection is functioning properly
	Unlit	No network connection

2 Installation

Before you start:

- Make sure the device in the package is in good condition and all the assembly parts are included.
- Make sure all the related equipment is power-off during the installation.
- Check the specification of the products for the installation environment.
- Make sure the power supply is matched with your required voltage to avoid damage.
- If the product does not function properly, please contact your dealer or the nearest service center. Do not disassemble the camera for repair or maintenance by yourself.
- Make sure that the wall is strong enough to withstand three times the weight of the camera.



For the camera that supports IR, you are required to pay attention to the following precautions to prevent IR reflection:

- Dust or grease on the dome cover will cause IR reflection. Please do not remove the dome cover film until the installation is finished. If there is dust or grease on the dome cover, clean the dome cover with clean soft cloth and isopropyl alcohol.

- Make sure that there is no reflective surface too close to the camera lens. The IR light from the camera may reflect back into the lens causing reflection.
- The foam ring around the lens must be seated flush against the inner surface of the bubble to isolate the lens from the IR LEDs. Fasten the dome cover to camera body so that the foam ring and the dome cover are attached seamlessly.

Steps:

1. Fix the standard mounting rail on the mounting surface. As shown in figure below.

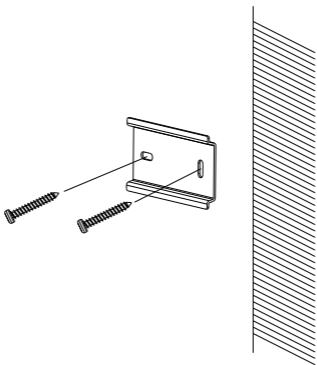

Figure 2-1 Fix the Standard Mounting Rail



- For cement surface mounting, you need to use the expansion screw to fix the camera.
 - For wooden surface mounting, you can just use the self-tapping screw to fix the camera.
2. Hang the hook which is on upper-side of the main unit onto the rail, press a little harder on the lower part of the main unit, and then the elastic clasp will be automatically buckled. As shown in figure below.

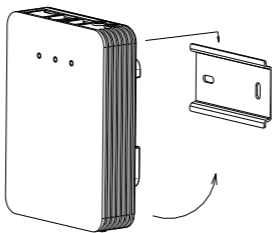

Figure 2-2 Buckle the Main Unit



If you already had a standard rail installed, you can buckle the main unit onto the installed rail directly. As shown in figure below.

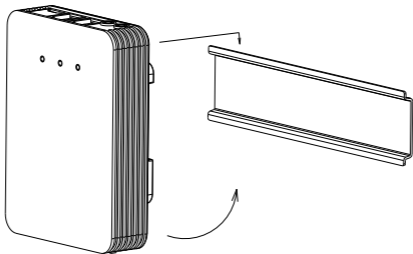

Figure 2-3 Buckle the Main Unit onto Standard Rail

2.1 Installation of Block-Shaped Sensor Unit

This series of camera support concealed mounting and exposed mounting with a decorative cover.

2.1.1 Concealed Mounting



Please make sure that the mounting surface is suitable for adhesive pasting.

Steps:

1. Drill on the mounting surface. As shown in figure below.

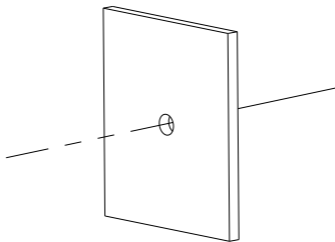

Figure 2-4 Drill on the Surface



Make sure the drilling hole is big enough for the camera lens.

2. Remove a side of the adhesive tape on the bracket. Paste the bracket on mounting surface by aligning with the drilled hole.

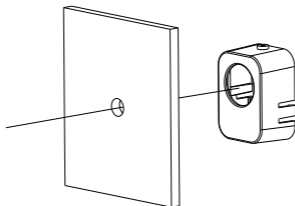

Figure 2-5 Paste the Bracket

3. Install the block-shaped sensor unit into the bracket and make it to be buckled.
4. Tighten the fastening screw on the top of the bracket.

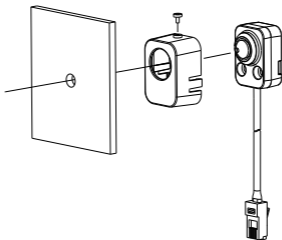

Figure 2-6 Insert the Block-shaped Sensor Unit

2.1.2 Exposed Mounting

Steps:

1. Fix the Block-shaped sensor unit on the mounting surface with screws. As shown in figure below.

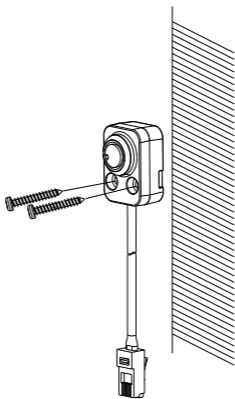

Figure 2-7 Fix the Block-shaped Sensor Unit



- For cement surface mounting, you need to use the expansion screw to fix the camera.
 - For wooden surface mounting, you can just use the self-tapping screw to fix the camera.
5. Shield the sensor unit with the decorative cover. As shown in figure below.

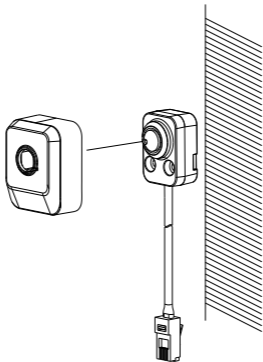

Figure 2-8 Hood the Cover

2.2 Installation of Cylindrical Sensor Unit

This series of camera only support concealed mounting.



Please make sure that the mounting surface is suitable for adhesive pasting.

Steps:

1. Drill on the mounting surface. As shown in figure below.

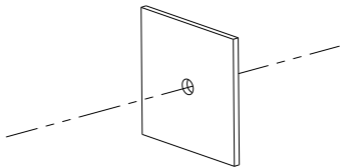

Figure 2-9 Drill on the Surface



Make sure that the drilling hole is big enough for the camera lens.

2. Remove a side of the adhesive tape on the bracket. Paste the bracket on the mounting surface with aligning with the drilling hole. As shown in figure below.

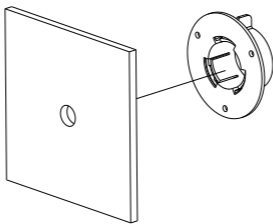

Figure 2-10 Paste the Bracket

3. Install the cylindrical sensor into the mounting hole in the round rail bracket.

4. Turn the locking sleeve to fix the sensor.

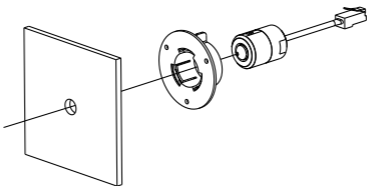

Figure 2-11 Install the Cylindrical Sensor

2.3 Installation of Fixed Focal Unit

Steps:

1. Fix the mounting base of the bracket to the ceiling with the supplied screws.

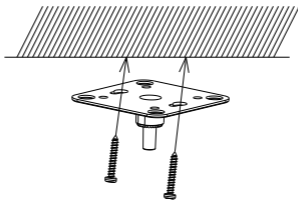

Figure 2-12 Fix the Ceiling Mounting Bracket

2. Hood the bracket cover to the mounting base.

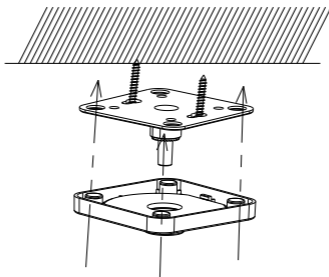

Figure 2-13 Hood the Bracket Cover

3. Screw the bracket to the mounting base.

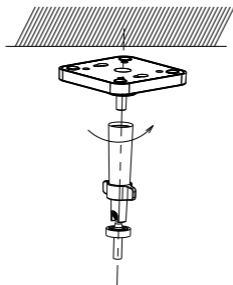

Figure 2-14 Screw the Bracket



Another shorter bracket is also selectable, please select the bracket according to your demand.

4. Loop the fixed focal unit with the loop of the bracket, and tighten it with the supplied screw. As shown in Figure 2-15.

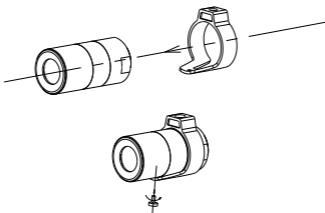

Figure 2-15 Loop the Fixed Focal Unit

5. Align the assembled fixed focal unit to the bracket, and rotate the unit to tighten the unit with the bracket.

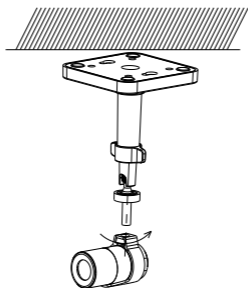

Figure 2-16 Install the Fixed Focal Unit to the Bracket

6. Loosen the knob to adjust the surveillance angle, and then tighten the lock nut to complete the installation.

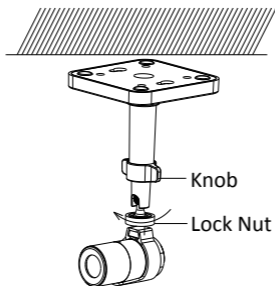

Figure 2-17 Complete the Installation

3 Setting the Network Camera over the LAN

Purpose:

To view and configure the camera via LAN (Local Area Network), you need to connect the network camera in the same subnet with your PC. Then, install the SADP or PCNVR software to search and change the IP of network camera.

- The following figure shows the cable connection of network camera and PC:

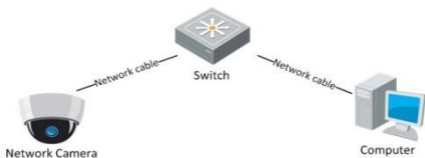

Figure 3-1 Wiring over LAN

- Set the IP address of the camera for accessing via LAN.

Steps:

1. To get the IP address, you can choose either of the following methods:
 - Use SADP, a software tool which can automatically detect network camera in the LAN and list the device information like IP address, subnet mask, port number, device serial number, device version, etc., shown in Figure 3-2.

- ❑ Use PCNVR software and to list the online devices. Please refer to the user manual of PCNVR client software for detailed information.
- 2. Change the IP address and subnet mask to the same subnet as of your PC.
Refer to the following introductions to set IP address with SADP software:

- ❑ **Search active devices online**

- Search online devices automatically:**

- After launch the SADP software, it automatically searches the online devices every 15 seconds from the subnet where your computer locates. It displays the total number and information of the searched devices in the Online Devices interface. Device information including the device type, IP address, port number, gateway, etc. will be displayed.

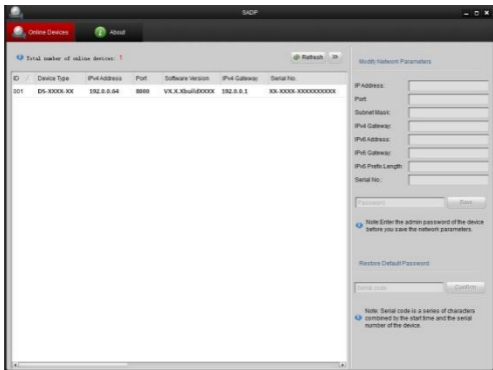



Figure 3-2 Search Online Devices







Device can be searched and displayed in the list in 15 seconds after it goes online; it will be removed from the list in 45 seconds after it goes offline.

Search online devices manually:

You can also click  to refresh the online device list manually. The newly searched devices will be added to the list.



You can click  or  on each column heading to order the information; you can click  to show the device table and hide the network parameter panel on the right side, or click  to show the network parameter panel.

□ Modify device information

Steps:

- 1). Select the device to be modified in the device list as shown in Figure 3-3. The network parameters of the device will be displayed in the Modify Network Parameters panel on the right side as shown in Figure 3-4.
- 2). Edit the modifiable network parameters, e.g. IP address and port number.
- 3). Enter the password of the admin account of the device in the Password field and click **Save** to save the changes.



ID	Device Type	IPv4 Address	Port	Software Version	IPv4 Gateway	Serial No.
001	DS-XXXX-XX	192.0.0.64	8000	VX.X.XbuildXXXX	192.0.0.1	XX-XXXX-XXXXXXXXXX

Figure 3-3 Select a Device

Modify Network Parameters

IP Address:	<input type="text" value="192.0.0.64"/>
Port:	<input type="text" value="8000"/>
Subnet Mask:	<input type="text" value="255.255.0.0"/>
IPv4 Gateway:	<input type="text" value="192.0.0.1"/>
IPv6 Address:	<input type="text"/>
IPv6 Gateway:	<input type="text"/>
IPv6 Prefix Length:	<input type="text"/>
Serial No.:	<input type="text" value="XXXXXXXXXXXXXXXXXXXX"/>

 Note: Enter the admin password of the device before you save the network parameters.

Figure 3-4 Modify Network Parameters

3. Enter the IP address of network camera in the address field of the web browser to view the live video.



- The default value of the IP address is “192.0.0.64”. The default user name is “admin”, and password is “12345”.
- For accessing the network camera from different subnets, please set the gateway for the network camera after you log in.

4 Accessing via Web Browser

System Requirement:

Operating System: Microsoft Windows XP SP1 and above version / Vista / Win7 / Server 2003 / Server 2008 32bits

CPU: Intel Pentium IV 3.0 GHz or higher

RAM: 1G or higher

Display: 1024×768 resolution or higher

Web Browser: Internet Explorer 6.0 and above version, Apple Safari 5.02 and above version, Mozilla Firefox 3.5 and above version and Google Chrome8 and above version

Steps:

1. Open the web browser.
2. In the browser address bar, input the IP address of the network camera, e.g., 192.0.0.64 and press the **Enter** key to enter the login interface.
3. Input the user name and password.
4. Click **Login**.

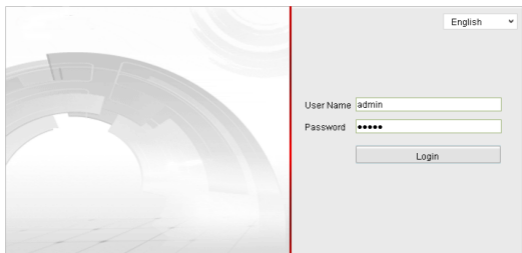

Figure 4-1 Login Interface

5. Install the plug-in before viewing the live video and managing the camera. Please follow the installation prompts to install the plug-in.



You may have to close the web browser to finish the installation of the plug-in.

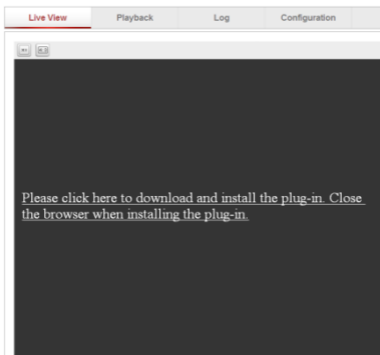

Figure 4-2 Download Plug-in

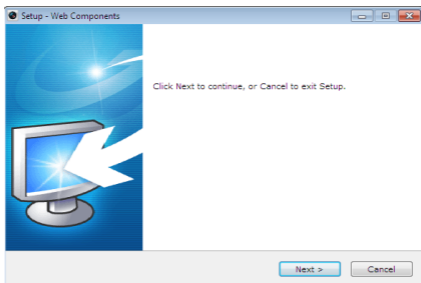

Figure 4-3 Install Plug-in (1)

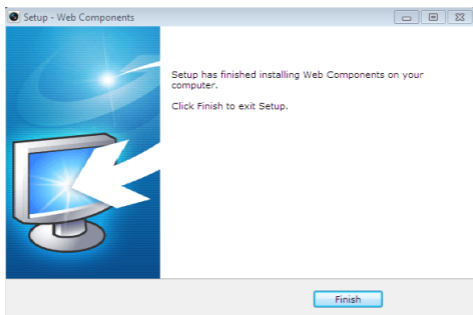

Figure 4-4 Install Plug-in (2)

6. Reopen the web browser after the installation of the plug-in and repeat steps 2-4 to login.



For detailed instructions of further configuration, please refer to the user manual of network camera.

First Choice for Security Professionals