

# Active Track

---

## Personal GPS



## Operation & Maintenance Manual

Issue: 1.4

Date issue: 2013-10-25

Firmware version: 2.0rc78

GPRS configurator version: 1.3.24.2

© 2013 EBS

# Active Track (beta version)

## Introduction

---

This Operation and Maintenance Manual describe configuration and operation of system Active Track EBS.

In case of any doubt please contact us via our Website <http://www.ebs.pl/>, email [support@ebs.pl](mailto:support@ebs.pl), or phone (+48) 22 812 05 05.

We hope you enjoy working with our devices.



## **Active Track (beta version)**

© 2013 EBS

All rights reserved. No parts of this work may be reproduced in any form or by any means - graphic, electronic, or mechanical, including photocopying, recording, taping, or information storage and retrieval systems - without the written permission of the publisher.

Products that are referred to in this document may be either trademarks and/or registered trademarks of the respective owners. The publisher and the author make no claim to these trademarks.

While every precaution has been taken in the preparation of this document, the publisher and the author assume no responsibility for errors or omissions, or for damages resulting from the use of information contained in this document or from the use of programs and source code that may accompany it. In no event shall the publisher and the author be liable for any loss of profit or any other commercial damage caused or alleged to have been caused directly or indirectly by this document.

Printed: 2013-10-25





#### DECLARATION OF CONFORMITY

We, EBS Sp. z o.o. declare under our sole responsibility that the product Active Track is in conformity with Directive 1999/5/EC of the European Parliament and of the Council of 9 March 1999.

A copy of the Declaration of Conformity can be found from <http://www.ebs.pl/certyfikaty/>



The crossed-out wheeled bin means that within the European Union the product must be taken to separate collection at the product end-of life. This applies to your device but also to any enhancements marked with this symbol. Do not dispose of these products as unsorted municipal waste.

The content of this document is presented "as is." No guarantees are provided, either stated or suspected, including but not limited to this any suspected guarantees of trade usability and any specified usefulness, unless these are required by law regulations. The Manufacturer reserves the right to introduce changes into this document and to withdraw it at any time without notice.

The Manufacturer's policy is continual development therefore reserves the right to introduce any modifications to The Product and its functions described in The Manual without prior notice.

Availability of particular functions will depend on software version. For more information turn to your nearest Dealer.

Under no circumstances is The Manufacturer liable for any data or profit loss or for any particular, accidental, resultant and indirect damage caused in any way.

This device complies with Part 15 of the FCC rules. Operation is subject to the following two conditions: (1) This device may not cause harmful interface, and (2) This device must accept any interference that may cause undesired operation.



# Contents

---

<b>1 FOR YOUR OWN SAFETY</b>	<b>9</b>
<b>2 All about accessories</b>	<b>11</b>
<b>3 Device versions</b>	<b>11</b>
<b>4 General information</b>	<b>11</b>
4.1 PIN code .....	11
<b>5 Transmission safety</b>	<b>13</b>
5.1 Data coding .....	13
<b>6 Functions review</b>	<b>13</b>
6.1 GPS module .....	13
6.2 RFID transponders reader .....	13
6.3 Controlling buttons .....	13
6.4 Work mode indicator .....	13
6.5 Loudspeaker and microphone .....	14
6.6 Accelerometer .....	14
6.7 Clock .....	14
6.8 Memory .....	14
6.9 GPRS service (General Packet Radio Service) .....	14
6.10 Before using GPRS technology .....	14
6.11 GPRS service charges .....	15
<b>7 A few words about the device</b>	<b>16</b>
7.1 Functional elements .....	16
<b>8 First steps</b>	<b>17</b>
8.1 SIM card and battery installation .....	17
8.2 Battery charging .....	19
8.3 Sleep mode .....	20
<b>9 Configuration</b>	<b>21</b>
9.1 Remote configuration .....	21
9.2 Configuration program .....	27
Computer - requirements .....	27
Program functions .....	27

File -> New .....	28
File -> Open.....	28
File -> Save .....	29
File -> Language.....	29
File -> Connections .....	29
Local connection.....	29
Remote connection.....	30
GPRS linking .....	30
CSD linking .....	31
File -> Archiving.....	32
File -> Exit .....	32
Operations -> Read.....	32
Operations -> Send.....	33
Operations -> System events history.....	33
Operations -> Device monitor .....	33
Operations -> Restore default settings.....	33
Help -> About program.....	34
<b>Programmable parameters .....</b>	<b>35</b>
Access .....	35
Parameters .....	35
Device mode.....	35
GPRS test time.....	36
SMS mode after unsuccessful attempts.....	36
SMS test time.....	36
Server phone number.....	36
Sends events via SMS immediately.....	36
APN Parameters.....	37
APN .....	37
User ID .....	37
User password.....	37
DNS1 and DNS2.....	37
Primary server parameters.....	37
Server address.....	37
Server port .....	38
Interval between subsequent connection attempts.....	38
Number of connection attempts.....	38
Always try to connect to primary server at first.....	38
Backup server parameters.....	38
Server address.....	38
Server port .....	38
Interval between subsequent connection.....	38
Number of connection attempts.....	39
Disconnect after time limit.....	39
Access .....	39
Service code .....	39
PIN of SIM card.....	39
Transmission .....	39
Device parameters.....	40
Accelerometer .....	40
ManDown .....	41
Tilt detection.....	42
RFID tags .....	42
Maximum time.....	43
Maximum number of tags.....	43

Microphone & Speaker.....	44
Microphone sensitivity.....	44
Speaker volume.....	44
Events signalling.....	44
Restore defaults.....	45
Advanced .....	45
GPS parameters.....	46
Distance .....	46
Timeout .....	46
Speed and angle.....	47
Monitoring .....	47
Events .....	47
GPRS On / GPRS Off.....	48
SMS On / SMS Off.....	48
On priority / Off priority.....	48
Additional data.....	48
Restrictions .....	50
Phone numbers.....	50
SMS authorized phones.....	51
Validity period of outgoing SMS messages.....	51
SMS limits .....	51
Notifications .....	52
Phone numbers.....	52
SMS Forward.....	53
Link control .....	53
GSM .....	54
GPRS .....	54
Firmware .....	55
<b>Device programming</b> .....	<b>56</b>
Programming adapter and cable.....	56
Local programming.....	56
Remote programming.....	57
The first programming of device.....	58
Reprogramming of device.....	58
<b>Device Monitor</b> .....	<b>60</b>
<b>Events history</b> .....	<b>61</b>
<b>10 Controlling commands</b>	<b>63</b>
<b>11 Operation rules</b>	<b>64</b>
<b>11.1 RFID transponder read-out</b> .....	<b>64</b>
<b>11.2 Sending „Panic“ command</b> .....	<b>65</b>
<b>11.3 Sending „Call me“ command</b> .....	<b>65</b>
<b>11.4 Voice connection (incoming)</b> .....	<b>65</b>
<b>11.5 Outgoing voice call</b> .....	<b>66</b>
<b>11.6 Checking GSM range</b> .....	<b>66</b>
<b>11.7 Reset and turn off</b> .....	<b>67</b>
<b>11.8 Accelerometer operation</b> .....	<b>67</b>
<b>12 Indicating work mode</b>	<b>69</b>

12.1	Registration at GSM network .....	69
12.2	GSM range .....	69
12.3	GPS positioning .....	70
12.4	RFID transponder read-out .....	70
12.5	Data transmission .....	71
12.6	Making out-going voice calls .....	71
12.7	Battery low .....	71
12.8	Battery charging .....	72
12.9	Battery full .....	72
12.10	System general error .....	72
12.11	SIM card error .....	73
<b>13</b>	<b>Cooperation with monitoring system</b>	<b>74</b>
<b>14</b>	<b>Information about batteries</b>	<b>77</b>
14.1	Battery charging and discharging .....	77
<b>15</b>	<b>Operation and maintenance</b>	<b>78</b>
<b>16</b>	<b>Exemplary implementation</b>	<b>78</b>
<b>17</b>	<b>Technical parameters</b>	<b>79</b>



# 1 FOR YOUR OWN SAFETY

---

Study the advice below carefully. Disregarding may be dangerous or illegal. More information is provided in following parts of this Manual.



Do not switch on the device where use is forbidden, as it may cause radio interference or other danger.



## **SAFETY ON THE ROAD IS OF THE UTMOST IMPORTANCE**

Do not use the device while driving a vehicle.



## **RADIO INTERFERENCE**

The device is sensitive to radio interference that can influence quality of connection.



## **DO NOT USE THE DEVICE WITHIN HOSPITAL AREA**

Follow rules and regulations. Do not switch on the device where near to medical equipment.



## **DO NOT USE THE DEVICE WHILE FILLING UP A CAR**

Do not use the device either at petrol stations or petrol and chemical depots.



## **SWITCH OFF THE DEVICE IN EXPLOSION AREA**

Do not use the device where explosives are blasted off. Pay attention to all limits and follow rules and regulations.



## **USE THE DEVICE CAREFULLY**

While talking, do not hold the device too close to your ear. Avoid touching antenna area.



## **USE PROFESSIONALS**

Get qualified service install and repair the device or its parts.



## **BATTERIES AND ACCESSORIES**

Use batteries and accessories approved by The Manufacturer only. Do not connect chargers not compatible with the device.

**WATER AND DUST RESISTANCE**

The device is dustproof and waterproof according. It is yet recommended to keep it safe from excessive dust and humidity.

**VOICE COMMUNICATION**

The device operates within: 900 MHz, 1800 MHz, 850 MHz and 1900 MHz networks. Availability of those transmission bands depends on GSM provider network. Incoming voice connection is received automatically with no need of pick-up and is finished when caller disconnects.

## 2 All about accessories

---

Before using charger, make sure it is original charger ATRACK-C – the only model the device may be charged with.

**Note:**

Use only the batteries, charger and other accessories approved by The Manufacturer to work solely with this model of the device.

Using unauthorized appliances voids guarantee for the device and may be dangerous to user. Turn to your nearest Dealer to learn more about approved accessories.

## 3 Device versions

---

Active Track is manufactured in three versions. Available functions related to RFID and GPS depends on the model.

MODEL	Active Track		
	AT-G	AT-R	AT-GR
GSM/GPRS module	•	•	•
GPS module	•	-	•
RFID	-	•	•

• built-in

- lack

## 4 General information

---

### ■ PIN code

Before first use make sure the device is properly configured. For more information go to [Configuration](#)<sup>21</sup>. Before first use get your SIM card ready: either set PIN serial code of the device or cancel PIN code request using mobile phone. Before inserting, make sure PIN card has got PIN code set on "1111" because originally the device has got PIN code set on "1111".

**Note:**

Once powered, the device verifies PIN code. PIN code is originally set on "1111". If your SIM card number is different than "1111", the card will be automatically blocked. Unblocking will be then possible only by inserting PUK code using mobile phone.

## 5 Transmission safety

---

### ■ Data coding

Safety of data sent from the device to server is guaranteed with the very safe and strong **AES** algorithm (Advanced Encryption System). Transmission is based on the GSM provider network, therefore the device uses all protections offered by provider to standard mobile phones. Turn to your provider for private APN, if you want to increase system safety.

## 6 Functions review

---

### ■ GPS module

Active Track is equipped with GPS receiver u-blox MAX 6, which allows to specify the exact position of the device anywhere in the world.

### ■ RFID transponders reader

Depending on device model, have built-in RFID transponders reader located inside the device cover.

For more information, go to [RFID transponder read-out](#)<sup>[70]</sup>.

### ■ Controlling buttons

The device has got four controlling buttons: „Checkpoint“, „Panic“, „Call to me/Emergency“ and „GPS“.

For more information, go to [Operation rules](#)<sup>[64]</sup>.

### ■ Work mode indicator

The device indicates work mode by highlighting buttons with LED diodes.

For more information, go to [Indicating work mode](#)<sup>[69]</sup>.

## ■ Loudspeaker and microphone

The device may be used as a mobile phone. The incoming calls can be limited to a user-defined phone number list (see chapter [Phone numbers...](#)<sup>[50]</sup>) and outgoing calls can be allowed only to a predefined number (see [Phone numbers](#)<sup>[52]</sup>). You will find more detailed information on receiving and making calls with the device in points [Voice connection \(incoming\)](#)<sup>[65]</sup> and [Outgoing voice call](#)<sup>[66]</sup>.

## ■ Accelerometer

The device can detect its current location and its change against the axis of the Earth's gravitational field. You will find more information on uses of the detector and its operation in points [Accelerometer](#)<sup>[14]</sup> and [Accelerometer operation](#)<sup>[67]</sup>.

## ■ Clock

The device is equipped with real time clock powered by battery. For more information, go to [Remote configuration](#)<sup>[21]</sup>.

## ■ Memory

The device has got memory buffered to 1000 events, stored when out of range and sent out immediately after range is restored.

## ■ GPRS service (General Packet Radio Service)

GPRS service allows receiving and sending data through GSM network basing on IP (Internet Protocol). It is data medium which enables wireless access to Internet. It is possible to send SMS text messages simultaneously with GPRS transmission.

## ■ Before using GPRS technology

For more information, availability and GPRS service booking conditions turn to your GSM provider or service distributor.

---

## ■ **GPRS service charges**

For more information turn to your GSM provider or service distributor.

## 7 A few words about the device

### ■ Functional elements

#### 1. GPS button

Sends emergency SMS with optional location. This button is additionally highlighted in green, showing GPS status.

#### 2. Checkpoint button (optional Read-out button)

Sends checkpoint event to server. In device version with built in RFID transponders reader it activates RFID circuit transponders for 15 seconds. This button is additionally highlighted in yellow, showing GSM status.

#### 3. Call to me button

Sends "Call to me" report to server or makes a voice call to defined phone number. This button is additionally highlighted in blue, showing charging status.

#### 4. Panic button

Sends "Panic" report to server.  
This button is additionally highlighted in red.

#### 5. LED indicator

Shows proper charger status.

#### 6. Loudspeaker

For voice communication with user or generation of acoustic signals.

#### 7. Battery lid

Closed with three bolts.

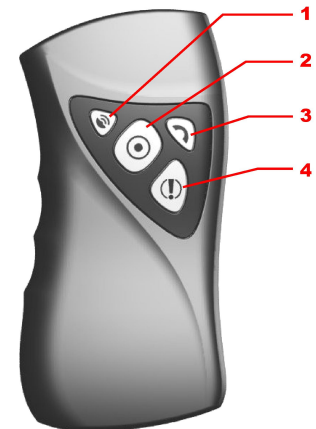



**8. Microphone**

For voice communication with user.

**9. Charging connectors**

For charging battery.

**10. Charger connector**

Micro USB connector for power supply unit.

## 8 First steps

---

### ■ SIM card and battery installation

- All SIM cards should be kept out of reach of children.
- SIM card and its connectors may be easily damaged by scratching or folding.
- Special attention while inserting and removing is therefore recommended.
- Remove battery before inserting SIM card.

Follow these instructions to remove battery:

1. Turn the device upside down, open lid by unscrewing bolts and take it off.



2. Open the cover on the SIM slot and insert SIM card to holder. Make sure golden connectors are directed downwards and close cover.



3. Insert battery. Connect battery connector to outlet in battery cavity. The connector shape prevents from incorrect placing of battery – in case of trouble with placing turn battery round and try again.



4. Lay down wires and close lid by screwing bolts.



## **Battery charging**

### **Note:**

Using chargers other than advised by The Manufacturer voids guarantee for the device and may damage it. Current voltage source must be coherent with that provided on charger's nominal plate.

The device marked with 230V may be supplied from main socket directly.

The device can be turned off from the network by unplugging the power plug from the wall socket. The socket must be easily accessible - not pledged.

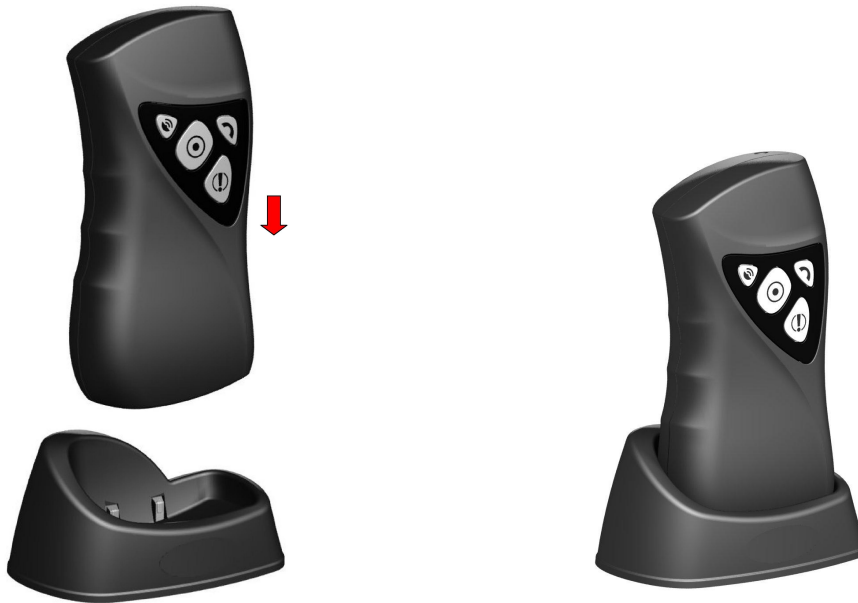

Battery charging is automatic and there is no risk of overcharge. Charging time depends on battery load. In case of fully discharged battery it should persist about 4,5 hours.

When the device signals battery low (for more information, go to [Indicating work mode](#)<sup>[69]</sup>), start charging. Place it as shown in diagram above.

Charging and its completion is signalled by the device (for more information, go to [Indicating work mode](#)<sup>[69]</sup>)

**Note:**

If the device does not signal charging when in charger, make sure charger is plugged in and the device is placed properly.

## ■ Sleep mode

The device is able to record such events like casing opening even when main battery is fully discharged. It is possible thanks to auxiliary battery and special sleep mode in which device consumes very low amount of power. The device automatically switches to sleep mode when voltage of main battery is very low.

Sleep mode:

- very low power consumption
- casing opening and shock events recorded only
- limited sound and visual notifications

- no connection to monitoring station

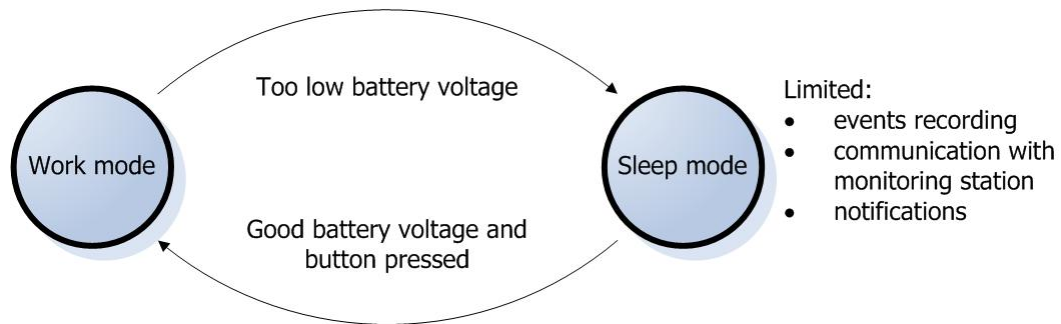

### Note:

The device goes back from sleep into work mode when main battery voltage level is good enough and after pressing any of the buttons located on the devices's casing.

## 9 Configuration

After powering-up properly configured device, it automatically connects to the receiver of monitoring system (e.g. OSM.2007). No further action required.

There are two configuration methods:

- with SMS commands, containing data required for establishing connection with the monitoring system receiver, see chapter [Remote configuration](#)<sup>[21]</sup>,
- with **GPRS transmitters configuration** programme, establishing connection with the device through appropriate RS232 cable or using GPRS connection, see chapter [Configuration program](#)<sup>[27]</sup>.

Only the second method permits access to all programmable parameters of the device. Nevertheless, in order to use a GPRS connection using this method (e.g. when programming cable is not available) the device should first connect with the monitoring system receiver using the first method (SMS configuration).

### ■ Remote configuration

Configuration of Active Track device consists in sending SMS message to the device or using GPRS (e.g. using OSM.2007 monitoring receiver). These steps enables connection to server and makes all device function available.

In case of SMS message, the message consists of parameter names and its values. Each SMS message begins user defined access code, which in a particular case may be empty. When sending more than one parameter, they need to be separated by space character.

You may configure following parameters:

**SERVER=server's\_address**

Specifies IP number or domain name of the computer Server Software is installed at. Server must be connected to the Internet with static and public IP number.

**PORT=server's\_port**

Enters port of server which monitors incoming data on the server.

**APN=apn**

Access point to network. APN is available at your GSM Provider.

**UN=apn\_user\_name**

APN user name. UN is available at your GSM Provider.

**PW=apn\_user\_password**

APN user password. PW is available at your GSM Provider.

**Attention:** These parameters are needed to establish connection with communication server. If receiving device is OSM.2007 (Monitoring System Receiver made by EBS), then configuration steps of Active Track device consists in:

- send SMS message with described on the previous page parameters (SERVER, PORT, APN, UN and PW),
- wait until device connects to the server,
- remaining parameters send over GPRS link, using Console function of OSM.2007

**TPERIOD=time\_in\_minutes**

Defines time between following tests, which are sending to server through GPRS link. If no parameter is programmed, device will use default value - 1 minute.

If value ends with letter „s“ time will be recognized in seconds. Minimal interval between tests is 10 seconds.

**DNS1=dns1**

Specifies primary DNS server address and should be defined only if is obligatory.

**DNS2=dns2**

Specifies secondary DNS server address and should be defined only if is obligatory.

**DIAL=N,Telephone\_number,M**

Telephone numbers which will be recognized as authorised numbers. All other incoming calls will be automatically disconnected.

<b>N</b>	Identification number of telephone number (1 ... 8). User can define up to 8 telephone numbers.
<b>Telephone number</b>	Authorized telephone number (or its part – device checks sequence of numbers in telephone number). Entering "RING" word enables receiving all incoming calls.
<b>M</b>	Number of rings before answering the incoming call. Available range: 0 to 9. 0 means instantaneous answer.

**EMERGENCY=Telephone\_number**

Emergency telephone number. Enables direct connection of device with chosen telephone number in case of emergency. To make a call push "Call me"/"Help me" button. Button must be hold down until two short acoustic signals from the device.

**SMS=Telephone\_number**

Defines telephone number for sending SMS messages. That number is used in case of no GPRS connection. SMS message is encrypted and can be received and decrypted by server with connected GSM modem. When no telephone number is programmed, SMS sending option will be deactivated.

**AUTH= Telephone\_number**

Telephone number which is allowed to send configuration SMS message to Active Track device. Messages are sending in plain-text, without encryption. This option limits remote access to the device (through SMS messages). When no telephone number is programmed, SMS messages will be accepted from any number.

**Note:**

Authorization of incoming SMS message relies on comparing telephone number of incoming message with number saved in memory of Active Track device. It is possible to save only part of telephone number in device. In this case all telephone numbers which contains saved sequence will be authorized. For example: saved sequence "1234" will authorize telephone numbers such as: 600123456 or 601234567.

**DT=YY/MM/DD, hh:mm**

Sets date and time in the device.

**TCPCONN=init,change,limit**

Defines time dependencies between connections to server attempts. After first failed attempt, next will occur according to these parameters:

init – initial time value (in minutes) after which connections attempts starts  
 change – defines how to change time period between attempts:  
     geometric progression - \*x.yy, where x.yy is time in minutes with  
     1/100min precision  
     arithmetic progression - +x, where x is time in minutes  
 limit – maximum time between attempts.

Example 1.

TCPCONN=2,+1,5

Defines that after first failed attempt, next will occur after 2 minutes. If second try will fail, time period will be increased by 1 minute (so next attempt will occur after 3 minutes). Time period is limited to 5 minutes (parameter: limit). Next attempts will occur after 5 minutes periods. If server is disconnected, attempts to connect will look like that (P means connection attempt, digit means time period in minutes): P, 2, P, 3, P, 4, P, 5, P, 5, P, 5, P, .....

Example 2.

TCPCONN=1,\*1.5,4

Defines that after first failed attempt, next will occur after 1 minute. If second try will also fail time period will be multiplied by 1.5, and next one will occur after 1.5 minutes. Each next time period will be multiplied by 1.5 until reach of 4 minutes. Next attempts will occur after 4 minutes. If server is disconnected, attempts to connect will look like that (P means connection attempt, number means time period in minutes): P, 1, P, 1.5, P, 2.25, P, 3.38, P, 4, P, 4, P, .....

Default value: 1,+0,1

**VOLUME=a,b,c,d,e,f, g**

Defines method of signaling certain events. For each event different method of signaling can be defined. Methods are:

- 0 – no acoustic signal, no vibration
- 1 – quiet acoustic signal, no vibration
- 2 - loud acoustic signal, no vibration
- 4 – no acoustic signal, vibration
- 5 – quiet acoustic signal, vibration
- 6 – loud acoustic signal, vibration

Order of events, which can be signaled with acoustic signal or vibration:

- a) Start RFID loop
- b) Read RFID confirmation
- c) Discharged battery warning
- d) Incoming voice call
- e) SMS message received
- f) EMERGENCY call started



g) prealarm signalling (eg. ManDown)

**Note:**

It is not necessary to give all the parameters, only the first X, for example: **VOLUME=2** sets the signal only for start RFID loop, the other parameters remain unchanged. As a consequence, to set the parameter to the position of N all preceding parameters should also be set. For example, you can not set signaling for "c) Discharged battery warning" without giving "a) Start RFID loop" warning and "b) Read RFID confirmation" in correct order.

**RFID=t,n**

(this parameter is only for device version with built in RFID transponders reader)

Enables several RFID tags read-out after one push of Read-out button.

Parameters of this option:

**t** - sets maximum time between different RFID tags read-outs,

**n** - maximum number of RFID tags that can be read after single push of Read-out button (if n=0 then there is no limit)

**TCPWDT=t**

sets TCP link control, defines times between lost of TCP connection and reset of GSM modem

**t** – time period [in minutes, range: 5 - 999]

To disable this function **t** must be an empty string.

**GSMWDT=t**

Sets GSM link control, defines time between lost of GSM connection and reset of GSM modem.

**t** – time period [in minutes, range: 5 - 999]

To disable this function **t** must be an empty string.

**GETCFG**

Gets primary communication parameters of device in form: SERVER PORT APN  
UN PW SMS TPERIOD

**KILL**

Sending this command remotely resets the device.

Example of SMS configuration text message (access code is 1111, skip quotes):

```
"1111 APN=PGuard.gprs UN=PGuard PW=PGuard_pass SERVER=gprs.com  
PORT=6670 DIAL=1,600112233,0 DIAL=2,500445566,3 DIAL=3,600778899,3  
SMS=500445566 DT=05/12/15,13:04 TPERIOD=5"
```

Example of SMS configuration text message (access code is empty, the first is a space)

character, skip quotes):

```
" APN=PGuard.gprs UN=PGuard PW=PGuard_pass SERVER=gprs.com PORT=6670  
DIAL=1,600112233,0 DIAL=2,500445566,3 DIAL=3,600778899,3 SMS=500445566  
DT=05/12/15,13:04 TPERIOD=5"
```

**Note:**

- Names of programmed parameters (e.g. SERVER) must be in upper-case letters (see example above).
- After changing configuration of Active Track, device must be restarted with **KILL** command

## ■ Configuration program

**GPRS transmitters configurator** may be downloaded at [www.ebs.pl](http://www.ebs.pl) (login: ebs, password: ebs). To install program an installation wizard shall be started that performs installation in default place C:\Program Files\EBS\. During installation process shortcuts on screen and Windows menu are created.

If device is to be used for the first time it shall be programmed with the above program and after this procedure the SIM card may be inserted into the device. Otherwise SIM card may be blocked if wrong PIN code is entered. Alternatively SIM card may be used along with switched off PIN code.

In case of remote programming it is necessary to insert SIM card prior to sending configuration settings. In this situation SIM card with switched off PIN code shall be used or before card inserting, PIN code shall be changed to 1111 with mobile phone.

### 9.2.1 Computer - requirements

Minimum requirements for computer system where configuration software is to be installed:

#### Hardware:

- Processor Pentium II 400 MHz,
- 64 MB RAM,
- 1 GB HD.
- RS-232 serial port
- Colour monitor (minimum 15 inch , min. 800x600 resolution),
- Keyboard
- Mouse
- AGP3 programming adapter and LX-PROG programming cable (for local programming)

#### Software:

- Operation system Windows 2000, Windows XP, Windows Vista or Windows 7.
- NET Framework 2.0 (delivered along with installation wizard of configuration).

### 9.2.2 Program functions

After installation and program starting a main view shall be displayed on screen. Thanks to this view an access to program or programmable parameters of device is possible. (See [Programmable parameters](#)<sup>[35]</sup>).

Main window of program is divided into some fields.

**Main menu:** at upper part of window, contains control and configuration options.

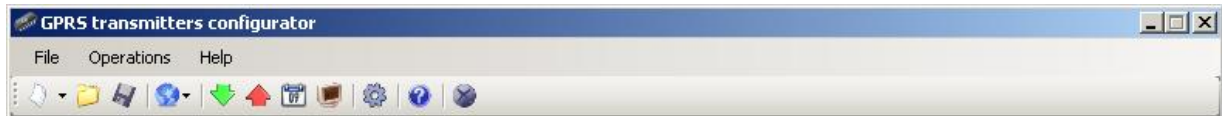

Main menu contents:

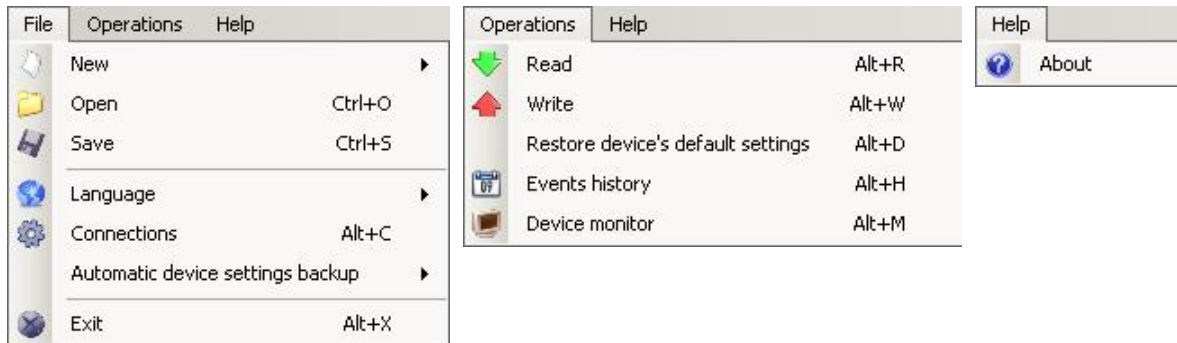

**Main menu** is available as icons on fast access bar:



### 9.2.2.1 File -> New

Opens new set of parameters. Editing of configuration parameters is possible.



Select type of device.

### 9.2.2.2 File -> Open

If file contains saved settings, they may be used to program next device. Firstly a catalogue where file has been saved shall be chosen and then name of file shall be provided. Obtained data collection may be modified by the user. Any amendments are effective if send to device.

### 9.2.2.3 File -> Save

During programming many devices in different configurations, it is not necessary to have in mind each one as it may be saved on hard disc or floppy disk under any name and it may be loaded later on. This function save on disc any information from configuration wizard window. After activation of function a dialog window appears with request to provide file name. Default data is saved with **CMI** extension (Configuration Memory Image).

### 9.2.2.4 File - > Language

Allows for selection of any available languages (determined in attached exterior language files).

### 9.2.2.5 File -> Connections

Before programming of devices, a connection type shall be defined. It is possible to do it with two methods:

- locally
- remotely.

#### 9.2.2.5.1 Local connection

Local connection means that configuration software (namely computer on which is installed) is directly connected to proper terminal of transmitter. Connection is possible owing to special wire and through RS-232 serial port.

To program device or make any other operations (e.g. reading of device settings, firmware amendments, etc.) it is necessary firstly to define connection parameters.

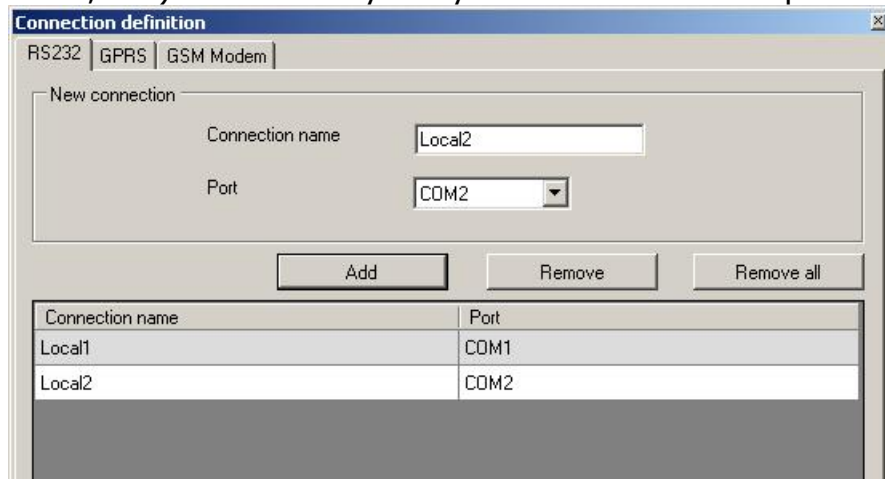

It is possible to do so with the above window that is available after activation of connection from Main Menu and selection Configuration tab or after clicking on  icon on fast access bar and clicking on RS-232 tab.

Define:

Name of connection e.g. Locally

Choose serial port e.g. COM 4

Click on [Add] button to confirm settings. Connections shall be saved (and inserted in table). From this time on program shall enable wires connection with device and reading, and saving of parameters in Active Track memory will be possible.

#### 9.2.2.5.2 Remote connection

As provided above the device and software makes for complete configuration with GPRS link or CSD channel. This programming mode requires definition of linking parameters.

##### 9.2.2.5.2.1 GPRS linking

Activate file in Main menu and select Connection function (or after clicking on  icon on fast access bar) and click on GPRS tab to carry out configuration of this mode.

On screen the following window shall appear:

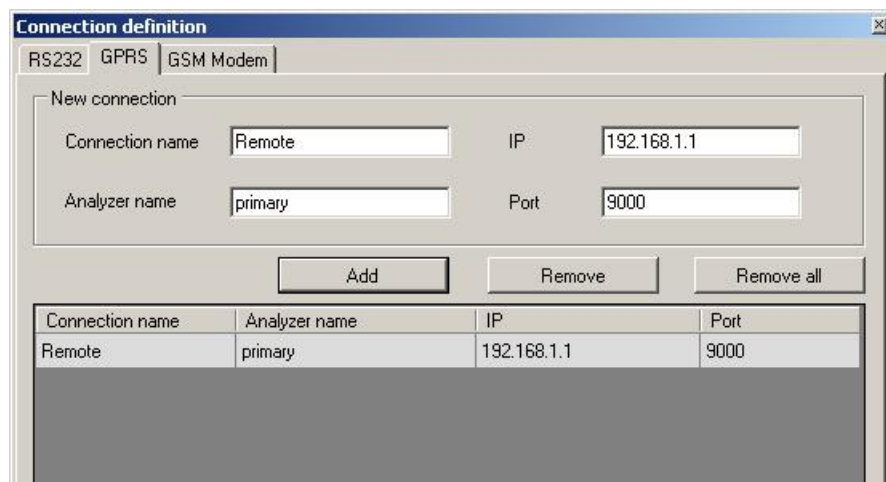

Connection name	Analyzer name	IP	Port
Remote	primary	192.168.1.1	9000

Define:

- Name of connection e.g.: **Remote**
- Select name of analyzer e.g.: **Primary**
- Enter analyzer address e.g.: **87.128.125.8**
- Enter port on which analyzer operates e.g. **7000**

Click on [Add] button to confirm settings. Connections shall be saved (and inserted in table). From this time on program shall enable remote connection to device and reading and saving of parameters in Active Track memory shall be possible.

**Note:**

The following parameters: analyzer name, analyze address, port relate to settings of OSM.2007 receiver of monitoring system. Remote programming is available only if above mentioned device (or software) is used.

## 9.2.2.5.2.2 CSD linking

Activate file in Main Menu and select Connection function (or after clicking on  icon on fast access bar) and click on GSM Modem tab to carry out configuration of this mode.

On screen the window shall appear where it is possible to define:

- Name of connection e.g. Remote CSD
- Serial port where GSM modem is connected (e.g. Wavecom Fastrack)
- PIN code of SIM card installed in GSM modem e.g. 1111
- Serial port parameters: amount of bytes/sec. (e.g. 115200), data bytes (8), parity (none), stop bits (1)
- optional phone number of the SIM card installed in the modem

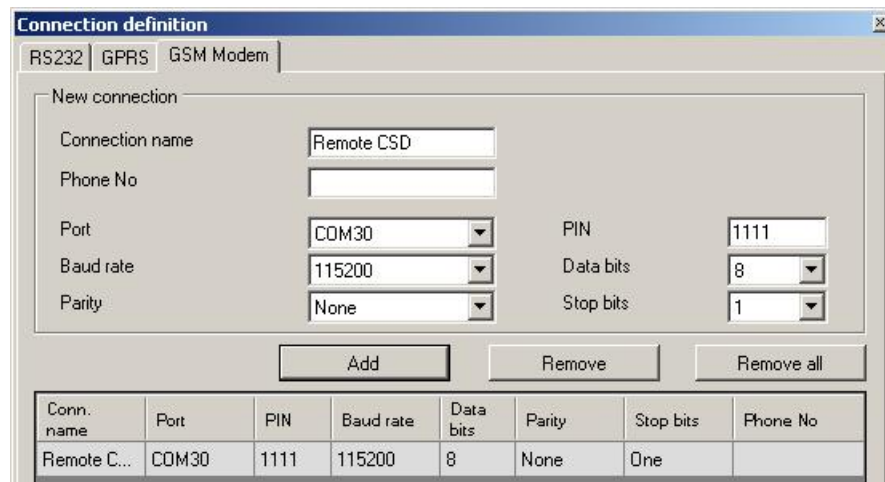

Conn. name	Port	PIN	Baud rate	Data bits	Parity	Stop bits	Phone No
Remote C...	COM30	1111	115200	8	None	One	

Click [Add] button to confirm settings and save connection (settings are inserted into table). Since that time a remote connection to device, reading and saving of parameters in Active Track memory is possible.

**Note:**

Remote configuration with CSD canal is possible if option of CSD data sending has been activated both for SIM card inserted into a device and SIM card installed in GSM modem. Beside, Active Track transmitter must enable to pick up data calls (see GSM modems authorized phones)

Programming with CSD is also possible if OSM.2007 system has been installed, and minimum one GSM modem is connected. If device has been entered onto server list (factory number and SIM card telephone number –See OSM.2007 Operation Manual) it is possible to use link via OSM. It is possible if device is not connected to the

OSM.2007 via GPRS. During programming procedure (with GPRS link- See above) a question will be displayed if user wants to use a modem connected to the server. After confirmation procedure will follow as in case of other programming channels.

#### 9.2.2.6 File -> Archiving

All configuration settings including reread from devices and saved on devices are to be automatically saved on hard disc. If during installation on configuring tool settings have not been changed, files will be saved as follows:

C:\Program Files\EBS\KonfiguratorLX\configs\Active Track\_80000

Catalog Active Track\_80000 contains all files in respect of Active Track with factory number of 80000 programming. The name contains date and time of operation and its type (saving/ reading). Files have **CMI** extension.

#### 9.2.2.7 File -> Exit

Finishes program operation.

#### 9.2.2.8 Operations -> Read

Function reads data saved in memory of GPRS module. Exchange of data follows on port selected in section "Select Connection Type" (See below description of option "Configuration"). Correct reading is confirmed with message on a screen. Data downloaded from device may be saved on file (see clause 6.3.3) and use for other devices.

To use this function it is necessary to define type and parameters of connection. E.g. for local connection the following view is displayed:



where:

Connection kind - serial port to which module is connected

Access code- service code of transmitter

Detailed description of connections configuration is included in clause [File -> Connections](#)<sup>29</sup>.



### 9.2.2.9 Operations -> Send

This function is analogical to the above one, at the same time it enables data saving into EEPROM module. There is also possibility to set correct time into Active Track device. Correct saving is confirmed with message on a screen.

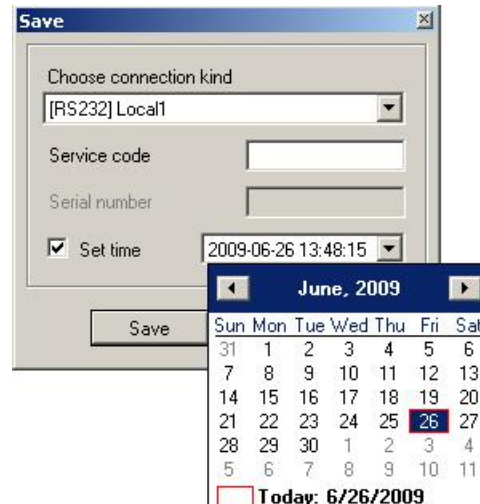

### 9.2.2.10 Operations -> System events history

„Events history” provides information about last events stored in Active Track device memory. See chapter [Events history](#)<sup>61</sup>

### 9.2.2.11 Operations -> Device monitor

„Device Monitor” provides real-time information on Active Track device state. See chapter [Device Monitor](#)<sup>60</sup>

### 9.2.2.12 Operations -> Restore default settings

If operation “Read” finishes with error message (e.g. if access code is unknown) it is possible to come back to default settings by selecting “Restore default settings”. On the screen the will appear following message “Do you want to overwrite current configuration with default values?” After confirming the following window shall appear:



This operation is possible only with local connection. After operation completing device parameters shall come back to default settings.

### 9.2.2.13 Help -> About program

Select this function to view additional information about program.

## 9.2.3 Programmable parameters

Parameters available in configuration program are divided into three groups: Access, Transmission, Device parameters, Monitoring, Restrictions, Notifications, Link control and Firmware. Each of these groups will be described in detail in next part of this manual.

### 9.2.3.1 Access

The screenshot displays the 'GPRS transmitters configurator' software interface. The window title is 'GPRS transmitters configurator' and it has a menu bar with 'File', 'Operations', and 'Help'. The interface is divided into several sections:

- Left sidebar:** A vertical list of configuration categories: 1. Access (selected), 2. Transmission, 3. Device parameters, 4. GPS Parameters, 5. Monitoring, 6. Restrictions, 7. Notifications, 8. Link control, and 9. Firmware.
- Parameters section:** Contains a dropdown menu for 'Device mode' set to 'GPRS & SMS', a 'GPRS test time' spinner set to 60 [s], an 'SMS mode after unsuccessful attempts' spinner set to 1, a checked 'SMS test time' spinner set to 10 [min], and a 'Server phone number' text field. There is also an unchecked checkbox for 'Send events via SMS immediately'.
- Primary server parameters section:** Includes 'Server address' and 'Server port' text fields, an 'Interval between subsequent connection attempts' spinner set to 70 [s], and a 'Number of connection attempts before switching to backup server' spinner set to 3. A checked checkbox 'Always try to connect to primary server at first' is present.
- APN parameters section:** Features a dropdown menu for APN selection with '+' and '-' buttons, and text fields for 'APN', 'User ID', 'User password', 'DNS1', and 'DNS2'.
- Backup server parameters section:** Includes 'Server address' and 'Server port' text fields, an 'Interval between subsequent connection attempts' spinner set to 70 [s], and a 'Number of connection attempts before switching to primary server' spinner set to 3. A checked checkbox 'Disconnect after' is followed by a spinner set to 300 [s].
- Access section:** Contains text fields for 'Service code' and 'SIM card PIN'.

At the bottom of the window, there is a status bar with the following information: 'Type: Active Track | SN: | Firmware version: / | 12:42:02'.

#### 9.2.3.1.1 Parameters

##### 9.2.3.1.1.1 Device mode

Depending of user preferences, a device may operate in 1 out 3 modes (available from scrolled list):

- GPRS & SMS: GPRS standard transmission (TCP/IP Protocol), and if any problems follow with this link it automatically SMS mode will follow.
- SMS: Transmission only in SMS mode, without trial to establish GPRS link.
- GPRS: GPRS standard transmission (TCP/IP Protocol), and in case of any problems with this link no transmission will follow.

#### 9.2.3.1.1.2 GPRS test time

The device sends signal "Test" with determined interval that informs monitoring station that the device is in operation mode. In this field you can determine how often this message will be sent (in seconds) .

**Note:**

This field will be inactive if device is to operate in SMS mode.

#### 9.2.3.1.1.3 SMS mode after unsuccessful attempts

Define number of reconnections to server. If during all reconnections fail the device will go into SMS mode. In this mode Active Track will try to make connection with server, according to interval defined in clause [Interval between subsequent connection attempts](#)<sup>38</sup>.

**Note:**

This field will be active if device is to operate in GPRS & SMS mode.

#### 9.2.3.1.1.4 SMS test time

This function is analogical to GPRS. It is activated when problems with GPRS transmission follow when the device automatically goes into SMS mode (it relates to operation mode in SMS). Usually it is undesirable to send text as SMS so often as with GPRS transmission. Parameter this allow for significant extension of distance between tests (time in minutes) or completely interlocking of this option.

**Note:**

This field will be inactive if device is to operate in GPRS mode.

#### 9.2.3.1.1.5 Server phone number

If GSM modem is connected to server application (e.g. OSM. 2007) enter in this field its number. Any SMS will be sent to this number if transmitter has got problems with GPRS transmission. If this field is left blank or 0 was entered, the transmitter will be operating exclusively in GPRS mode.

**Note:**

This field will be inactive if device is to operate in GPRS mode.

#### 9.2.3.1.1.6 Sends events via SMS immediately

In case of GPRS connection lost device will send SMS reports immediately, even if the Active Track isn't in SMS mode yet.

**Note:**

This field will be inactive if device is to operate in GPRS mode.

### 9.2.3.1.2 APN Parameters

**Note:**

This group will be inactive if device is to operate in SMS mode.

#### 9.2.3.1.2.1 APN

Parameter depending on GSM network operator that supplies GPRS (SMS) services. It provides GSM network access point name.

It possible to obtain a private access point. In this case a name will be provided by GSM network operator.

#### 9.2.3.1.2.2 User ID

When using public APN , user ID is mostly not required. For private APN this parameter shall be obtained from operator (it is impossible to be granted access to GPRS network without it).

#### 9.2.3.1.2.3 User password

When using public APN , user ID is mostly not required. For private APN this parameter shall be obtained from operator (it is impossible to be granted access to GPRS network without it).

**Note:**

Private APN provides for higher system security.

#### 9.2.3.1.2.4 DNS1 and DNS2

It determines address of main and backup DNS server (Domain Name System).

If IP server address has been entered in form of domain it is required to provide minimum one DNS address.

### 9.2.3.1.3 Primary server parameters

**Note:**

This group will be inactive if device is to operate in SMS mode.

#### 9.2.3.1.3.1 Server address

It is address of receiver of monitoring system (OSM.2007) or computer where "Communication Server" software has been installed , e.g. 89.123.115.8. This address may be provided in domain name of server, e.g. module.gprs.com. In this case it is required to provide minimum one address of DNS server.

#### 9.2.3.1.3.2 Server port

It determines server port that was selected in server for collection of data from transmitter.

#### 9.2.3.1.3.3 Interval between subsequent connection attempts

Programmable and equipped with SIM card device will try to make automatic connection with server. In this field you define interval (in seconds) after which next connection will follow if the previous connection failed.

#### 9.2.3.1.3.4 Number of connection attempts

In this field you determine how many times device will try to make connection to server. If connections fail, Active Track after execution of some connection will start procedure of connection to backup server. This option is active only if we define parameters of backup server.

#### 9.2.3.1.3.5 Always try to connect to primary server at first

Mark this check box means, that the device will try in first order to connect to primary server, without regard on definition of parameters for backup server (in peculiarity of number of connection attempts).

#### 9.2.3.1.4 Backup server parameters

**Note:**

This group will be inactive if device is to operate in SMS mode.

##### 9.2.3.1.4.1 Server address

It is IP address of second (backup) receiver of monitoring system (OSM.2007) or computer where "Communication Server" software has been installed, e.g. 89.130.125.82. This address may be provided in domain name of server, e.g. monitor.gprs.com. In this case it is required to provide minimum one address of DNS server.

##### 9.2.3.1.4.2 Server port

It determines server port that was selected in server for collection of data from transmitter.

##### 9.2.3.1.4.3 Interval between subsequent connection...

If device can not connect to primary server defined this after exhaustion for him number of attempts, it will begin realizing the procedure of connecting to backup server. We in this place define space of time (in seconds), after which test will connecting renewed if previous finished with failure.

#### 9.2.3.1.4.4 Number of connection attempts

In this field you determine how often device will try to make connection to backup server. If connections fail, Active Track after execution of some connection will back to procedure of connection to primary server.

#### 9.2.3.1.4.5 Disconnect after time limit

If you mark this choice field the device will disconnect from back up server after passage of set time. Further operation depends on defined parameter Order of connection (See clause [Always try to connect..](#)<sup>38</sup>). If this option is active the device reconnects to the primary server. If this option is not active the device firstly completes connection to backup server procedure and if this fails, the device will try to connect to the primary server.

#### 9.2.3.1.5 Access

##### 9.2.3.1.5.1 Service code

It provides security against unauthorized access. It is being used during programming of device and during remote controlling (in TCP/IP or SMS mode). Factory setting is 1111. During the first starting of device (programming) it shall be changed. Code may consist of up to seven alpha numerical characters.

##### 9.2.3.1.5.2 PIN of SIM card

As a device operates via GSM network, SIM card is indispensable and it may be received from phone operator. Before the first use PIN code of SIM card shall be programmed for operation in given transmitter. PIN code is indispensable for automatic system launching. In case of card without PIN code, it is possible to enter any value e.g. 0000.

If you enter wrong PIN number after inserting card and switching on transmitter, the system will not launch and you may be able to use card after entering PUK card only (with use of any GSM mobile phone).

Factory setting of PIN in Active Track transmitter is 1111.

#### 9.2.3.2 Transmission

For the purpose of maximum security of transmission, data is encrypted with AES key. This option may be used for GPRS and SMS transmission. You may use your own code (256 bytes – signs 0-9 and A-F) or use default settings.

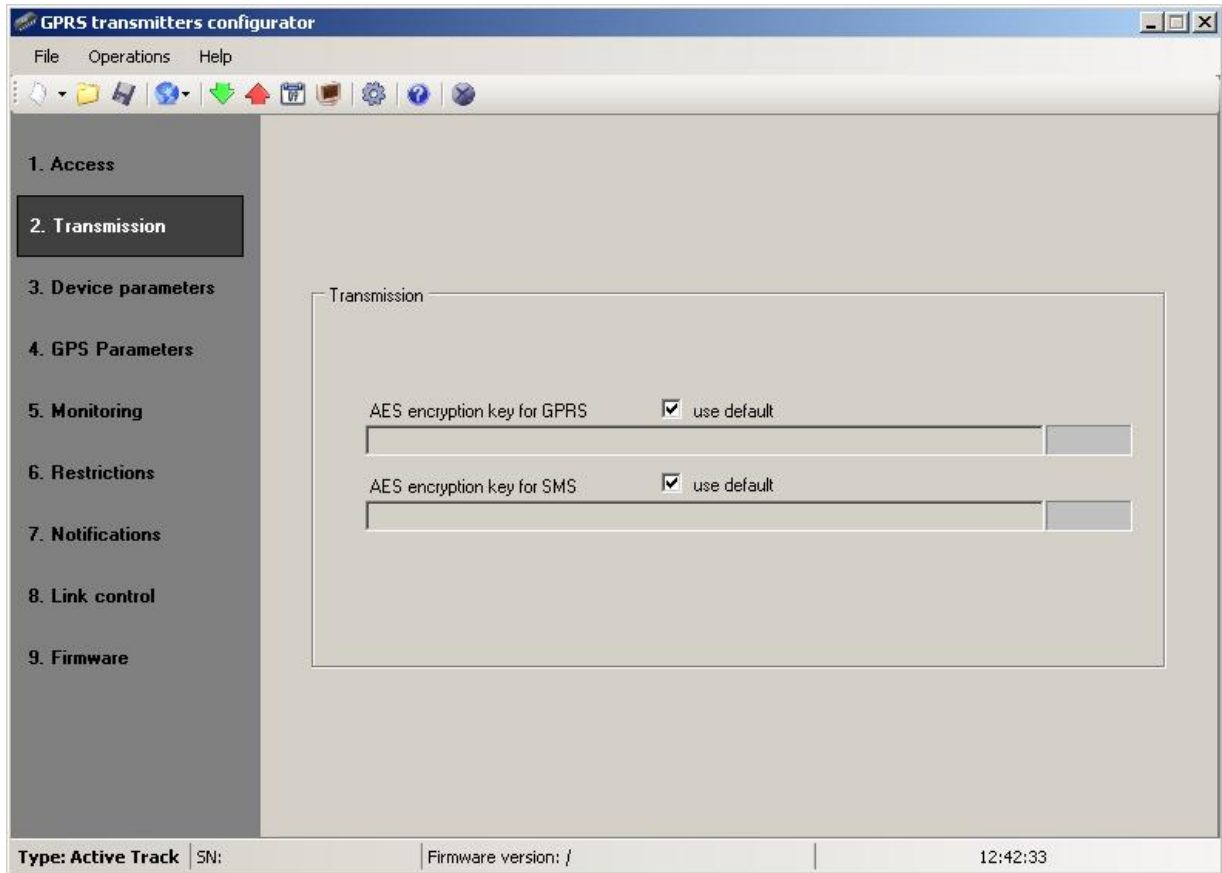

### 9.2.3.3 Device parameters

The Active Track device allows for configuring the accelerometer settings and the microphone and loudspeaker parameters. It is also possible to permit manual reset and turning off of the device by using an appropriate combination of buttons.

#### 9.2.3.3.1 Accelerometer

Thanks to built-in motion sensor it is possible to detect emergencies such as lack of guard's motion resulting from assault, or device's improper position against the axis of Earth's gravitational field. Way to send to the server events generated by the accelerometer features of the standard procedure shall be configurable in the Monitoring tab. Using the link "Check monitoring settings for ..." You can quickly verify the current settings for this procedure.



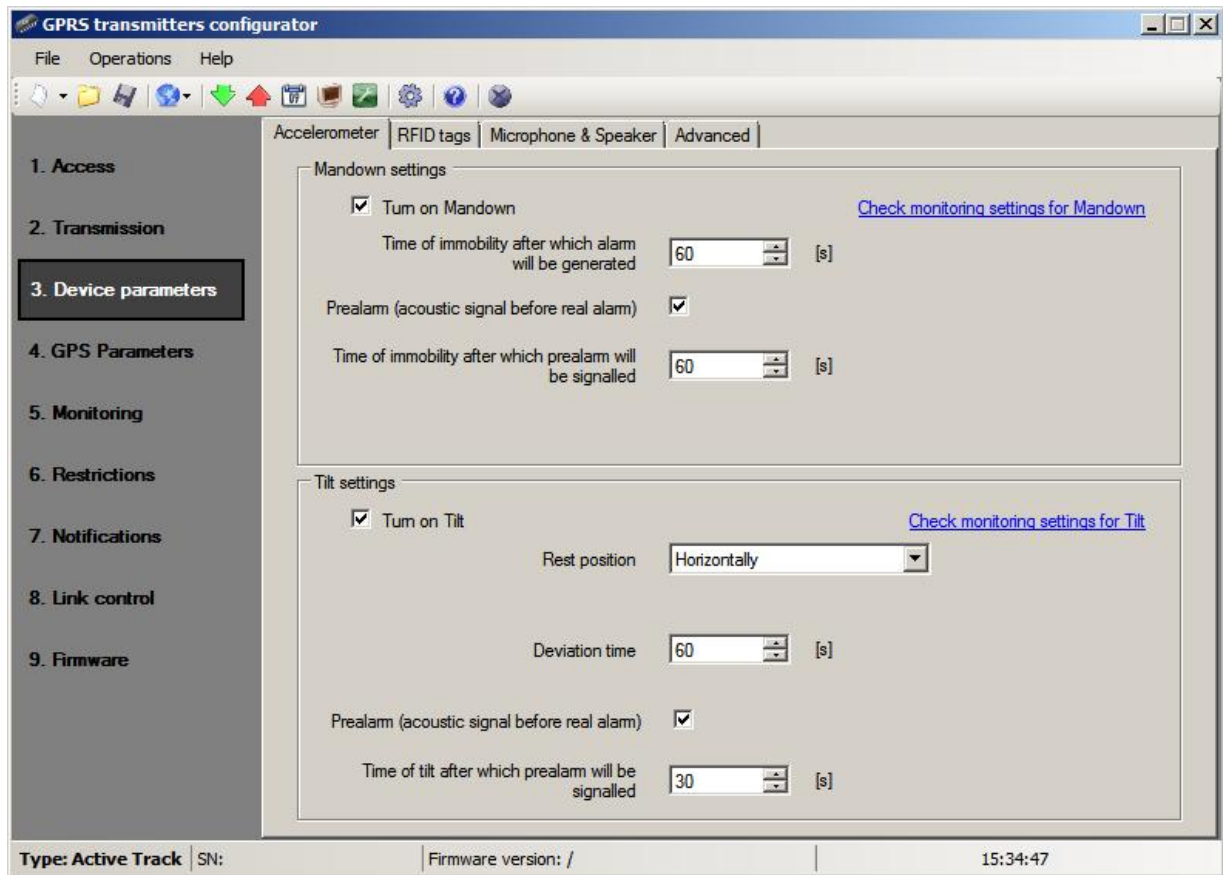

#### 9.2.3.3.1.1 ManDown

The ManDown functionality allows for monitoring and signalling motion of the guard holding the device. The lack of motion may result from an assault, but also from neglecting duties.

The adjustable parameters are:

- Sensitivity - specifying vibration threshold below which the device determines its state as lack of motion
- Time of immobility before the alarm - the time following which the device generates ManDown alarm in case of immobility
- Pre-alarm - functionality allowing the user to get information on detection of immobility before the ManDown alarm is generated
- Time of immobility before the pre-alarm generation - time after which the device in a static state signals immobility to the user

#### Note:

The method of pre-alarmed the device's user of the ManDown function activation (in other words: of the approaching generation of ManDown alarm) is described in point [Microphone & Speaker](#)<sup>44</sup>.

#### 9.2.3.3.1.2 Tilt detection

The device, thanks to the built-in motion sensor, can detect and signal its incorrect rest position. The functionality may be useful in transport, if a correct position of the package is required throughout the way. In such case it is enough to properly configure the device and firmly attach it in a correct position inside the package.

The adjustable parameters are:

- Rest position – defined neutral position of the device
- Tilt – threshold of deviation (in degrees) from any of the device's axes, above which it determines deviation from the rest position
- Tilt time - time following which the device which deviated from the rest position generates the Tilt alarm
- Pre-alarm - functionality allowing the user to get information on detection of deviation before the Tilt alarm is generated
- Time of tilt before the pre-alarm generation - time, after which the device signals detected deviation to the user

**Note:**

The method of pre-alarmed the device's user of the Tilt function activation (in other words: of the approaching generation of Tilt alarm) is described in point [Microphone & Speaker](#)<sup>[44]</sup>.

#### 9.2.3.3.2 RFID tags

The RFID tags tab allows for configuring multiple read-outs of RFID points by the Active Track device.

Tab is active only for device version with built in RFID transponders reader.

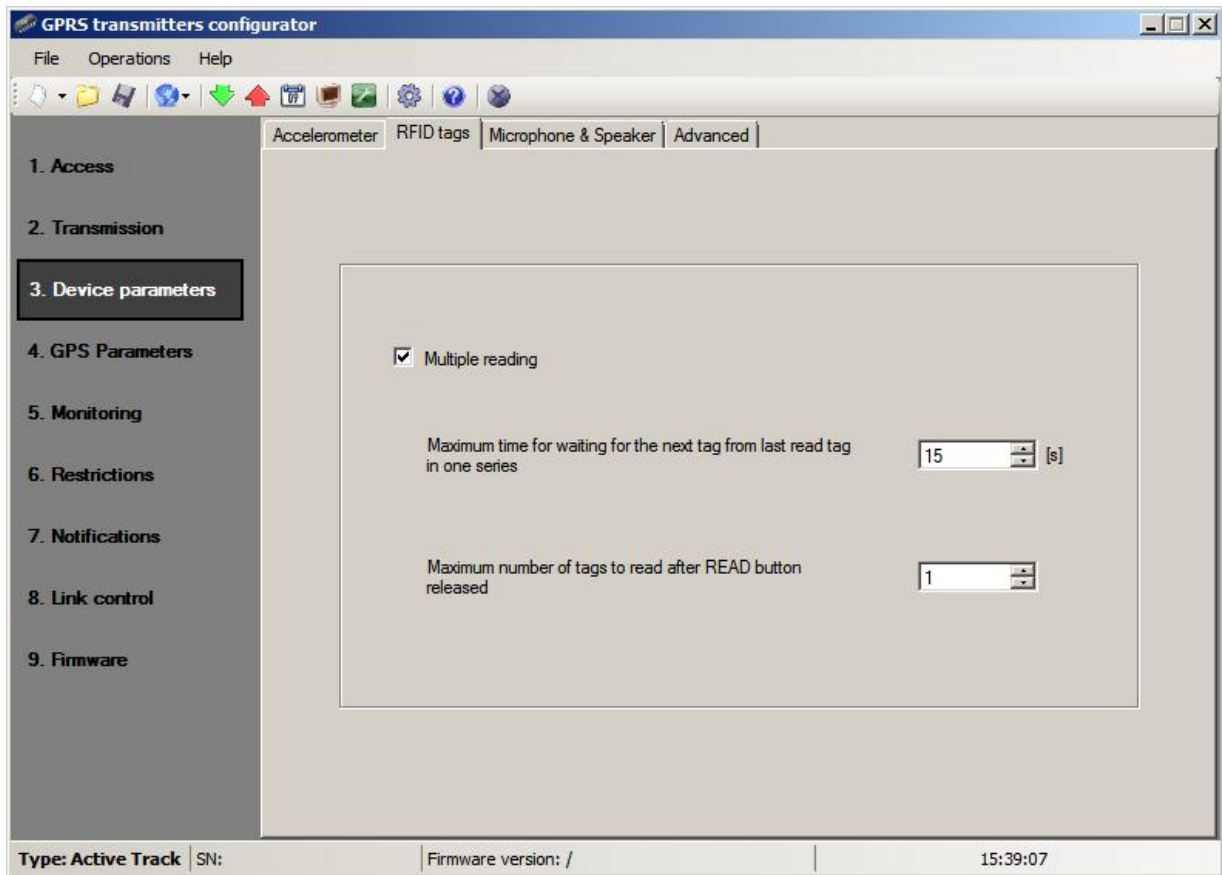

#### 9.2.3.3.2.1 Maximum time..

Determines the time the device waits to read out the next point from a given session after the previous read-out.

#### 9.2.3.3.2.2 Maximum number of tags...

Determines the number of RFID TAGs the user can be read in one session.

### 9.2.3.3.3 Microphone & Speaker

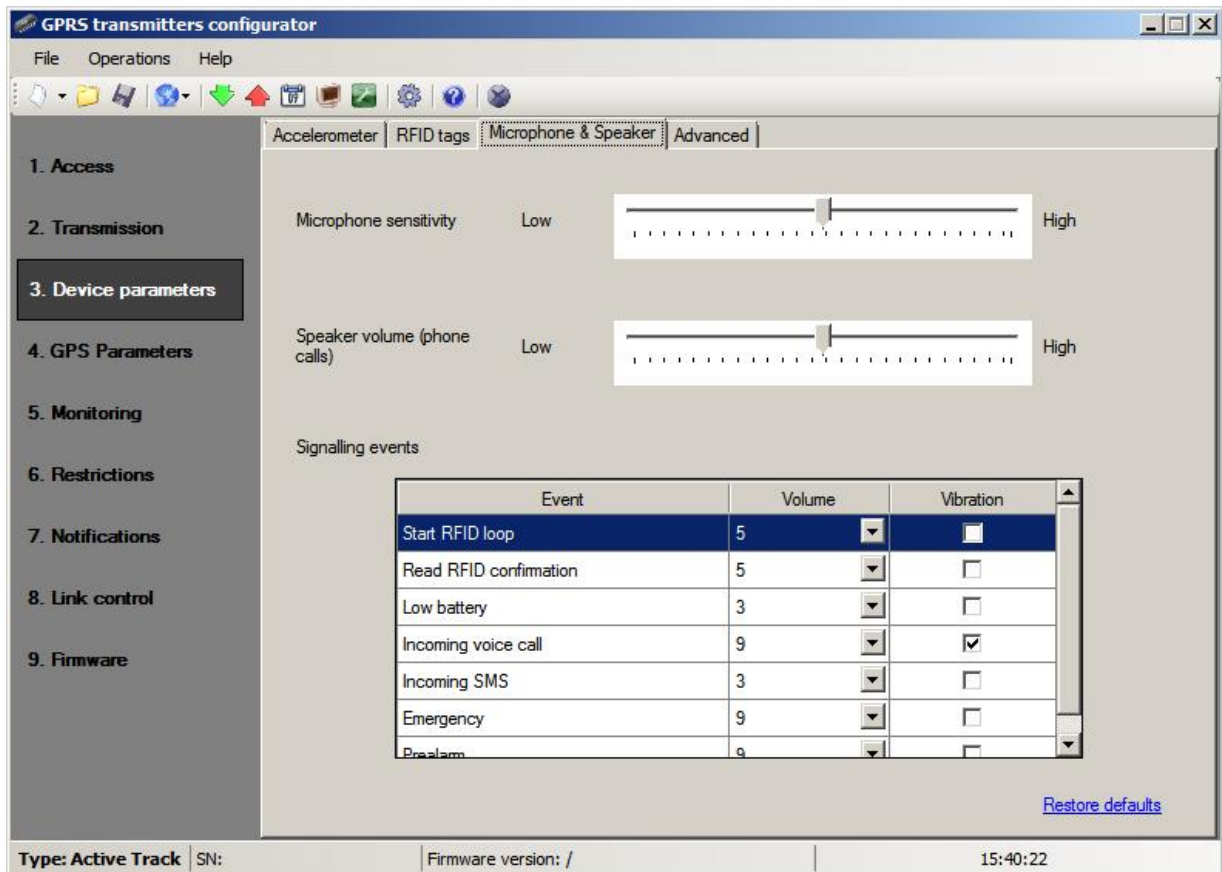

#### 9.2.3.3.3.1 Microphone sensitivity

Adjustments made to this parameter allow for setting the sensitivity of ambient sounds picked up by the microphone of the Active Track device during a telephone conversation.

#### 9.2.3.3.3.2 Speaker volume

Adjustments made to this parameter allow for specifying the sound volume of conversations.

#### 9.2.3.3.3.3 Events signalling

The list allows for specifying sound volume and vibration parameters.

There are 10 levels of sound volume for the events listed below, and it is also possible to turn on vibrations for some of them.

- Start RFID loop
- Read RFID confirmation
- Battery discharged
- Incoming voice call
- Incoming SMS message

- Outgoing call signalling
- Signalling pre-alarm

#### 9.2.3.3.3.4 Restore defaults

"Restore defaults" link restores the default settings for the microphone sensitivity, speaker volume, and way of signaling events.

#### 9.2.3.3.4 Advanced

The Advanced tab allows you to add permission to reset and / or turn off the Active Track device with the appropriate combinations of buttons.

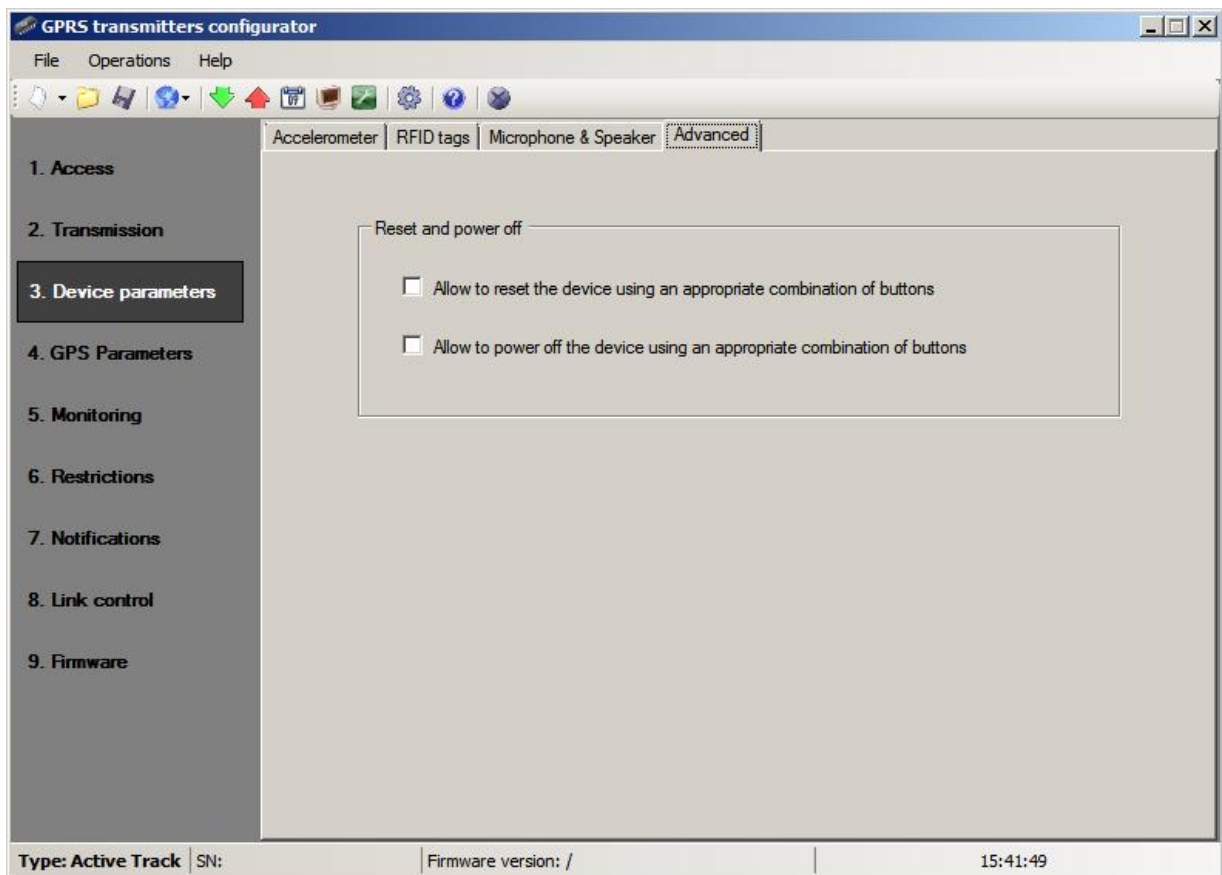

If you select "Allow to..." it is possible to reset the device or turn it off using a combination of buttons as described in chapter [Reset and turn off](#)<sup>67</sup>.

#### Note:

Manual reset and turning off the device events are recorded and transmitted to the supervising software after turning the device on and re-establishment of communication link.

### 9.2.3.4 GPS parameters

We can define in this tab the main parameters on which generating events LOCATION UPDATE will depend. The event will be sent to the server, provided that in the [Monitoring](#) <sup>47</sup> tab you activate them as reported. Furthermore, if in the additional information tab for the other events GPS position is select, along with the event will be transmitted location information. To generate this event it is necessary to fulfill at least one of the following conditions.

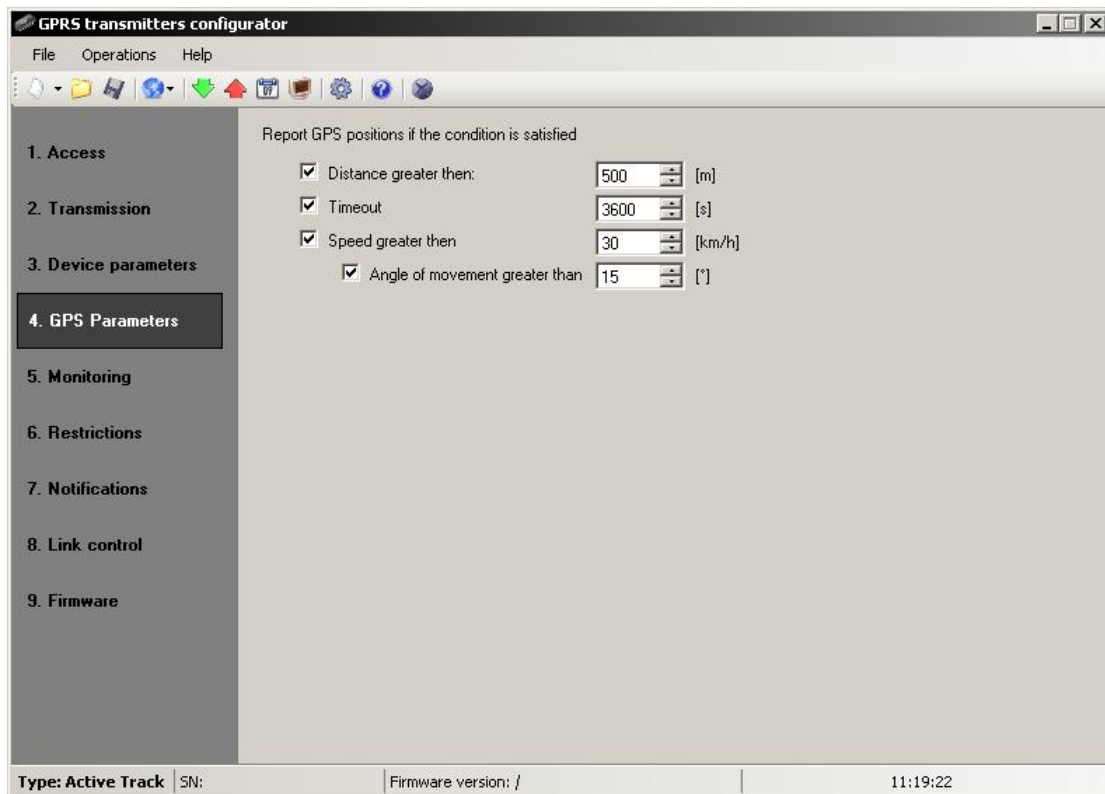

#### 9.2.3.4.1 Distance

If you select the option "distance greater than" the device will generate an event LOCATION UPDATE after having moved defined distance in meters from the last event, no matter which of the conditions generated the event.

#### 9.2.3.4.2 Timeout

If you select an option "Time" the device will generate an event LOCATION UPDATE counted after a specified time in seconds since the last event, no matter which of the conditions generated the event.

### 9.2.3.4.3 Speed and angle

If you want the device to generate an additional LOCATION UPDATE event when changing the direction of movement (degrees) when the device is moving we must also specify a limit on what speed (km / h) above this condition should be checked.

## 9.2.3.5 Monitoring

### 9.2.3.5.1 Events

Thanks to this option you may determine which of available signals generated by the device shall be transmitted to monitoring station.

The screenshot shows the 'GPRS transmitters configurator' window. The 'Events' tab is active, displaying a table with columns for Event, GPRS On, SMS On, On priority, GPRS Off, SMS Off, and Off priority. The 'Monitoring' section in the left sidebar is selected.

Event	GPRS On	SMS On	On priority	GPRS Off	SMS Off	Off priority
Panic	<input checked="" type="checkbox"/>	<input checked="" type="checkbox"/>	<input checked="" type="checkbox"/>			
CallMe	<input checked="" type="checkbox"/>	<input checked="" type="checkbox"/>	<input checked="" type="checkbox"/>			
Tamper	<input checked="" type="checkbox"/>	<input checked="" type="checkbox"/>	<input type="checkbox"/>	<input checked="" type="checkbox"/>	<input type="checkbox"/>	<input type="checkbox"/>
RFID tag read	<input checked="" type="checkbox"/>	<input type="checkbox"/>	<input type="checkbox"/>			
RFID / Checkpoint	<input type="checkbox"/>	<input type="checkbox"/>	<input type="checkbox"/>			
GPS Button	<input checked="" type="checkbox"/>	<input checked="" type="checkbox"/>	<input checked="" type="checkbox"/>			
Mandown	<input checked="" type="checkbox"/>	<input type="checkbox"/>	<input type="checkbox"/>	<input checked="" type="checkbox"/>	<input type="checkbox"/>	<input type="checkbox"/>
Tilt	<input checked="" type="checkbox"/>	<input type="checkbox"/>	<input type="checkbox"/>	<input checked="" type="checkbox"/>	<input type="checkbox"/>	<input type="checkbox"/>
Shock	<input checked="" type="checkbox"/>	<input type="checkbox"/>	<input type="checkbox"/>			
Low battery	<input checked="" type="checkbox"/>	<input type="checkbox"/>	<input type="checkbox"/>	<input checked="" type="checkbox"/>	<input type="checkbox"/>	<input type="checkbox"/>
Very low battery	<input checked="" type="checkbox"/>	<input type="checkbox"/>	<input type="checkbox"/>	<input checked="" type="checkbox"/>	<input type="checkbox"/>	<input type="checkbox"/>
Charging	<input type="checkbox"/>	<input type="checkbox"/>	<input type="checkbox"/>	<input type="checkbox"/>	<input type="checkbox"/>	<input type="checkbox"/>
SMS limit begin	<input type="checkbox"/>	<input type="checkbox"/>	<input type="checkbox"/>	<input type="checkbox"/>	<input type="checkbox"/>	<input type="checkbox"/>
Configuration changed	<input type="checkbox"/>	<input type="checkbox"/>	<input type="checkbox"/>			
CLIP	<input type="checkbox"/>	<input type="checkbox"/>	<input type="checkbox"/>			
Outgoing voice call	<input checked="" type="checkbox"/>	<input type="checkbox"/>	<input type="checkbox"/>	<input checked="" type="checkbox"/>	<input type="checkbox"/>	<input type="checkbox"/>

Buttons at the bottom of the table: [Restore defaults](#), Invert, Clear, Clear, Invert, Clear, Clear.

Footer: Type: Active Track | SN: | Firmware version: / | 15:44:03

Using the "Restore defaults" link it is possible to return to the manufacturer's recommended settings, how to send events to the supervisory software.

**Note:**

"Configuration changed" event refer to configuration changes made by SMS or GPRS commands.

#### 9.2.3.5.1.1 GPRS On / GPRS Off

In this column you define signals that are to be reported to monitoring station with GPRS transmission. There is possibility to send information for alarms (e.g. the "Panic" button being pushed) as well as in some cases for return to normal state (e.g. turning off the sabotage switch).

To transmit any signal you should only click it (proper square on your right).

Click on [Clear] button to remove all marked signals.

Click on [Invert] button to change markings to contrary.

#### 9.2.3.5.1.2 SMS On / SMS Off

In this column you define signals that may be reported at monitoring station with SMS messages – when there is no connection with server over GPRS. There is possibility to send information for alarms (e.g. the "Panic" button being pushed) as well as in some cases for return to normal state (e.g. turning off the sabotage switch).

To transmit any signal you should only click it (proper square on your right).

Click on [Clear] button to remove all marked signals.

Click on [Invert] button to change markings to contrary.

#### 9.2.3.5.1.3 On priority / Off priority

These columns define which signals are to be reported to the monitoring station as first. A priority can be set both for alarms (e.g. the "Panic" button being pushed) as well as in some cases for return to normal state (e.g. turning off the sabotage switch).

Pressing the [Clear] button deletes all the criteria marked in a given column.

#### 9.2.3.5.2 Additional data

The Additional data functionality allows for defining kinds of additional data which will be transmitted together with events to monitoring station via GPRS/SMS. The data may become valuable information about device's work conditions though it may increase amount of bytes sent through GSM network. It is possible to define two separate sets of additional data kinds: for test events (sent periodically according to setting on [Access](#)<sup>35</sup> tab) and for other events. Put a mark next to the name of data kind to turn on transmission of this data kind to monitoring station. Empty field means that this kind of data will be not transmitted.



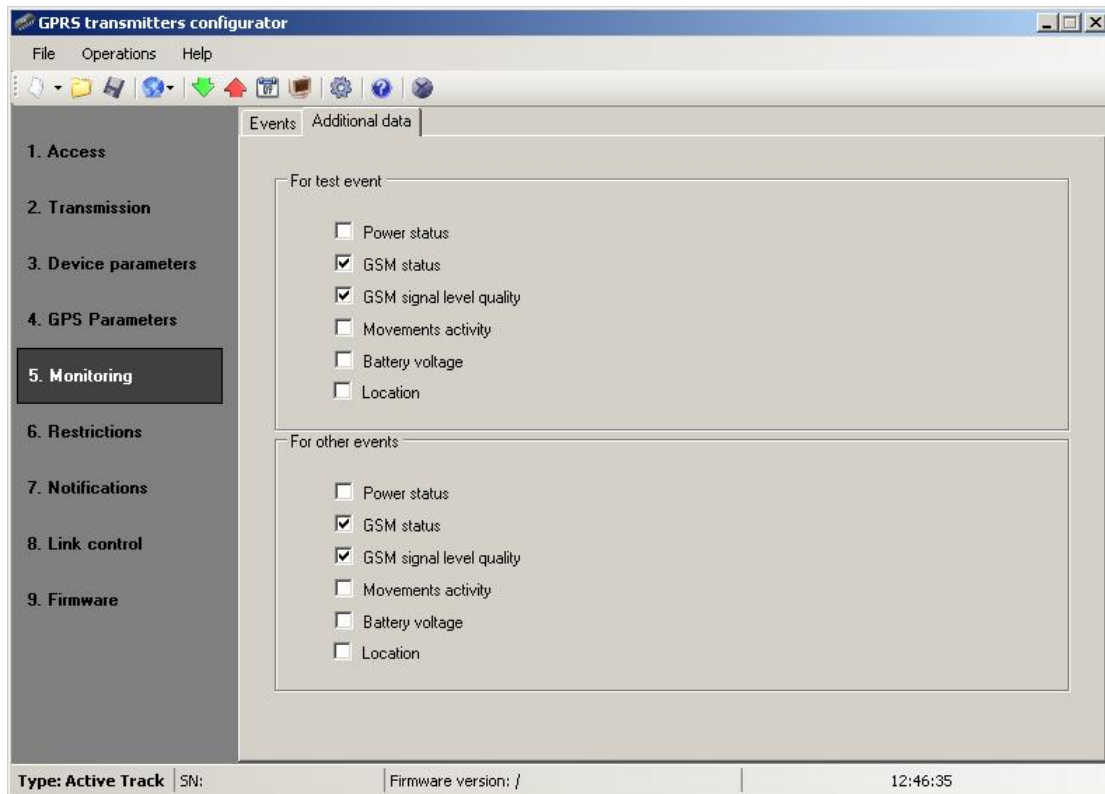

The adjustable parameters are:

- Power status - information about connected charger and battery charging
- GSM status - status about connection to GSM network, type of connection to server (GPRS/SMS), information about ongoing phone calls
- GSM signal level quality - quality of connection to GSM network (CSQ and BER parameters)
- Movements activity - movements activity read out from accelerometer
- Battery voltage - voltage of battery in millivolt unit
- Location - detailed information about location from GPS module

### 9.2.3.6 Restrictions

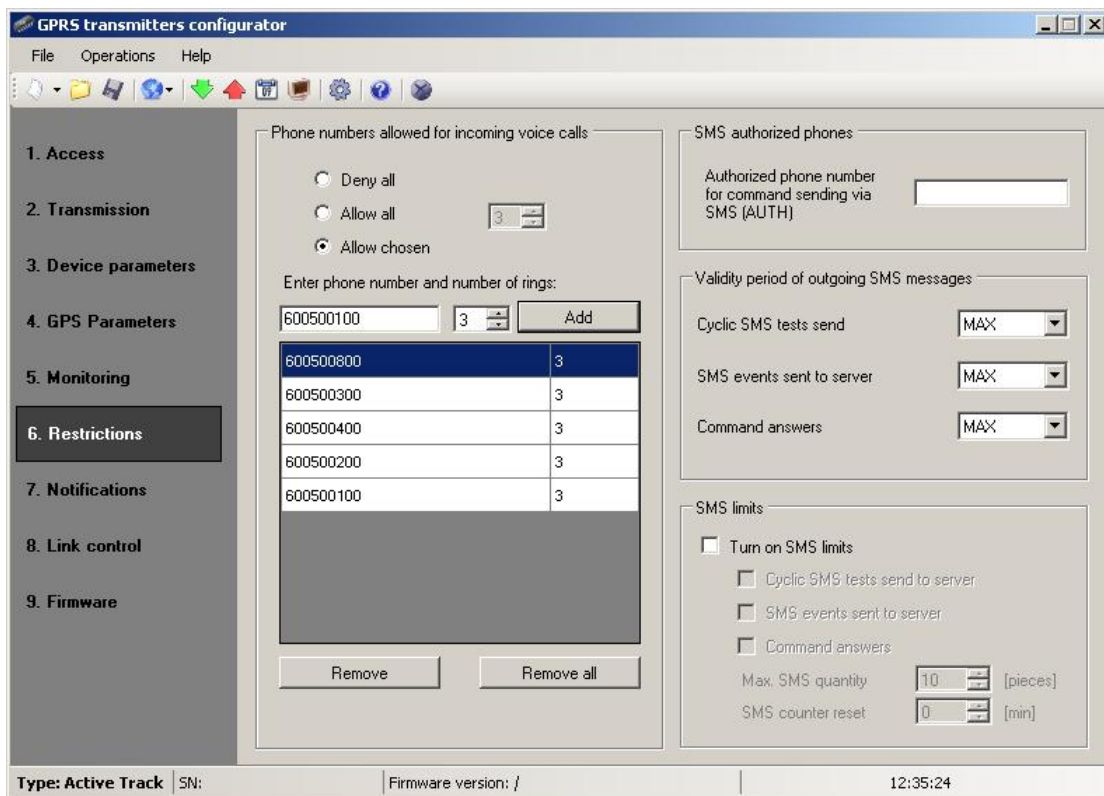

#### 9.2.3.6.1 Phone numbers...

The user can specify here the phone numbers for incoming calls to be automatically answered by the Active Track, as well as the number of rings.

- Decline all: No connection possible.
- Allow all: Connection possible from any phone number.
- Allow selected: Connection possible only from the phone numbers on the list. Up to 8 numbers can be defined.

The edit box becomes active after choosing Allow selected. The subsequent numbers entered into the field can be added to the table below by clicking the [Add] button. Placing the cursor in a selected line containing the number and clicking "Delete" removes the number from the table.

The "Delete all" option removes the content of the whole table.

#### Note:

Authorization of incoming call consists of comparing the number with that on the list. It is possible to put only a fragment of the number on the list, e.g. 1234. Authorized then are all numbers containing the sequence, e.g. 600**1234**56 or 60**1234**567.

#### 9.2.3.6.2 SMS authorized phones

The user can specify the phone number authorized to send configuration SMS to the Active Track device.

**Note:**

- a) Authorization of the incoming configuration SMS consists of comparing the number with that in the number field. It is possible to put only a fragment of a number in the number field, e.g. 1234. Authorized then are all numbers containing the sequence, e.g. 600**1234**56 or 60**1234**567.
- b) If SMS is sent via the OSM.2007 server's modem, its phone number (or at least part of it – according to the previous remark) has to be entered into the aforementioned field.

#### 9.2.3.6.3 Validity period of outgoing SMS messages

User may limit time for the GSM operator to deliver information via SMS when recipient is unavailable due to out of GSM signal coverage for example. Time limit is defined separately for the following groups of information:

- SMS test to server
- SMS events sent to server
- Answers to comments

Selection is to be made from scrolled down values by clicking on arrow besides selection area. Allowable options: 5, 10,15, 30 minutes; 1,2,6, 12 hours; 1, 7 days, MAX (meaning no specified time).

#### 9.2.3.6.4 SMS limits

User may limit number of SMS sending by transmitter. As the main way of transmission should be GPRS this limitation is essential to reduce costs.

Mark field [Turn on SMS limits] to activate access to information groups that shall subject to limitation:

- SMS test to server
- SMS event s sent to server
- Answers to comments

Limitation are defined by providing two values:

- SMS maximum number: determines maximum number of sent SMS messages per time unit (see SMS counter reset). This option protects user against sending too much of SMS messages e.g. in case of failure.
- SMS counter reset: This parameter determines time schedule (in minutes) according to which counter of sent SMS messages will be zeroed

## 9.2.3.7 Notifications

### 9.2.3.7.1 Phone numbers

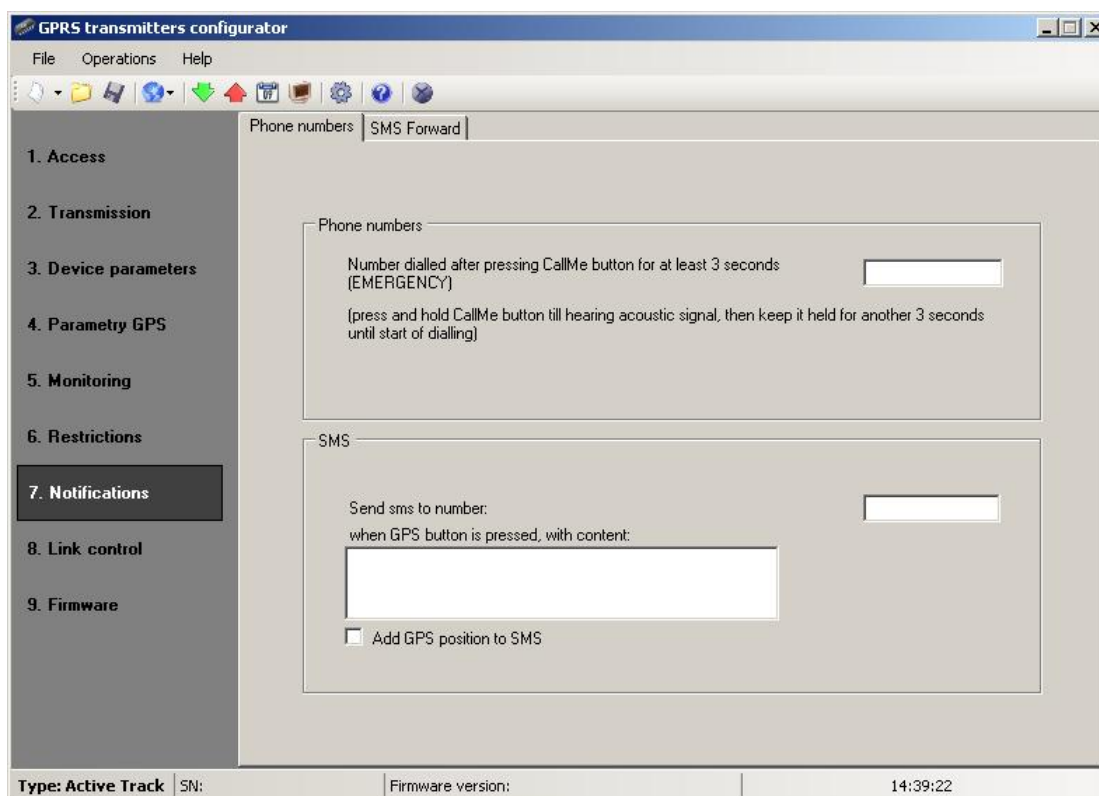

The user can define here:

- an EMERGENCY phone number for outgoing call, activated by holding down the CallMe button (see chapter [Outgoing voice call](#) <sup>[66]</sup>)

**Note:**

This is usually 112 or the Police phone number. It is, however, possible to enter here any phone number in the format defined by the GSM network operator whose SIM card is installed in the device.

- SMS - phone number, message and checkbox for sending location for emergency SMS activated by holding GPS button

### 9.2.3.7.2 SMS Forward

The device is able to forward received SMS messages according to the specified rules. This function may be helpful when GSM operator sends messages with account state to SIM card installed within device. In this window you may provide up to 5 rules.

Each rule contains a pair: part of sender phone number and correct recipient phone number. In some cases a part of sender phone number may be an empty string which means that any phone number matches to the rule. All rules are processed with given order. It means that in some cases one SMS message may be forwarded to more than one recipients and/or some of them may be forwarded more than once to the same recipient. The second case may occur when there are at least two rules with the same recipient phone number and their part of sender phone number matches with message sender phone number.

**Note:**

It is a user's responsibility to provide correct rules which will not create loops of forwarded SMS messages.

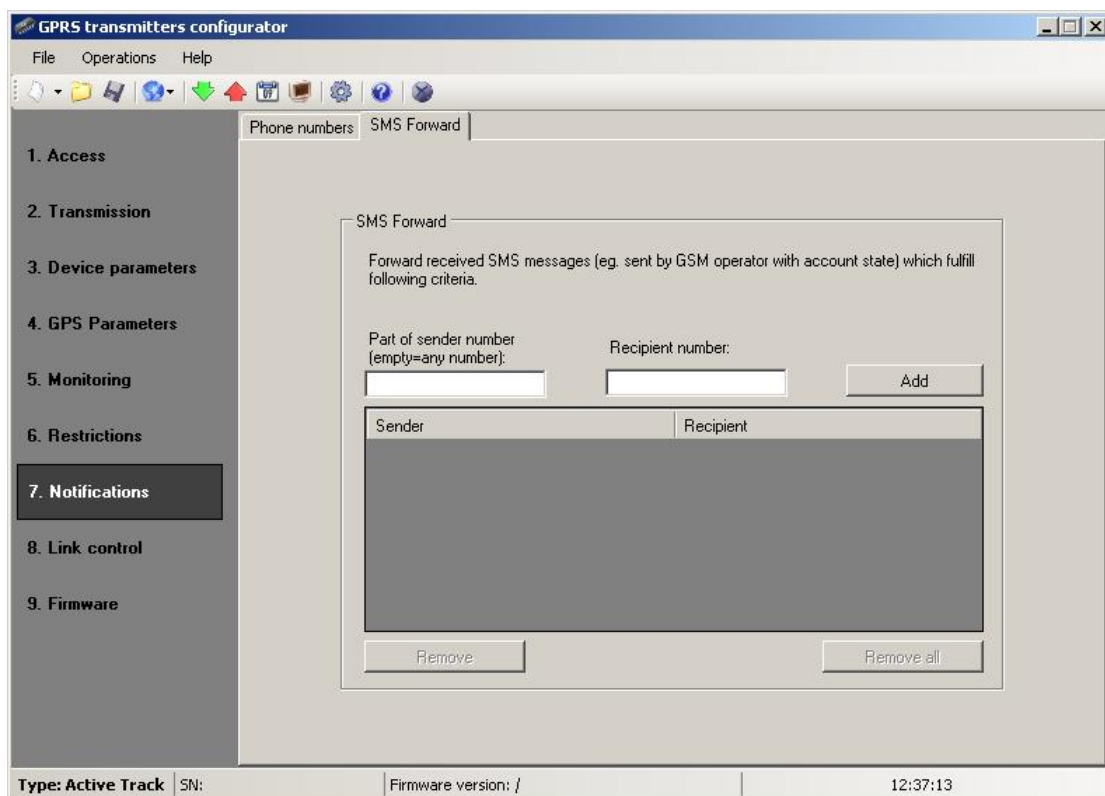

### 9.2.3.8 Link control

These options enable automatic action of device if communication with monitoring station was broken up. It relates to situations when device lost connection to GSM network or if GPRS transmission is impossible.

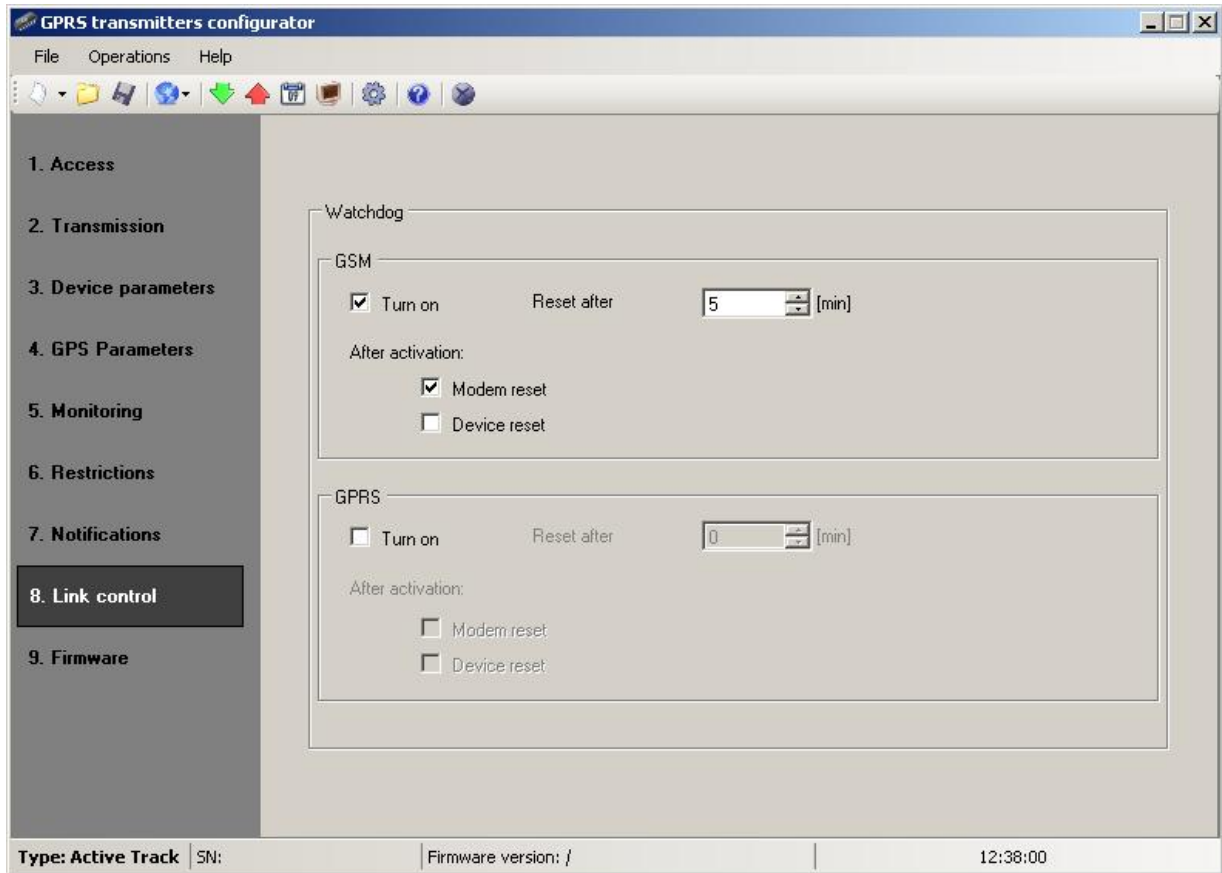

#### 9.2.3.8.1 GSM

Activate this function (mark [Turn On] field) to get access to parameters determining action of device if outside GSM network.

Define time limit after which transmitter shall reconnect to network. Enter time limit in field [Reset after] and provide this value in minutes.

Next define action that the device shall perform. Select action by marking proper square next action description:

- Modem Reset
- Device Reset

In case of no connection with GSM network the device after recognizing the situation shall wait during provided time limit and then shall perform programmed actions.

#### 9.2.3.8.2 GPRS

Activate this function to (mark [Turn On] field) to get access to parameters determining action of device if GPRS connections is lost.

Define time limit after which transmitter shall reconnect to network. Enter time limit in field [Reset after] and provide this value in minutes.

Next define action that the device shall perform. Select action by marking proper square next action description:

- Modem Reset
- Device Reset

In case of no connection with GPRS network the device after recognizing the situation shall wait during provided time limit and then shall perform programmed actions.

### 9.2.3.9 Firmware

The device is equipped with built in bootloader that allow for updating and change of firmware. During programming all information is displayed in respect of carried out operation.

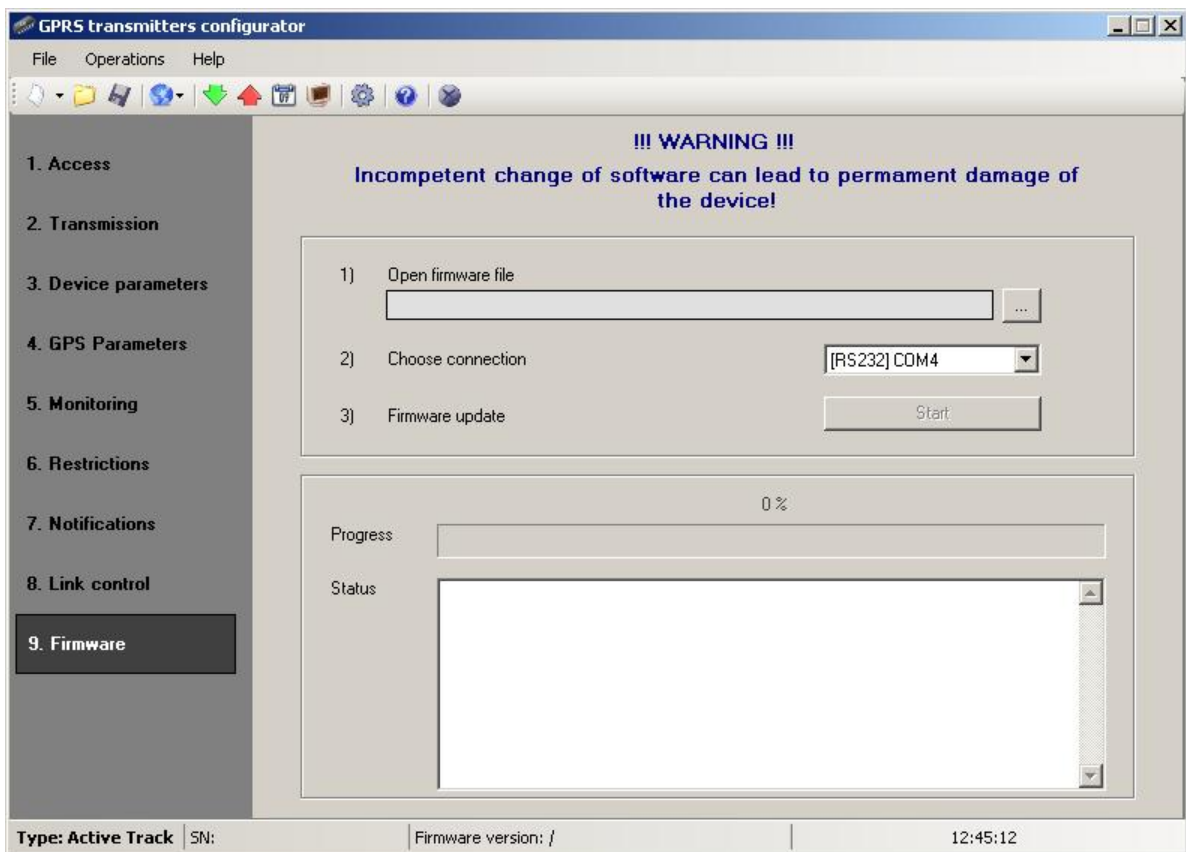

Follow the procedure:

- a) Launch configuration program
- b) Open "Firmware" option of configuration wizard
- c) Open file with new firmware (click [Open] button to locate where file is).
- d) Select file transmission mode: local or remote.

**Note:**

Procedure of assigning firmware to a device is analogous to programming a

device. For procedure refer to chapter [Device programming](#)<sup>56</sup>.

- e) Click [Start] button to start software exchange.
- f) Loading course is displayed on special window.
- g) Close the window after completed saving

From this time on the device will work under control of new firmware.

**Note:**

**The above procedure shall be carry out with due care to avoid improper device operation.**

## 9.2.4 Device programming

Programming of device is possible with "GPRS transmitters configurator" configuration program described in chapter [Configuration program](#)<sup>27</sup>. To program the device establish connection with a device.

Depending on connection mode there are two ways for programming.

### 9.2.4.1 Programming adapter and cable

In order to gain access to device's programming functions via RS232 port special programming adapter (AGP3) and cable (LX-PROG or LX-DATA) is necessary. Adapter is equipped with two connectors: PROG and MODEM. The first one is used for local programming, controlling device's state (Device Monitor) and reading device's event history. The second connector may be used for GSM modem work auditing.

Below is a summary of AGP3 adapter and cables application:

	<b>AGP3</b>	<b>LX-PROG</b>	<b>LX-DATA</b>
Device programming	●	●	○
Firmware update	●	●	○
Events history	●	●	○
Device Monitor	●	○	●

### 9.2.4.2 Local programming

To program a device locally follow the procedure:

- a) Turn the device upside down, open lid by unscrewing bolts and take it off. Remove battery from cavity (don't disconnect it!) and fasten AGP3 adapter in a socket located near SIM card holder.
- b) Connect PROG joint (on AGP3 adapter) with COM computer port by way of service wire, defined in option Connections -> RS-232.
- c) After connection and detection of programming wire a module shall signal this



- with LED diodes: an orange one shall flash and red one shall flicker.
- d) Launch software and define device options (description is in chapter [Programmable parameters](#)<sup>[35]</sup>). Provide right PIN code for SIM card.
  - e) Save settings into memory of device. Saving course is displayed in special window.

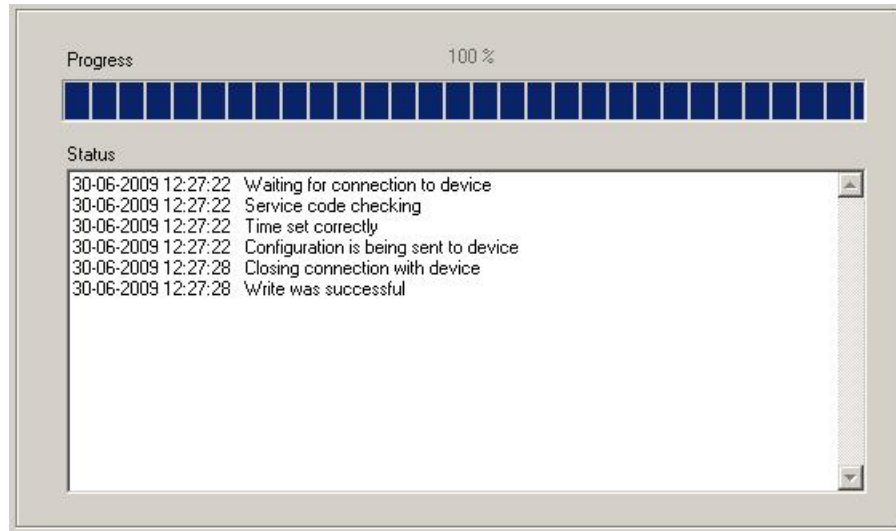

- f) After saving insert SIM card, disassembly AGP3 adapter and service wire.
- g) Put battery into cavity, lay down wires and close lid by screwing bolts according to chapter [SIM card and battery installation](#)<sup>[17]</sup>.
- h) The device is ready to transmit data.

### 9.2.4.3 Remote programming

Remote programming of device is possible if:

- user uses GPRS transmitters configurator and GSM modem connected to PC
- user uses OSM.2007 monitoring system receiver.

In first case remote programming is possible on CSD channel and its procedure is analogous to local programming, remembering that "Modem GSM" shall be selected from connection options (See chapter [CSD linking](#)<sup>[31]</sup>).

#### **Note:**

Remote configuration with use of CSD canal is possible only if transmission of CSD data is active both for SIM card inserted in the device, and for SIM card installed in GSM modem.

In second case according to description in chapter [GPRS linking](#)<sup>[30]</sup>, it is required to define remote link on grounds of OSM.2007 parameters. As OSM.2007 collects (and transmits) information exclusively from devices saved in data base, the first operation during remote programming is proper registration of the device. This procedure has been described in OSM.2007 Operation Manual.

#### 9.2.4.3.1 The first programming of device

As the device does not have defined access parameters in respect of GPRS network and OSM.2007, programming shall be begun with providing parameters defined in chapter [Programmable parameters](#)<sup>[35]</sup>. After providing these parameters register the device in OSM.2007 data base (see OSM.2007 manual).

Before remote programming user shall check that the device is furnished with SIM card (with reservations provided in chapter [PIN code](#)<sup>[11]</sup>) and is connected to power supply. User shall know serial number of device and phone number for SIM card.

Follow the procedure:

- a) With the use of OSM.2007 console position cursor on proper device in "Devices" tab (**make sure that OSM.2007 has proper device's access code entered!**).
- b) Click "Config." option and then select "Set Configuration" function to display list of parameters.
- c) Enter server address, server port and APN. Click OK and system shall send to device provided parameters (SMS).
- d) Wait till device addresses server (in "Devices" tab it will be marked with green colour).
- e) Launch software and define options of device (description is provided in chapter [Programmable parameters](#)<sup>[35]</sup>).
- f) Select "Send" to display a new window and select remote connection (GPRS tab). Save settings in memory of device. Saving course is displayed on special window.
- g) After saving completion close Configuration Wizard.
- h) The device is ready to transmit data.

#### 9.2.4.3.2 Reprogramming of device

As the device has defined access parameters in respect of GPRS network and OSM.2007, it is possible to program device at any time.

If device is installed in secured object and is furnished with SIM card and connected to power supply follow the procedure:

- a) Launch configuration wizard and define options of device (description is provided in chapter [Programmable parameters](#)<sup>[35]</sup>).
- b) Select "Send" to display a new window and select remote connection (GPRS tab). Save settings in memory of device. Saving course is displayed in special window.

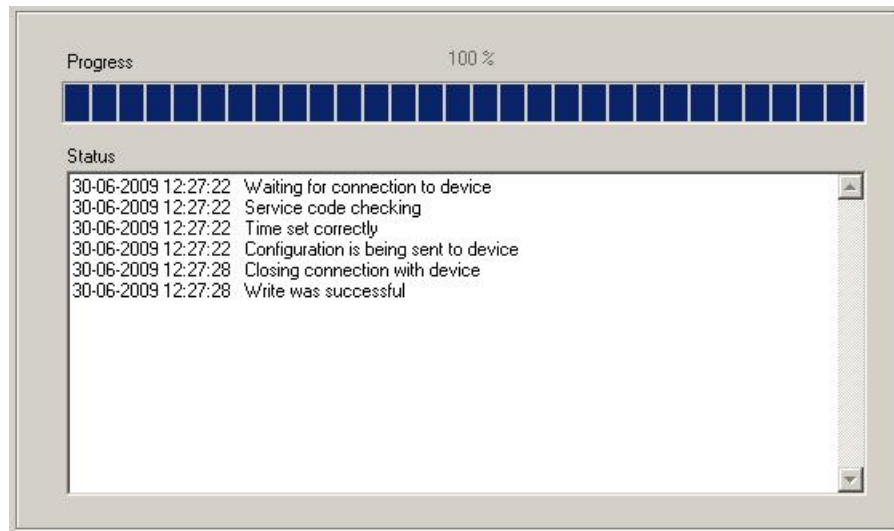

- c) After saving completion close Configuration Wizard
- d) The device is ready to transmit data according to new settings.

## 9.2.5 Device Monitor

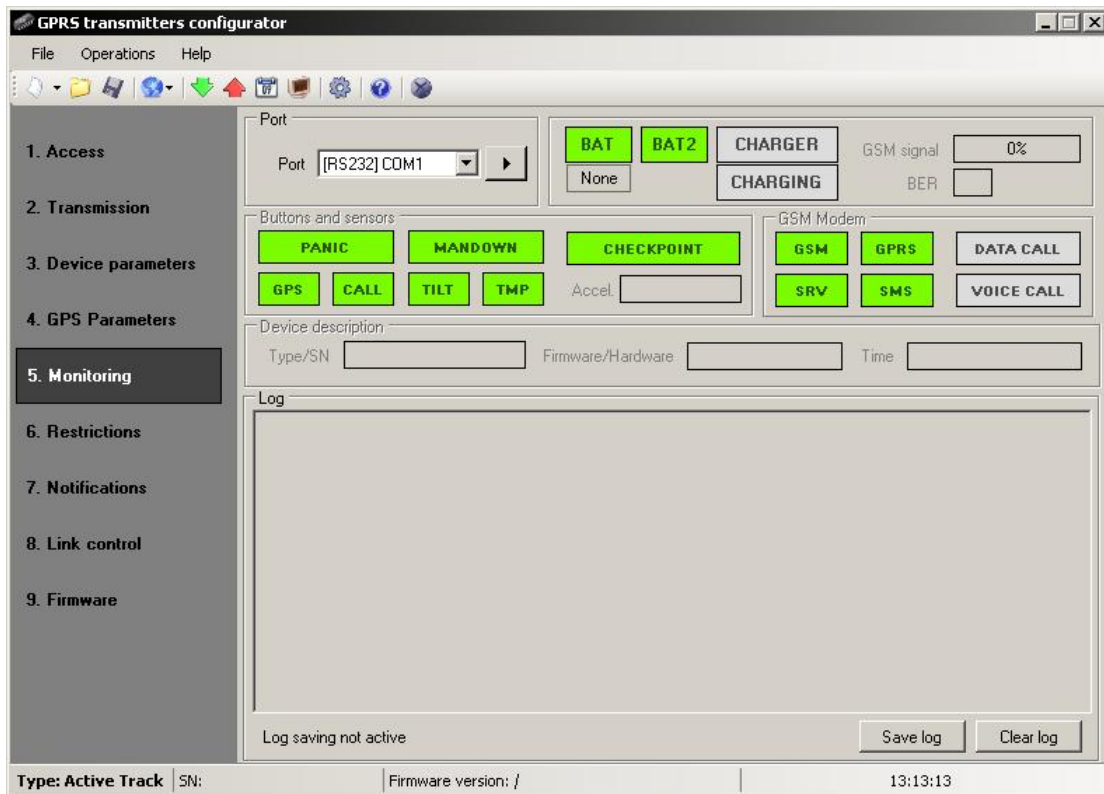

“Device Monitor” provides real-time information on Active Track device state. To use this function Active Track must be connected to PC computer with LX-DATA cable (using DEBUG plug). Correct RS232 port must be chosen in “Port” field. “Device monitor” provides following information:

- Battery power indication
- Charger and charging indicators
- GSM network signal level indication
- Bit-Error-Rate level measuring
- Inputs and motion sensor state monitoring
- Ongoing voice and data call indicators
- Type or serial number of device
- Firmware and hardware revision
- Device time

These parameters are also shown in LOG window in text style. All data can be saved to file.

## 9.2.6 Events history

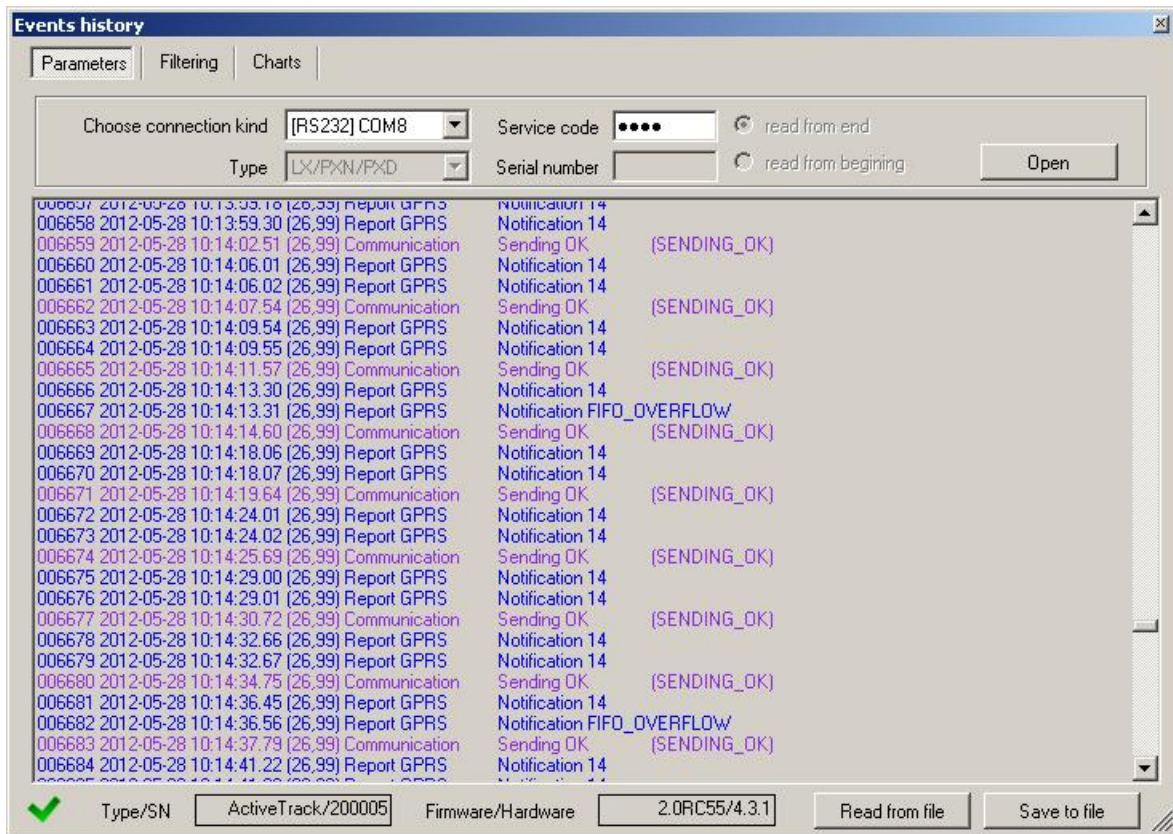

„Events history“ provides information about last events stored in Active Track device memory. Active Track is able to save 192kB of data, which is about 8000 events. It is possible to read the history of both using a GPRS connection and RS232. In the second case data can be send to PC only via LX-PROG cable (the white one). Correct RS232 port or GPRS connection must be chosen in “Choose connection kind” field. After providing Service code and clicking “Open” button events data will be downloaded from Active Track memory. After properly reading access to features such as the "Filtering" and "Charts" becomes possible. Both of them may be used to quickly diagnose the device.

**Events history**

Parameters | **Filtering** | Charts

All events   
 Communication   
 Tests   
 Power   
 Logs and diagnostics  
 All reports   
 System   
 Connectivity   
 Malfunctions   

006836	2012-05-28 10:55:58.63 [16,99]	Communication	GPRS response sent (GPRS_SENT)
006837	2012-05-28 10:55:58.63 [16,99]	GPRS	'+CSQ: 18,99\n\nOK\n'
006838	2012-05-28 12:31:14.61 [19,99]	Event	Input on TMP
006839	2012-05-28 12:31:15.03 [19,99]	Report GPRS	Input on TMP
006840	2012-05-28 12:31:22.23 [19,99]	Communication	Sending OK (SENDING_OK)
006841	2012-05-28 12:40:05.94 [16,99]	Event	Input off TMP
006842	2012-05-28 12:40:06.03 [18,99]	Report GPRS	Input off TMP
006843	2012-05-28 12:40:06.21 [18,99]	Event	Input on TMP
006844	2012-05-28 12:40:07.77 [18,99]	Communication	Sending OK (SENDING_OK)
006845	2012-05-28 12:40:10.86 [18,99]	Report GPRS	Input on TMP
006846	2012-05-28 12:40:12.83 [18,99]	Communication	Sending OK (SENDING_OK)
006847	2012-05-28 12:40:27.54 [18,99]	Event	Input off TMP
006848	2012-05-28 12:40:27.88 [18,99]	State GENERAL	SIM ERROR 1 (SIM ERROR)
006849	2012-05-28 12:40:29.42 [18,99]	State GENERAL	SIM ERROR 0 (SIM ERROR)
006850	2012-05-28 12:40:29.42 [18,99]	Modem response	'\n\n+CME ERROR: 13\n\n'
006851	2012-05-28 12:40:29.54 [18,99]	Report GPRS	Input off TMP
006852	2012-05-28 12:41:14.81 [18,99]	Event	Input on TMP
006853	2012-05-28 12:41:30.07 [18,99]	Communication	Sending failed (SENDING_FAILURE)
006854	2012-05-28 12:41:30.07 [18,99]	Communication	Disconnected from server (SERVER_DISCONNECT)
006855	2012-05-28 12:41:30.19 [18,99]	Event	Bearer lost SERVER
006856	2012-05-28 12:41:30.19 [18,99]	Event	Bearer lost GPRS
006857	2012-05-28 12:41:30.20 [18,99]	Event	Bearer lost GSM
006858	2012-05-28 12:41:30.20 [18,99]	Event	Notification MODEM_RESET
006859	2012-05-28 12:41:53.76 [18,99]	State GENERAL	SERVICE CABLE BEGIN 0 (SERVICE CABLE BEGIN)
006860	2012-05-28 12:41:55.36 [18,99]	Event	Notification TIME_UPDATE
006861	2012-05-28 12:41:57.00 [18,99]	Event	Notification TIME_RESTORE
006862	2012-05-28 12:41:57.15 [18,99]	Event	Notification CONFIGURATION_CHANGED
006863	2012-05-28 12:42:23.04 [18,99]	State GENERAL	SERVICE CABLE END 0 (SERVICE CABLE END)

Type/SN    ActiveTrack/200005   
 Firmware/Hardware    2.0RC55/4.3.1

**Events history**

Parameters | Filtering | **Charts**

GSM signal   
 GSM connection   
 Mode: server   
 Voice call   
 Charger  
 Battery voltage   
 GPRS connection   
 Mode: SMS   
 CSD call   
 Charging   

**History states for the device ActiveTrack/200005**

GSM signal   
 Battery voltage

Type/SN    ActiveTrack/200005   
 Firmware/Hardware    2.0RC55/4.3.1

## 10 Controlling commands

---

Active Track can receive control messages through SMS messages or GPRS link (e.g. by using Console of monitoring receiver OSM.2007). These messages can enable additional functions of device or request additional information about device condition.

### **BEEP=f,d,n,v**

Generates acoustic signal with f frequency, d signal length (in multiply of 100ms), n repeats and v volume.

### **DISC**

Disconnects device from server.

### **FLUSH=x**

Clears the FIFO queue, where **x** means that the queues to be cleaned:

0 - the queue of outstanding events to be sent to the server

1 - events history (see [Events history](#) <sup>61</sup>)

Example: FLUSH=0

### **CONNECT**

Force immediately attempt of connection to server.

### **KILL**

Sending this command remotely resets the device.

### **CMD = AT\_command**

Sending it makes the device modem follow this command and return report of action result. Particular commands has been blocked due to safety reasons and would be reported as <blacklisted> if received.

Example:

CMD=AT+CSQ (enables remote reading of the device GSM signal level).

### **VER**

Sending this command makes the device send software version as a reply.

### **DESC**

Sending this command downloads the device description in Active Track v.VER

### **GETCFG**

Sending this command returns current device configuration. Parameters are returned in following style: SERVER:PORT APN UN PW SMS TPERIOD

**GET=[parameter names, separated by commas]**

Sending this command returns current value of given parameter (e.g. GET=SERVER,APN will return for example: 89.172.87.135 erainternet).

**LOCATION**

Sending this command makes the device send GPS location as a reply.

## 11 Operation rules

---

ACTIVE TRACK is an integrated, wireless device that allows location of the person or property. Unit has built in GPS receiver and a quad band GSM/GPRS module with phone function for two way communication.

This functional advanced device can be applied indoor and outdoor because of A-GPS service, that supports GPS signal from satellites by GSM/GPRS.

In an emergency situation you may send from the unit two types of signals: "Call" or "Attack".

Optional, device might be equipped built in RFID transponders reader.

### ■ RFID transponder read-out

Read-out RFID transponders manual applies only device with built in RFID transponders reader.

If you wish to read ID-Tag, label or RFID card, press "Read-out" button and within 15 seconds approach it with reading area (see [Functions review](#)<sup>[13]</sup>). In case of no read-out, the device returns to normal work mode after that time.

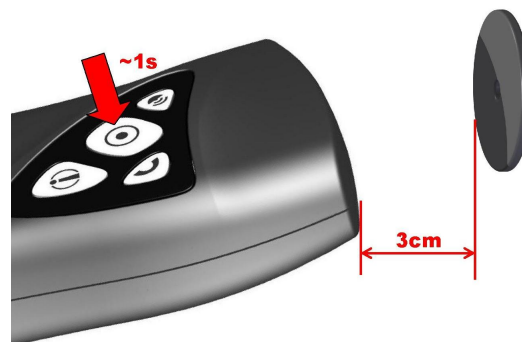

If option of several RFID tags read-out in one session is enabled (see RFID in chapters [Remote configuration](#)<sup>[21]</sup> and [RFID tags](#)<sup>[42]</sup>) procedure is following: after push of "Read-out" button first tag must be read in 15 seconds time. Next tags must be read in time period not longer than set in RFID parameter. The steps can be repeated until last RFID read-out.



For more information about expecting time for transponder and confirmation of correct read-out, go to [Indicating work mode](#)<sup>69</sup>.

### ■ Sending „Panic” command

In emergency, you may send “Panic” command to monitoring station by pressing “Panic” button.



### ■ Sending „Call me” command

In emergency, you may send “Call me” command to monitoring station. It means you expect operator to call you back.



### ■ Voice connection (incoming)

The device allows automatic answering of calls. Operator may call the device at any time, particularly after “Call me” command. After phoning signal – length of which was previously set up – voice connection is established. It is exactly the same as mobile phone conversation. The connection is automatically ended when operator hangs up. The user is unable to end it first. All other functions are blocked for the time of connection.

During conversation, talk to microphone and hold loudspeaker close to ear. For more information on where these parts are located, go to [Functions review](#)<sup>13</sup>.

## ■ Outgoing voice call

Active Track device is able to establish voice call with programmed telephone number (parameter: EMERGENCY). After pushing and holding down "Call me"/"Help me" button Active Track will establish a voice call - just like in cellular phones. To end a voice call it is necessary to push any button (or wait for end of call initialized by another side). When making a voice call all functions of Active Track are disabled.

During conversation, talk to microphone and hold loudspeaker close to ear. For more information on where these parts are located, go to [Functions review](#)<sup>13</sup>.



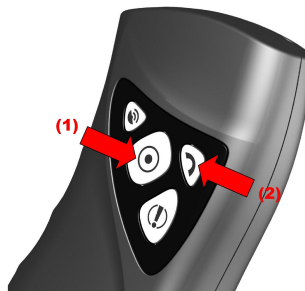

## ■ Checking GSM range

You may check power of your GSM Provider signal at any time by pressing "Checkpoint" until yellow LED light and then "Call" buttons and power of signal will be displayed. For more information, go to [Indicating work mode](#)<sup>69</sup>.

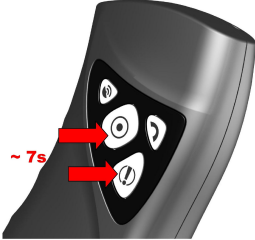

## ■ Reset and turn off

The Active Track device can be reset or turned off, provided that is configured to allow this type of activity (see chapter [Advanced](#)<sup>[45]</sup>). The following describes how to reset / turn off the device

Action	Pressing both Panic and Checkpoint buttons by 7 seconds	Beep	Pressing Panic or Checkpoint button	
Description			RESET	
			TURN OFF	

- RESET - press and hold for about 7 seconds simultaneously the two buttons: Panic and Checkpoint. After this period, and after hearing the audible signal stop pressing buttons. The Panic button should then begin to flash rapidly (this means that the resetting is permitted) for an additional 7 seconds. During this period, only re-press the same Panic button to reset the device.
- TURN OFF - press and hold for about 7 seconds simultaneously the two buttons: Panic and Checkpoint. After this period, and after hearing the audible signal stop pressing buttons. The Checkpoint button should then begin to flash rapidly (this means that the turning off is permitted) for an additional 7 seconds. During this period, only re-press the same Checkpoint button to turn off the device.

## ■ Accelerometer operation

The motion sensor built-in into the device can detect:

- lack of motion of the person holding the device,
- incorrect position of the device against the Earth's gravitational field,
- the device striking too strongly against a hard surface.

It is also possible to determine one's own position and its change in relation to the Earth's gravitational field. This applies to motion both in straight line and along a curved trajectory. In one specific case, however, the change in position cannot be determined – when the motion is taking place exactly and only around the axis parallel to the axis of the gravitational field crossing the sensor. The examples below present situations where it is not possible to detect such rotation (in order to keep the pictures simple the axes of the device cross in its geometrical centre, and not in the

location of the sensor).

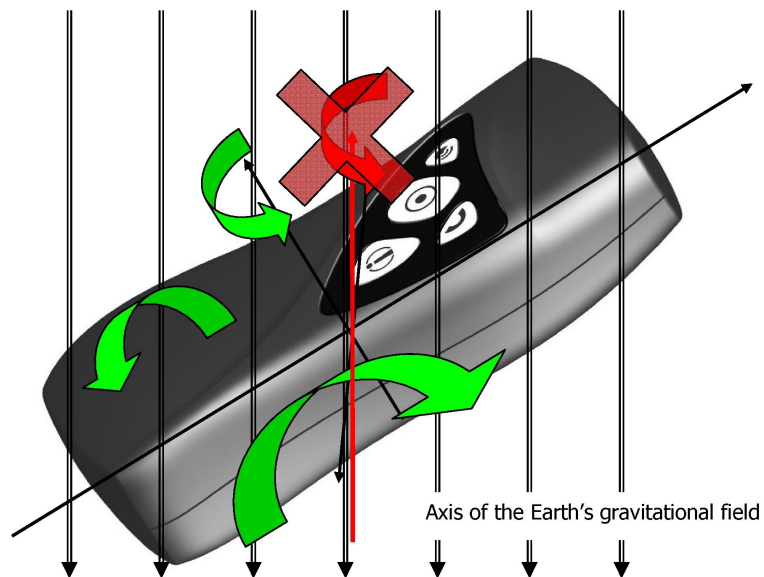
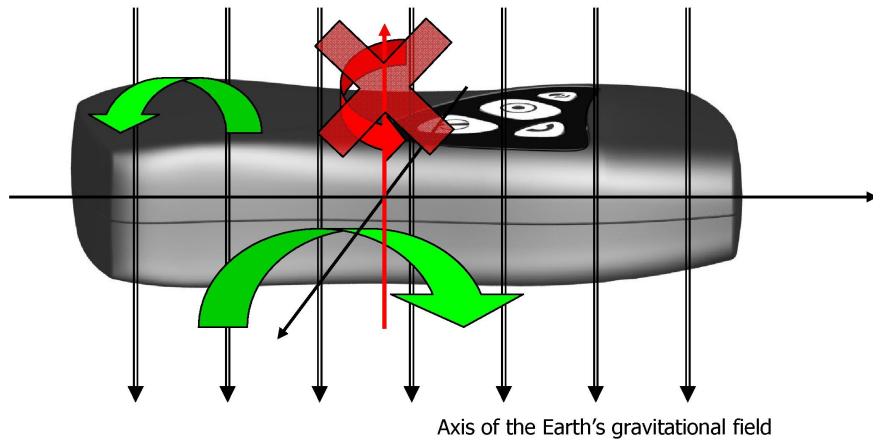

**Note:**

It should be kept in mind that almost any change in location, according to the laws of physics, is a resultant of many forces. In most cases the rotation is not ideally

parallel to the axis of gravitational field going exactly through the middle of the small sensor placed asymmetrically in the device. **Consequently, it can be assumed that the device can detect motion (or lack thereof) of any type.**

## 12 Indicating work mode

Each work mode currently in use will be signalled with adequate flashing combination of buttons.

### ■ Registration at GSM network

Registering is being signalled with slow flashing of "Checkpoint" button.



During normal work, the device signals correct operation with short flashes of "Checkpoint" button every 5 seconds.



### ■ GSM range

Once GSM range checking is started, the device displays GSM signal power (for more information, go to [Checking GSM range](#)<sup>66</sup>). Additionally, after each display work mode is shown (GPRS or GSM). The display consists of flashes of "Checkpoint" button in amount proportional to GSM signal power. Whole sequence is being repeated three times after which the device returns to normal work mode.

Example of single sequence: 4/8 reach, GPRS mode:

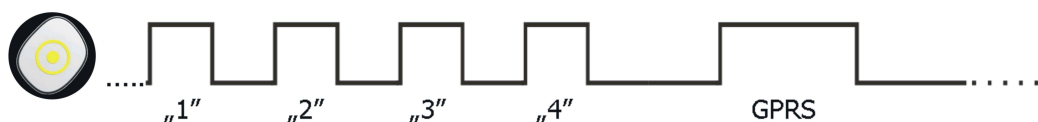

Example of single sequence: 3/8 reach, SMS mode:

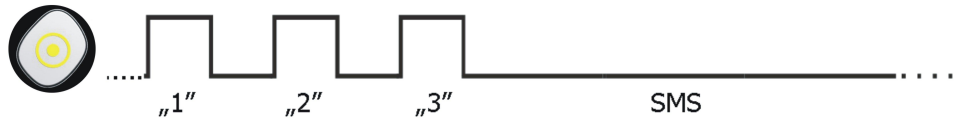

## ■ GPS positioning

GPS positioning is being signalled with slow flashing of „GPS” button.



After get the valid GPS fix, during normal work of GPS, the device signals correct operation with short flashes of “GPS” button every 5 seconds.



## ■ RFID transponder read-out

Version of Active Track with built in RFID transponders reader is able to read-out RFID tags in two ways (like described in chapter [Remote configuration](#)<sup>[21]</sup>): single and repeated read-out. Signaling way is following:

Read-out mode: single (RFID=0,0)

After starting of RFID transponder (see: [RFID transponder read-out](#)<sup>[64]</sup>) device waits for bringing near to the RFID tag. Wait time (15 seconds) is signaled by light on "Read-out" button. Device confirms RFID read-out by double, short acoustic signal and switching "Read-out" button light off and on. Next transmission begins.

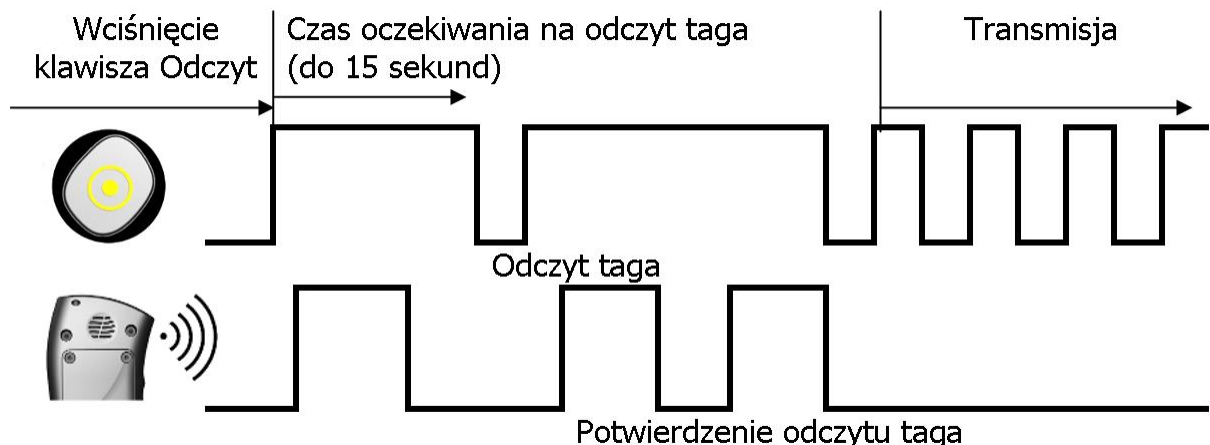

Read-out mode: repeated (RFID=5,5)

After starting of RFID transponder (see: [RFID transponder read-out](#)<sup>[64]</sup>) device waits for bringing near to the RFID tag. Wait time (15 seconds) is signaled by light on "Read-out" button. Device confirms RFID read-out by double, short acoustic signal and switching "Read-out" button light off and on. Next, device waits 5 seconds for next RFID read-out. Each read-out is confirmed in the same way. Data is transmitted after 5 read-outs (FIFO rule)

**Data transmission**

Data transmission is being signalled with quick flashing of "Checkpoint" button.



Data transmission

**Making out-going voice calls**

Procedure of making out-going voice calls begins with pushing and holding "Call me" button. "Checkpoint" LED starts to blink (like when transmitting data). After 2-3 seconds acoustic signal is generated. Holding down the button will generate next acoustic signal (after 2 seconds). Then "Checkpoint" button light will start to blink with frequency of 1Hz.



**Battery low**

When battery low, it is being signalled with 2-hour advance before switching off. "Panic" button flashes every 5 seconds and there are two longer sound signals every minute. It is recommended to charge the device at once (for more information, go to [Battery charging](#)<sup>[19]</sup>).

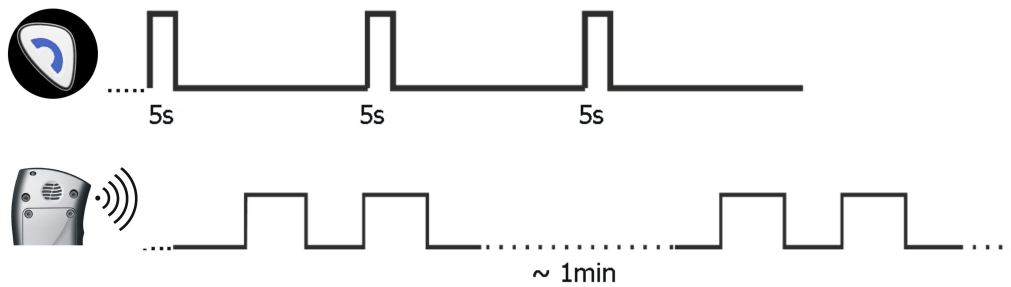

## ■ Battery charging

Once in charger, the device starts charging automatically. It is being signalled with flashing of "Call me" button.

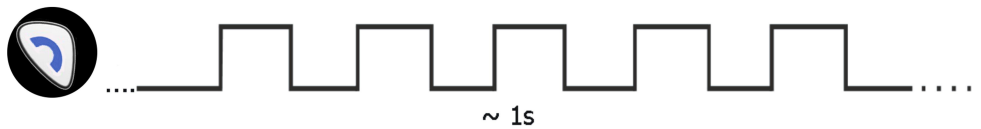

### **Warning:**

When connected device had completely empty battery blue LED may become darker for about 15 minutes.

## ■ Battery full

When battery is fully charged "Call me" button lights up.



## ■ System general error

When error is detected, it is being signalled with alternate flashing of "Panic" and "Call me" buttons. Contact your service immediately.



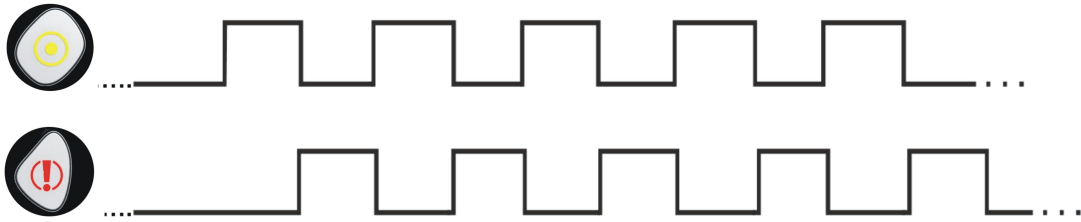

**Note:**

similar signaling may be visible after powering-up device. It may last for 3 minutes and it does not mean failure.

**SIM card error**

In case of problems with the SIM card the device indicates this fact by blinking of "Panic" and "Checkpoint" buttons (the "Panic" button will blink slightly less often and the time of illumination is shorter compared to the blinking of "Checkpoint" button). In such situation you must verify the SIM card mounting and / or its correct operation with a mobile phone.

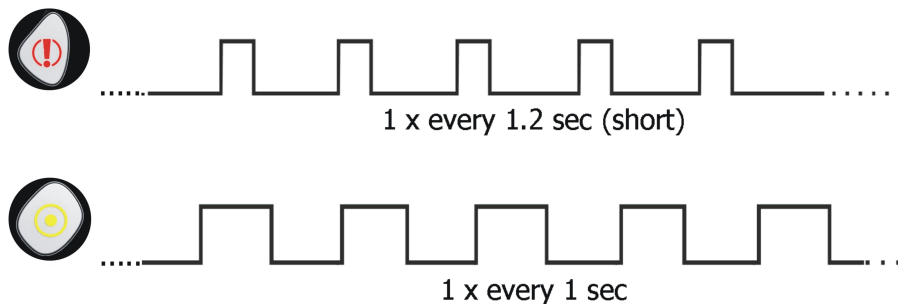

## 13 Cooperation with monitoring system

---

Proper using of all functions of Active Track require monitoring system, which will be able to sent, receive and interpret all messages from Active Track. Main device in that system is receiver (communication server) and Analyzer software. Analyzer software interprets data from Active Track device, store them and visualize them in proper and readable way.

Active Track will sent to the server following information:

### **GPS**

Information about actual device position

### **EMERGENCY**

Pushing of Emergency button will cause sending suitable message to the receiver.

#### **Note:**

Information about pushing Emergency button cannot be send more frequently than once for minute. When button is pushed more frequently, message about second push will not be send (LED will light-up signaling pushing of button).

### **CALL ME**

Pushing "Call me" button will sent proper message.

#### **Note:**

Information about pushing "Call me" button cannot be send more frequently than once for minute. When button is pushed more frequently, message about second push will not be send (LED will light-up signaling pushing of button).

### **RFID**

#### **Note:**

Applies only device version with built in RFID transponders reader.

After RFID read-out , Active Track device will send unique ID of RFID tag. In case of repeated read-out mode data will by sent after last RFID read-out (or after defined time)

### **SABOTAGE**

In case of sabotage (attempt to open the casing) device will send proper message.

### **SHOCK**

Any instance of the device striking too strongly against a hard surface is detected and sent to the monitoring station.

**MANDOWN**

When the emergency consisting immobility of the person holding the device is detected, the corresponding signal is transmitted to the monitoring system.

**TILT**

Detection of incorrect position of the device results in transmission of a signal informing the monitoring system operator of this fact.

**TEST**

For proper control of data transmission channel device is sending to the monitoring receiver periodic signal. That signal ensure that device is working, is connected to GSM network (GPRS, SMS) and is connected to the communication server.

**BATTERY DISCHARGED**

When battery is discharged (read chapter 6. for information about signaling discharged battery), Active Track will sent proper message to the server.

**BATTERY CHARGING STARTS**

When device is charged in appropriate charger, Active Track will sent proper message to the server.

**BATTERY FULLY CHARGED**

When battery is fully charged, proper message will be sent to the receiver.

**BATTERY FULLY DISCHARGED**

When the battery is discharged to the extent not allowing for its further operation, the device saves this information into memory and turns off. Appropriate information is sent to the monitoring system operator after the correct power supply is restored.

**RESET**

The device was manually reset using an appropriate combination of buttons. A report is transmitted after re-establishment of communication link.

**POWER OFF**

The device was manually turned off using an appropriate combination of buttons. A report is transmitted after you turn the device on (using any of the buttons) and re-establishment of communication link.

**CONFIGURATION CHANGE**

Each change of configuration (e.g. SMS message with new settings) will end with sending proper message to the receiver.

**SMS LIMIT**

Reaching the limit of SMS messages sent by the device is reported to the monitoring station in order to allow for subsequent analysis of the system operation.

### **CLIP**

Any incoming call from a number not appearing on the list of authorized numbers results in connection refusal and transmission of the corresponding signal to the monitoring system operator.

### **INCOMING/OUTGOING CALL**

Information on outgoing and incoming calls is sent as a corresponding signal to the monitoring system operator. The exact way of the outgoing call signalling is described below.

### **WATCHDOG**

Following a defined time of GSM/GPRS connectivity disruption the device performs a specified action (e.g. modem reset) and saves appropriate information into memory. When the connectivity is re-established, the information is sent to the monitoring station in order to allow for subsequent analysis of the system operation.

#### **Note:**

If there is no connection between Active Track device and server, Active Track will store events into its internal memory (up to 5000). When connection is established, Active Track will send all events stored in memory in FIFO order with priorities defined in [Monitoring](#)<sup>47</sup>.

#### **Note:**

**Outgoing voice call**, depending on its course is indicated as follows:

- a) When a number is dialled and the recipient rejects the call - generate a couple of events "OUTGOING\_VOICE\_CALL\_BEGIN" and "OUTGOING\_VOICE\_CALL\_END" with the same or similar time and modem answer is added to the events history.
- b) When the connection can not be achieved due to network problems - as in a) point.
- c) When the call is successful - the "OUTGOING\_VOICE\_CALL\_BEGIN" event is generated when the recipient answers the call, and the "OUTGOING\_VOICE\_CALL\_END" event when the connection is terminated. In addition, if the recipient ends the call modem answer is added to the events history.
- d) When the user ends the call before it will be picked up by the recipient - generate a couple of events "OUTGOING\_VOICE\_CALL\_BEGIN" and "OUTGOING\_VOICE\_CALL\_END" without an entry in the history of events with the modem answer.

## 14 Information about batteries

---

### ■ Battery charging and discharging

The device is powered by rechargeable battery.

**Note:**

New battery is not fully charged and requires charging. Full efficiency is reached after 2 or 3 chargings and dischargings!

Battery may be charged and discharged hundreds of times but eventually it would need replacement. If work time becomes noticeably shorter than usual, battery should be replaced with new one.

Use only batteries and charger approved by The Manufacturer. Follow the same advice as for battery chargers. If charger is not in use, plug it off. For safety reasons, do not charge longer than for 7-day time. If full battery is not in use, it will discharge with time.

Extreme temperatures has got adverse impact on charging. Leaving batteries in hot or cold places (i.e. in vehicle in summer or winter time) would shorten lifespan and lower its capacity. Try to keep battery between 15°C – 25°C. The device with excessively hot or cold battery may not work for some time, even if battery is fully charged. In the sub-zero temperatures battery efficiency is especially low. Never dispose of battery into fire!

Battery should be used only according to its specified purpose. Do not ever use inefficient battery or charger. Avoid short circuit of battery polarities, even though it has got system protecting against short circuit.



Used batteries should be recycled or disposed of according to local regulations. Do not throw batteries to public or home dust bins.

## 15 Operation and maintenance

---

The device is a hi-tech Product and requires proper handling. Following instructions below would keep guarantee valid and ensure proper operation for years.

- Keep the device, its parts and accessories out of reach of children.
- Do not expose the device to excessive dirt, dust or water contact.
- Do not keep the appliance expose to high temperature, which shortens the lifespan of batteries and electronic modules.
- Do not store the device in temperatures lower than minimum working temperature due to battery lifespan.
- Do not open the device. Unprofessional interference may cause damage.
- Do not throw, drop or hit the device without reason. Mishandling may cause damage to electronic parts.
- Do not use any solvents or strong detergents chemicals for clearing.
- Do not paint or varnish the device as it may break down buttons or stick connectors.

The above instructions concern the device, its battery, charger and other accessories. In case of malfunction of any element, contact your service to obtain help in solving problem or have it fixed.

## 16 Exemplary implementation

---

- Supervising work of guards, caretakers etc.
- Supervising work of delivery men, e.g. emptying letter boxes.
- Recording presence of service representatives/ technicians in specified places and its lasting time.
- Supervising work of walk or vehicle patrols
- Supervising drivers work or carried loads
- Reporting occurring the events that require supervising

## 17 Technical parameters

<b>GSM module</b>	
u-blox Leon G-100 (850/900/1800/1900 MHz)	
<b>GPS module</b>	
Channels	50 channel u-blox 6 engine
A-GPS online/offline support	YES
Position accuracy	< 2.5 m
TTFH hot start acquisition time	< 1 s average
TTFH cold start acquisition time	< 27 s average
<b>Electrical characteristics</b>	
Power supply	5V/1A
Power socket	standardized Micro USB type B plug
Battery	Li-Polymer, 2400 mAh
Battery working time (GPS position and test every 60s)	24 hours
<b>Physical characteristics</b>	
Dimensions (HxWxT)	121x60x30 mm
Casing durability	The waterproof and shock resistant housing
Weight	175g (device); 30g (charger)
<b>Motion sensor</b>	
3-axis motion sensor (accelerometer)	
<b>RFID reader (optional)</b>	
Reader type	Proximity RFID
RFID reader frequency	125kHz
RFID read-out distance	3-4cm (depends on transponder type)
<b>Interfaces &amp; general features</b>	
Internal speaker and microphone	
4 Buttons for easy operating	
Ambient operating temperature: -20 °C to +60 °C	
Data transmission via GPRS (TCP, IP), SMS to OSM.2007	
Voice call	
Silent call	
Remote administration & firmware update	
<b>Configuration</b>	
Local: PC through RS232 link (LX cable and AGP3 programmer required)	
Remote: via GPRS, SMS, CSD	
Alarm events buffer size	1000
Quantity of system events stored in history	2000