

# EPOS

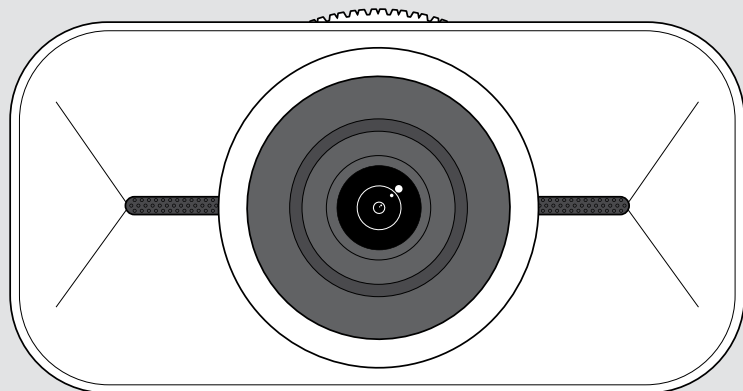

## EXPAND Vision 1

4K personal USB camera

User Guide

Model: DSWD1

# Contents

Welcome .....	2
Package contents .....	3
EXPAND Vision 1 at a glance .....	4
How to mount the EXPAND Vision 1.....	5
A: Mounting on a screen / monitor.....	5
B: Mounting on a tripod – optional.....	6
How to connect and set up .....	7
Connecting to a computer.....	7
Installing EPOS Connect and the Floating menu .....	8
Updating the firmware.....	9
How to use – the basics.....	10
Adjusting the webcam's height.....	10
Standby mode & waking up.....	11
Opening the Floating menu .....	12
Opening EPOS Connect.....	13
Changing the zoom level .....	14
Joining meetings / calls.....	16
Good to know.....	17
Fine-tuning the webcam's image.....	17
Muting / unmuting the microphones .....	18
Changing the microphone volume.....	18
Using the privacy shutter.....	19
How to care for your EXPAND Vision 1.....	20
Cleaning the product.....	20
Carrying and storing the product.....	21
If a problem occurs.....	22

# Welcome

## Conference Camera That Goes Where You Go

Complete your hybrid work setup with the EXPAND Vision 1.

This compact, portable USB webcam delivers ultra-sharp video and exceptional voice pickup whether you work from home, on the go, or in an individual office space.

Look and sound professional with EPOS Audio™ and a 4K camera optimized to produce the best picture in any light conditions.

Experience effortless video conferencing with two noise-cancelling microphones that ensure you are heard clearly.

Adjust the picture quickly and easily in just a few clicks, with control over key settings like field of view, light and color.

## Key benefits & features

### Ultra-high-definition video

Look professional on any video call with the ultra-sharp 4k camera that optimizes the picture based on light conditions

### Exceptional voice pickup

Be heard clearly thanks to two omni-directional, noise-cancelling microphones that pick-up the voice instead of background noise

### Instant picture control

Find the best picture setting with the smart floating menu that lets users adjust the field of view, light, and color

### Quick and easy setup

Set up anywhere in seconds. The integrated mounting clip is designed to fit any monitor and ensures the right position every time

### Certified solution

Certified for leading UC solutions including Microsoft Teams and Zoom, providing flawless user experience and trusted stamp of approval



For safety instructions, consult the Safety Guide.



For specifications, consult the Fact sheet available at [eposaudio.com](https://www.eposaudio.com)

### Trademarks

USB Type-C® and USB-C® are trademarks of USB Implementers Forum.

All other trademarks are the property of their respective owners.

# Package contents

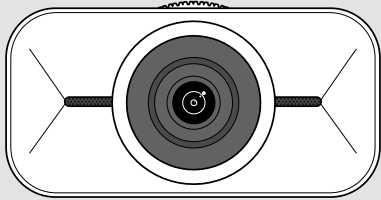

**EXPAND Vision 1**  
4K personal USB camera

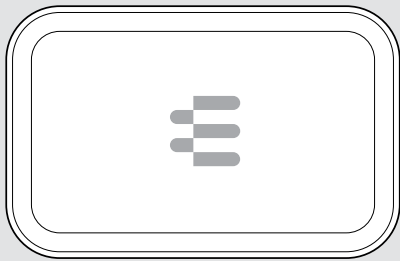

**Carry case**

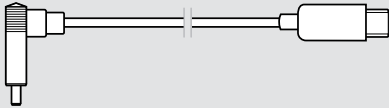

**USB cable**  
with USB-C® to USB-C® connector

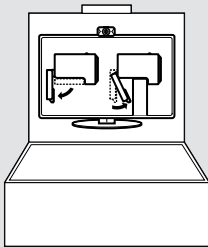

**Quick Guide**  
printed inside the box



**Safety Guide**  
Compliance sheet

# EXPAND Vision 1 at a glance

FRONT

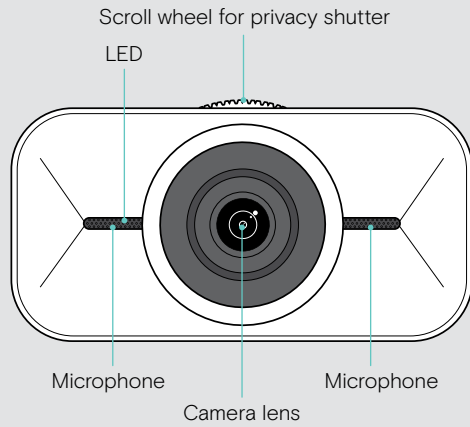

REAR

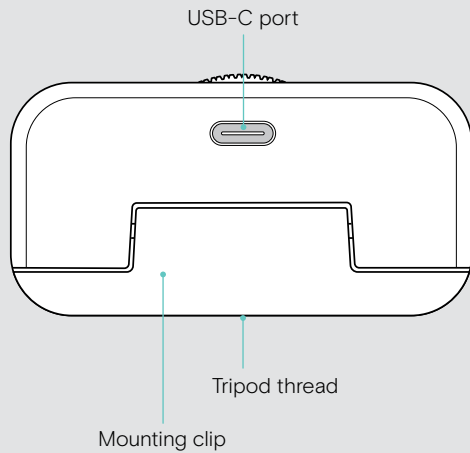

# How to mount the EXPAND Vision 1

You can mount your USB webcam:

- **A** on top of a screen / monitor **or**
- **B** on a desk with an optional tripod.

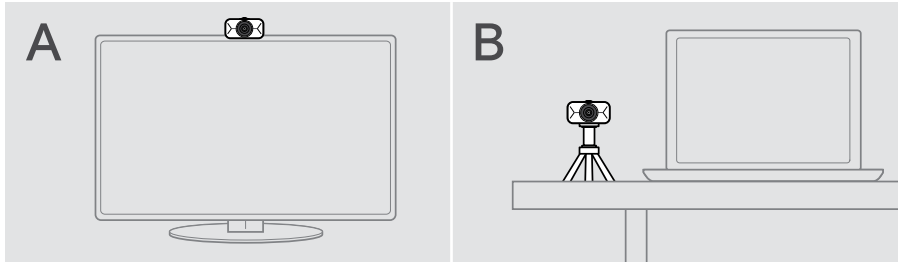

## A: Mounting on a screen / monitor

- > Fold down the mounting clip.
- > Put the EXPAND Vision 1 on the top of your screen or monitor.
- > Hold down the product and rotate the mounting clip and its foot so that it is fixed securely on your device.

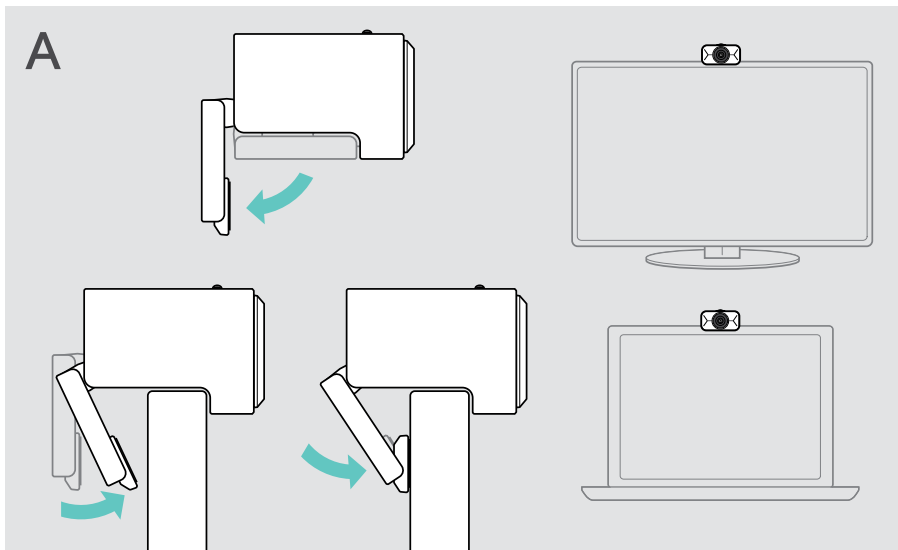

## B: Mounting on a tripod – optional

---

You can attach the EXPAND Vision 1 to any tripod with a standard 1/4" thread.

- > Fold up the mounting clip.
- > Follow the instructions of your tripod to mount the EXPAND Vision 1 securely.
- > Place the tripod on your desk so that the webcam points in your direction.

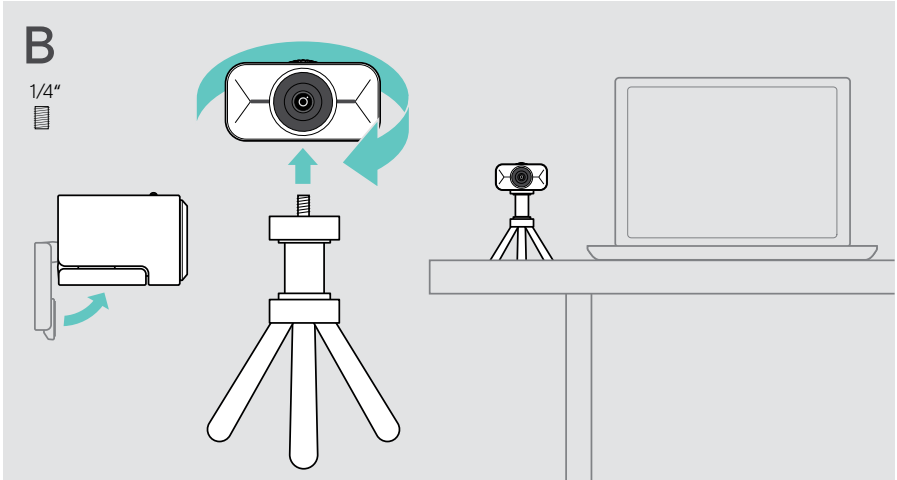

# How to connect and set up

## Connecting to a computer

---

- > Switch on your computer.
- > Connect the angled plug of the USB cable to the USB-C port of your EXPAND Vision 1.
- > Connect the USB-C plug to your computer.  
The EXPAND Vision 1 switches on. The LED lights up shortly. The Floating menu appears automatically, if you have installed EPOS Connect already (otherwise: see next chapter).

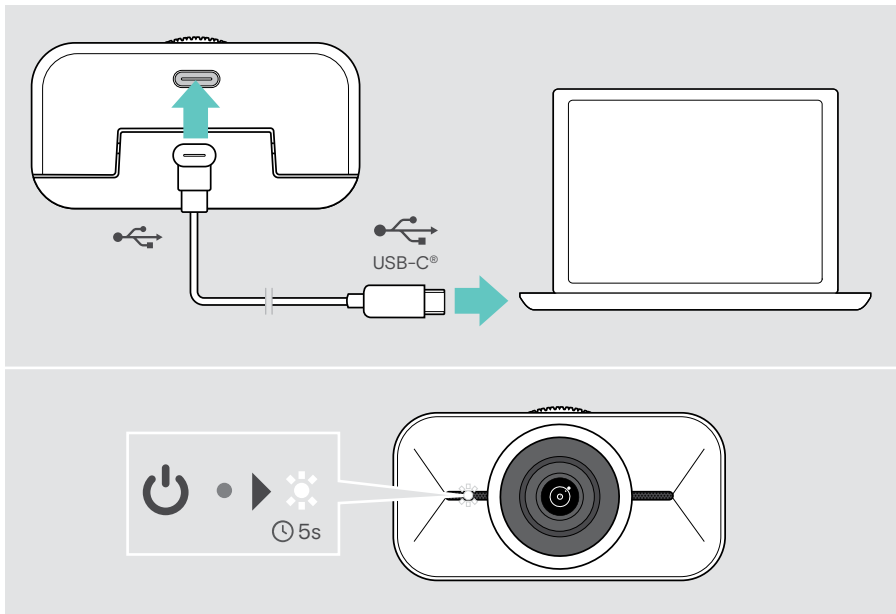



## Installing EPOS Connect and the Floating menu

You can change the webcam settings via EPOS Connect or the Floating menu: e.g. swap between different zoom levels, mirror the image and adjust lighting and temperature.

The Floating menu is installed together with EPOS Connect. For how to open the Floating menu see page 12.

- 1 Download the free [EPOS Connect](https://www.epos.link/connect) software from [epos.link/connect](https://www.epos.link/connect).
- 2 Install the software. You need administrator rights on your computer – if necessary, contact your IT department.

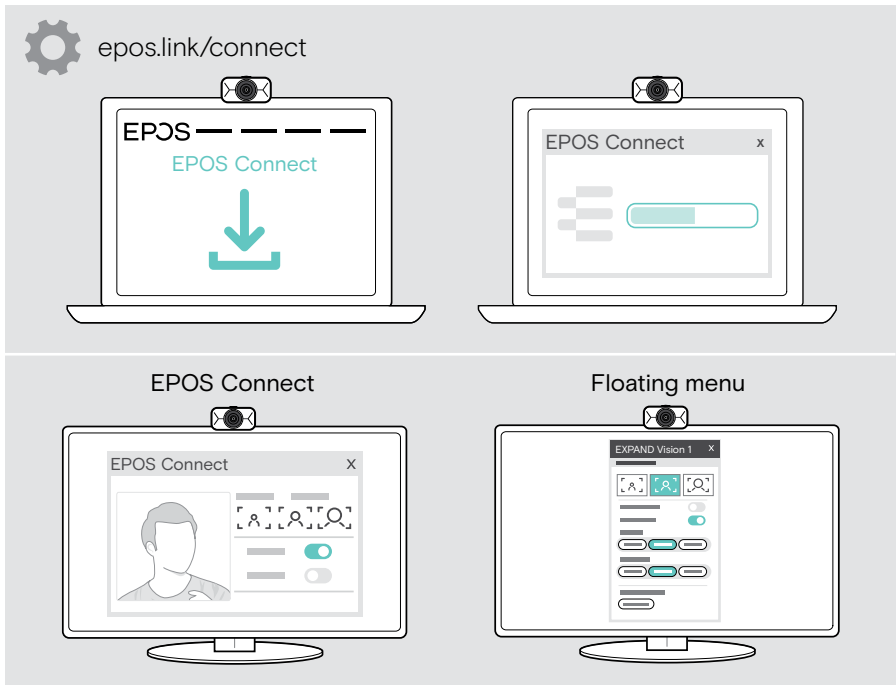

To make sure, the newest features are available, update the firmware (see next chapter).

## Updating the firmware

---

To have the newest features available:

- > Connect the USB cable to the EXPAND Vision 1 and your computer (see page 7).
- > Start EPOS Connect. If there is a new firmware available, the software will guide you through the update process.

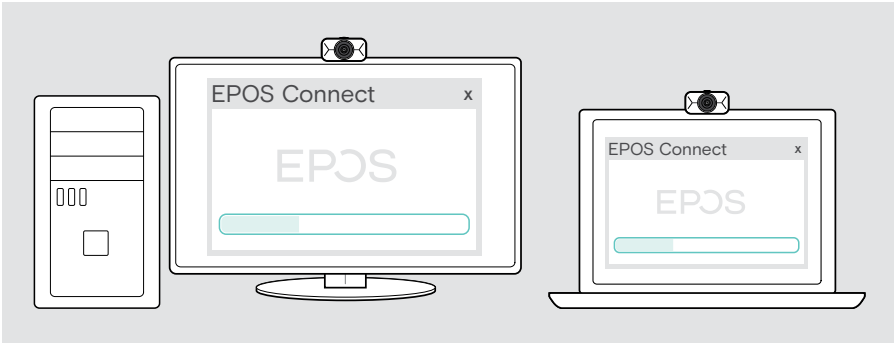

# How to use – the basics

## Adjusting the webcam's height

---

- > Open your UC solution or EPOS Connect to have the camera picture available.
- > Hold down the mounting clip's foot and move the webcam up or down.

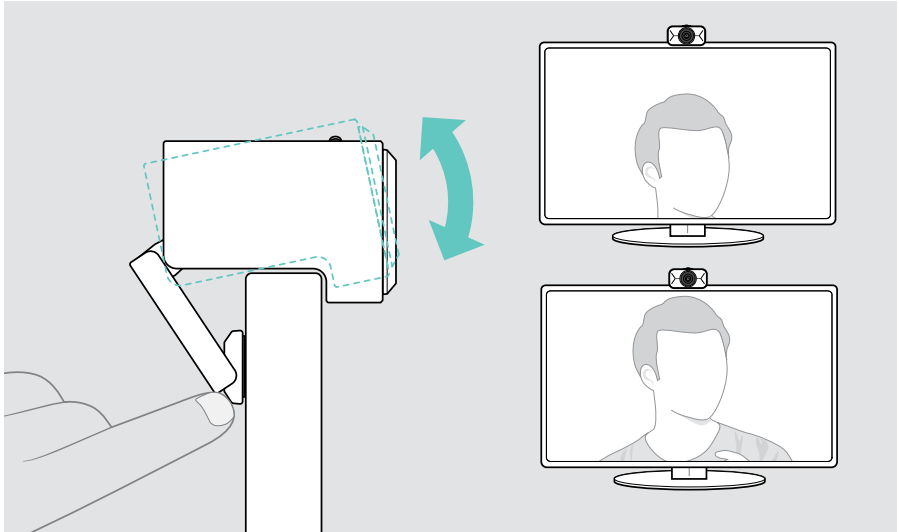

## Standby mode & waking up

The EXPAND Vision 1 turns on automatically as soon as it is connected to your computer. If the webcam is not in use, it turns to standby mode to save energy.

To wake up your EXPAND Vision 1:

- > Start to use the webcam e.g. via your UC solution.  
The LED lights up white as long as you are in the call.

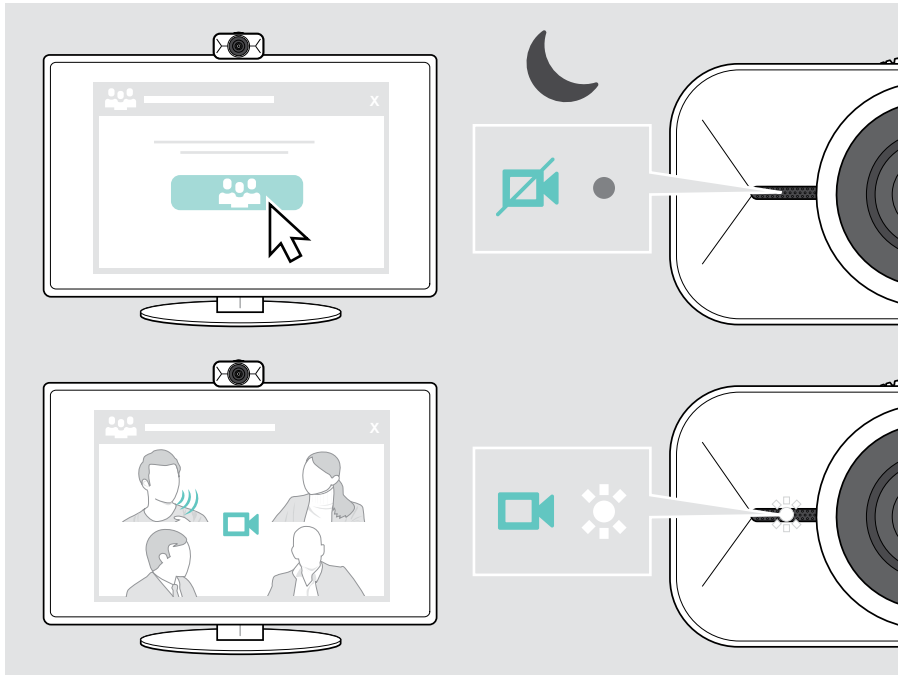

## Opening the Floating menu

---

The Floating menu appears automatically\*, if you connect the webcam to your computer (EPOS Connect needs to be installed).

If you have closed the Floating menu:

- > Click on the EPOS Connect icon in the task bar and select “EXPAND Vision 1” to open it.

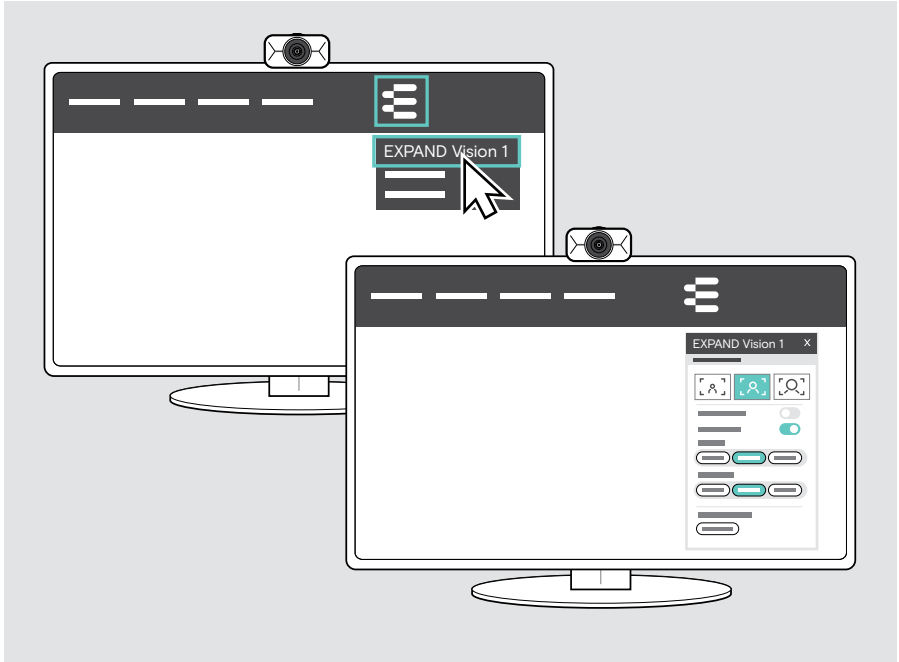

All your changes in the Floating menu settings will be saved automatically.



\*The automatic pop up of the Floating menu can be disabled via EPOS Connect.

---

## Opening EPOS Connect

---

EPOS Connect offers the same settings as the Floating menu. In addition, you can e.g. update the firmware of the product.

- > Open EPOS Connect and click on “EXPAND Vision 1”.

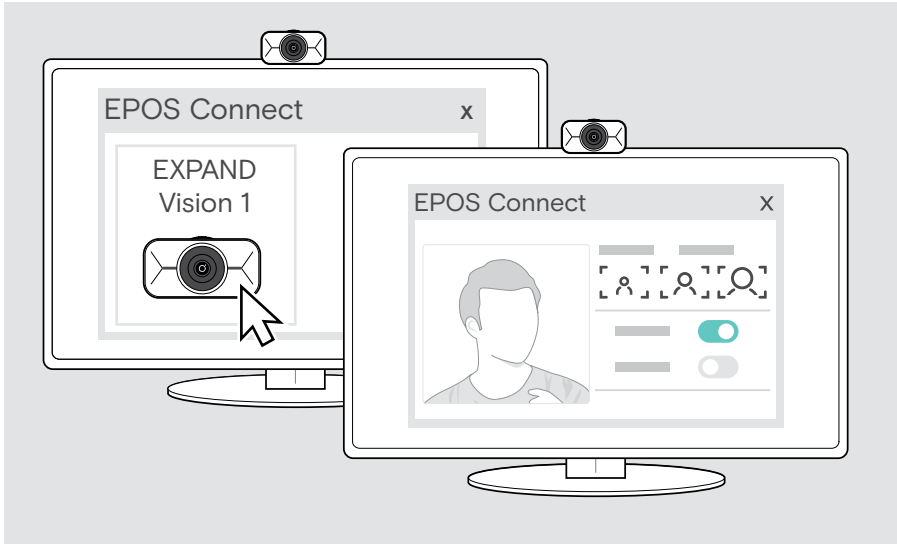

All your changes in the EPOS Connect settings will be saved automatically.

---

## Changing the zoom level

The webcam's zoom level can be changed via the Floating menu or EPOS Connect. If you use the Floating menu: Open up your UC solution to see the camera picture.

You can change the zoom level:

- A quickly, by using one of the 3 presets or
- B in small steps via the Advanced menu.

### A: Changing the zoom level via the presets

- > Click one of the zoom level icons.  
The lens adjusts to the selected angle.

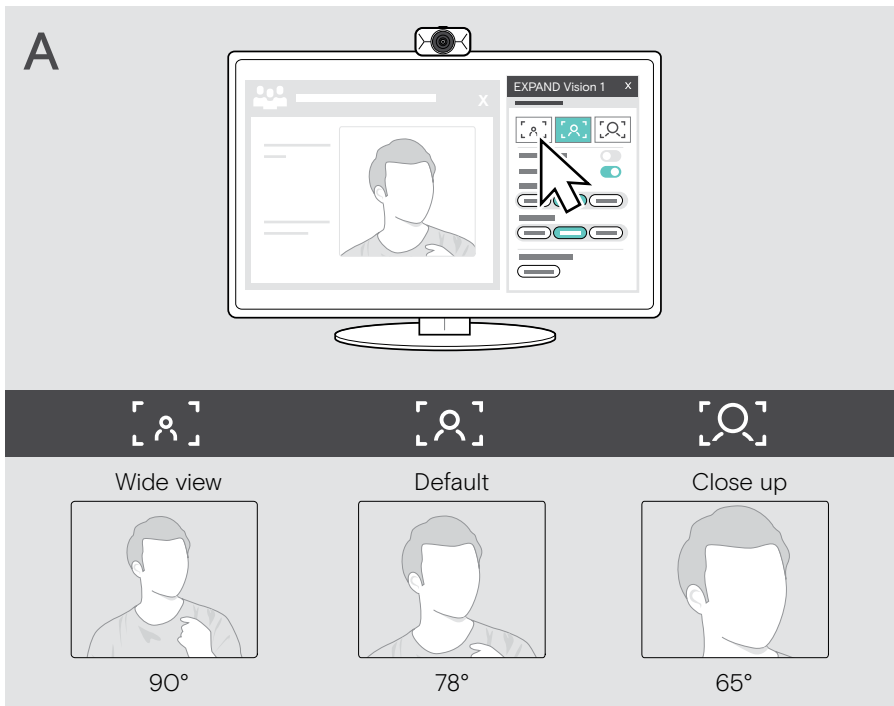

## B: Adjusting in smaller steps - Advanced menu

- > Go to the tab "Advanced".
- > Use the slider or the + and - buttons to zoom in or out in smaller steps. The lens adjusts to the selected angle.

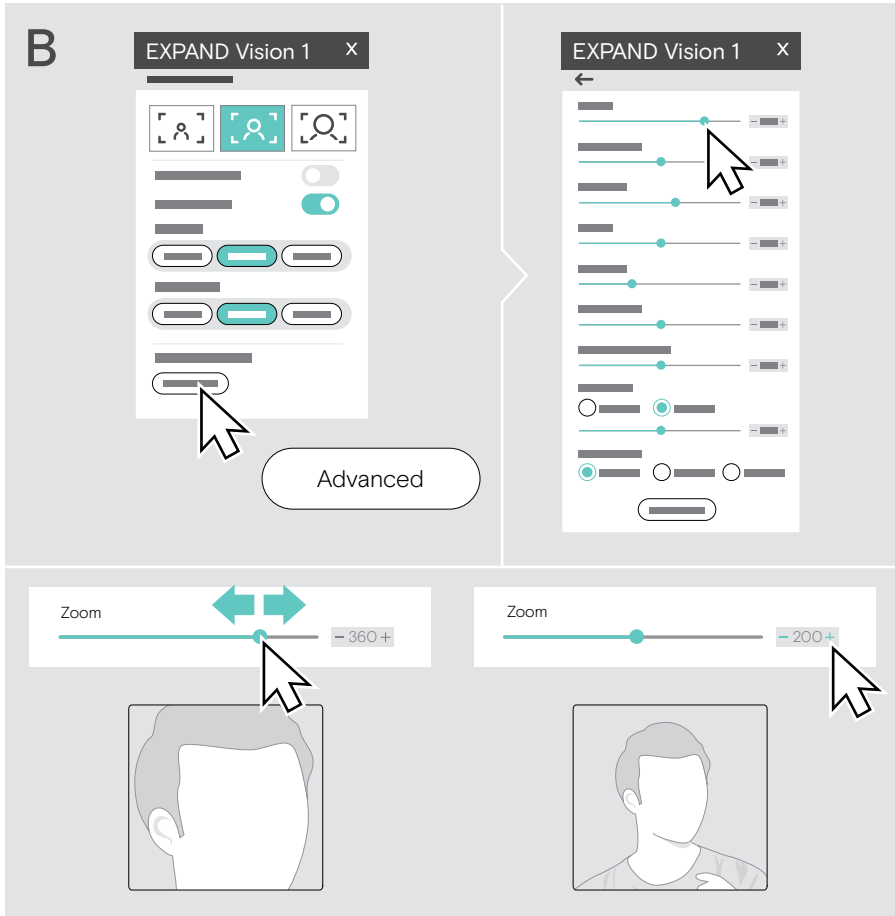



## Joining meetings / calls

---

You can join meetings and calls via your UC solution (e.g. Zoom, Microsoft Teams, Google Meet).

- > Join your meeting or initiate a call via your UC solution.  
The webcam and the microphones get active. The LED lights up white.

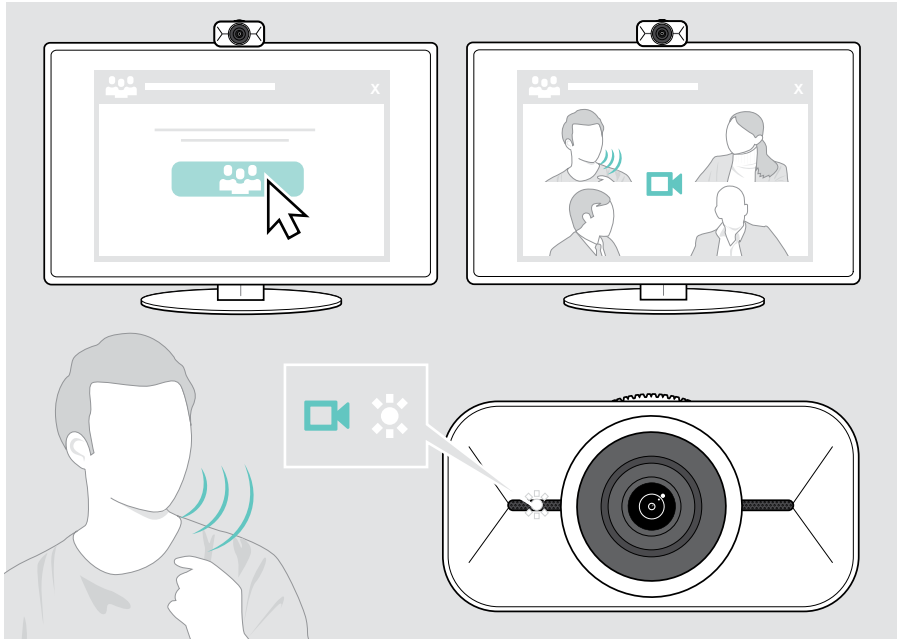

# Good to know

## Fine-tuning the webcam's image

You can adjust the webcam's image via the Floating menu or EPOS Connect. If you use the Floating menu: Open up your UC solution to see the camera picture.

> Adjust the webcam's image via the presets in the Basic settings.

To change the settings even more precisely, use the Advanced menu:

> Click on "Advanced" and make your personal adjustments.

If anything goes wrong or to go back to default settings, click on "Reset" in the Advanced menu.

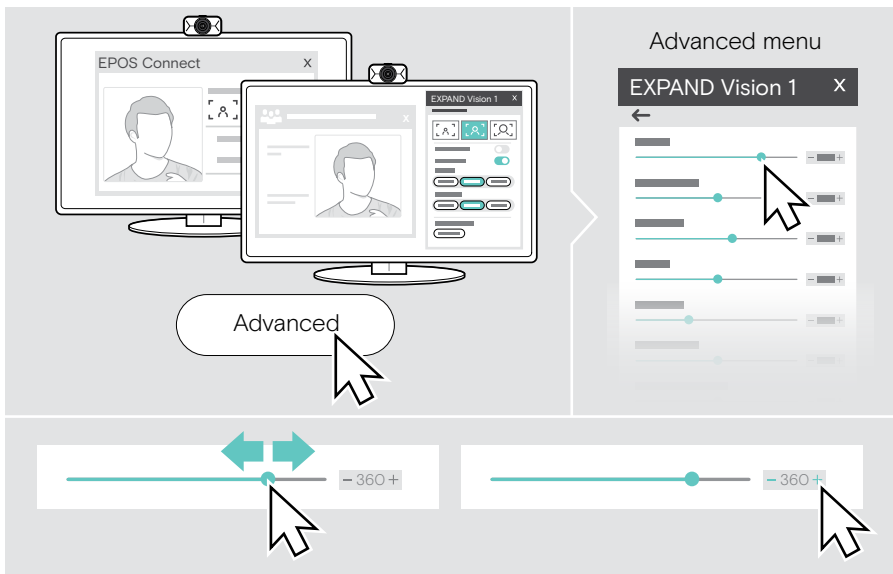

### Basic settings

- Zoom (3 zoom level presets)
- Mirror Image
- Anti Redness
- Light
- Temperature

### Advanced settings

- Zoom (small steps)
- Brightness
- Contrast
- Hue
- Saturation
- Sharpness
- Exposure compensation
- White Balance
- Anti-flicker

## Muting / unmuting the microphones

The EXPAND Vision 1 comes with two noise cancelling microphones for clear voice pickup.

- > Mute or unmute the webcam's microphones via your UC solution.



## Changing the microphone volume

- > Initiate a call via your UC solution to someone who will help you find the correct volume setting for your EXPAND Vision 1 microphones.
- > Change the microphone volume in your UC solution and/or in your computer audio application.

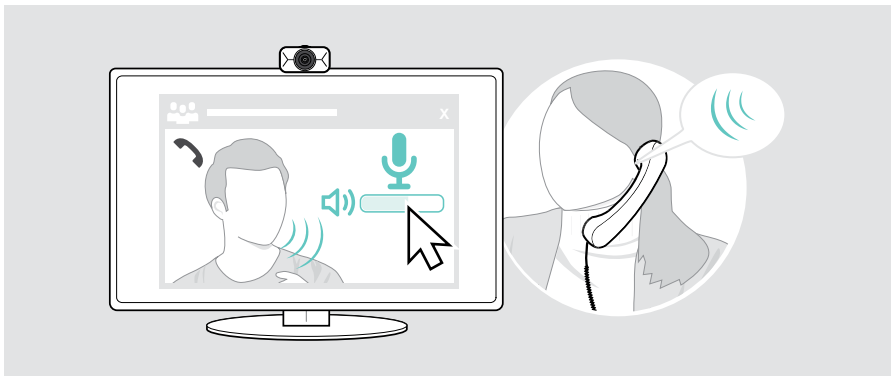

## Using the privacy shutter

For additional privacy, your EXPAND Vision 1 is equipped with a scroll wheel for disabling the webcam.

- > Turn the scroll wheel for privacy shutter:
  - clockwise, to close the lens **or**
  - counter-clockwise, to open the lens.

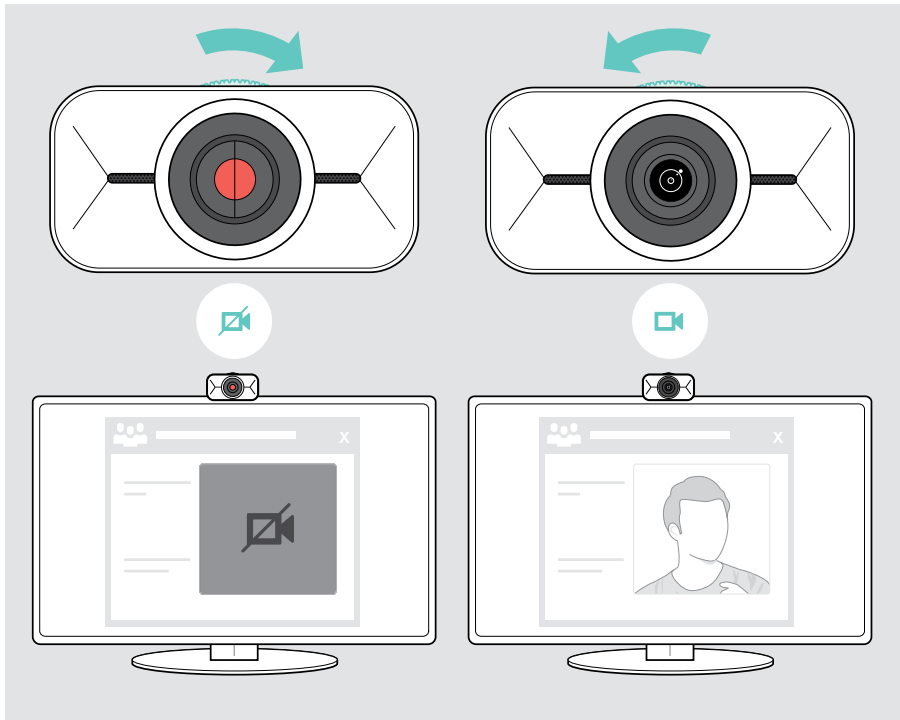

# How to care for your EXPAND Vision 1

## Cleaning the product

---

### CAUTION

Liquids can damage the electronics of the product!

Liquids entering the housing of the device can cause a short circuit and damage the electronics.

- > Keep all liquids far away from the product.
  - > Do not use any cleansing agents or solvents.
- > Use a dry cloth to clean the product only.

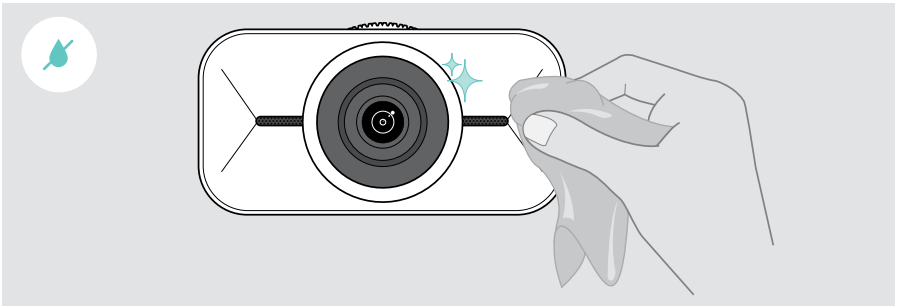

## Carrying and storing the product

---

For carrying around or when not in use for extended periods of time, store the product in the carry case. This will help to avoid scratches and keep the product in good condition.

- > Unplug the USB-C cable and wind it up.
- > Unmount the webcam and fold up the mounting clip.
- > Put them in the carry case.

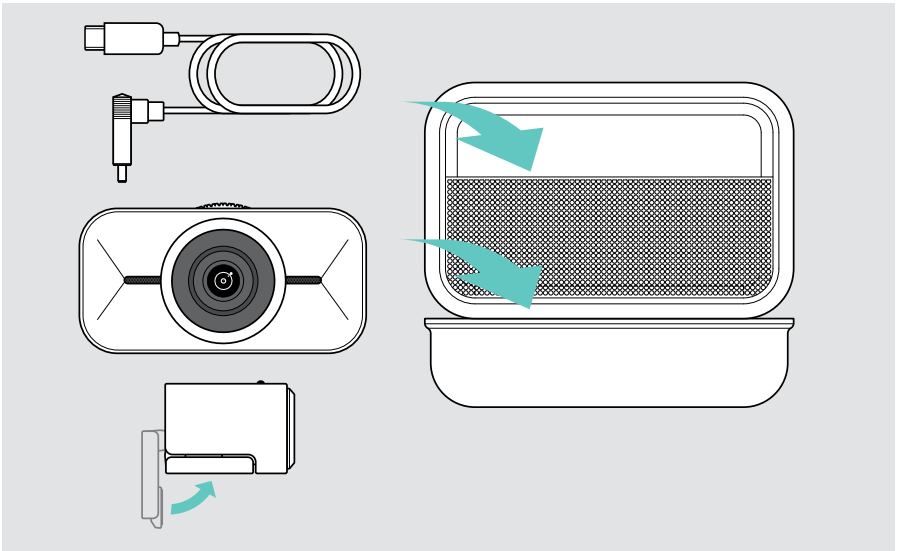

## If a problem occurs...

Problem	Possible cause	Solution	Page
Webcam image not displayed correctly	Webcam position not optimal	> Align the height of the webcam.	10
		> Change your position to be in front of the webcam.	–
		> Change the position of the webcam on your screen/monitor or the position of your tripod.	5
		> Change the zoom level.	14
No picture or audio	Connector not inserted correctly	> Check the cable connection.	7
	Microphones muted	> Unmute the microphones via your UC solution.	–
	Speaker(s) muted	> Unmute the speaker(s) of your connected device (e.g. laptop).	–
	Privacy shutter in use (lens closed)	> Open the privacy shutter.	19
	Webcam not selected as audio device (Microsoft Windows)	> Right-click the Audio icon. > Select the webcam under input as microphone.	–
Low video or audio quality	Poor internet connection	> Check your internet connection performance.	–
	Plastic protection on lens not removed	> Remove the plastic protection.	–
Floating menu not available	EPOS Connect not installed on the connected device	> Install EPOS Connect.	8
	Computer has been turned off / Floating menu has been closed	> Open it via the EPOS Connect icon in the task bar.	12
		> Unplug the webcam's USB-C connector and plug it in again. The Floating menu will automatically open up.	12
Picture dark/light	Settings misadjusted	> Change the settings via the Floating menu or EPOS Connect.	17
		> Click on "Reset" in the Advanced menu (Floating menu / EPOS Connect).	17

If a problem occurs that is not listed here or if the problem cannot be solved with the proposed solutions, please contact your local EPOS partner for assistance. To find an EPOS partner in your country, search at [eposaudio.com](https://eposaudio.com).

# EPOS

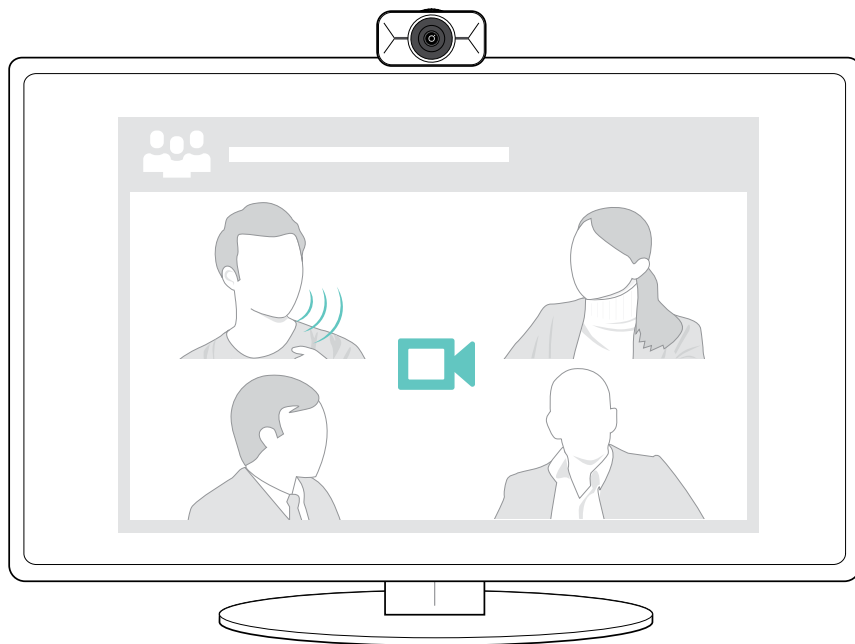

**DSEA A/S**

Kongebakken 9, DK-2765 Smørum, Denmark

[eposaudio.com](http://eposaudio.com)

Publ. 08/22, A01