



NEO Cylinder - AUS

Reference: **NMA1100N00CSBNR**

Price: 820,45 NZD\$ MSRP Price

Currency: **NEW ZEALAND (NZD)**

Pricelist Date: **January 2024**

Date: **2024-11-21**

MODEL

NMA1

SALTO NEO Australian oval profile electronic cylinder Exterior cylinder, one knob, no thumbturn.

Technology: Mifare, Bluetooth LE + HSE.

Mifare, Bluetooth LE + HSE. Standard - standard length, standard cams, standard finish.

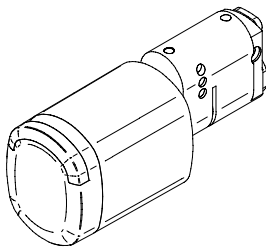

Measures

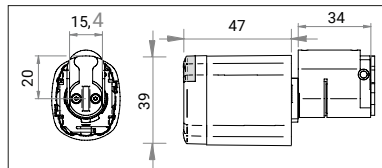

Profile cylinder

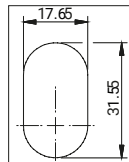

Cams

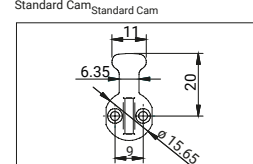

PRODUCT TYPE

N | SALTO NEO Electronic cylinder

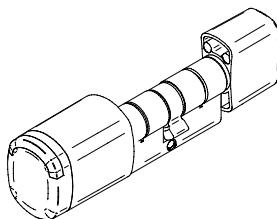

ID TECHNOLOGY

M | Mifare Desfire + Bluetooth LE + HSE

MODEL

A1 | Australian oval profile cylinder.

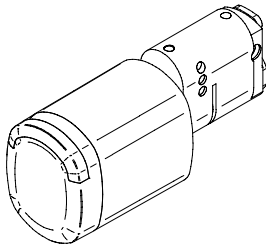

KNOB TYPE

1 | Standard removable knob, the battery can be changed .

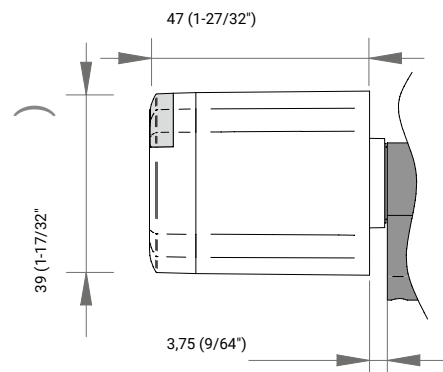
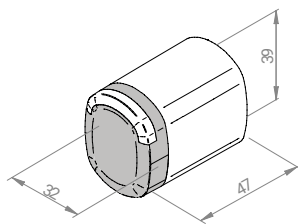

LEXT

00 | 00

THUMBTURN DESIGN

N | No thumbturn

LINT

00 | 00

KNOB FINISH

CS | Satin Chrome



READER COLOR

B | Black reader



CAMS

N | No applicable

CERTIFICATION

N | No special certification

WATER RESISTANCE

R | IP66 Rating Water Resistant (SKG*** & VDS
Cylinders are IPP66 as standard)

+31,60 NZD\$

Disclaimer:

SALTO Systems Price Book ("SALTO Price Book") is a digital tool aimed at helping partners to consult information about SALTO Systems' products and prices.

Images and prices displayed in and/or downloaded from SALTO Price Book are for illustrative purposes only and are designed to visualize the product or option selected including indicative information about its features and prices. SALTO Systems seeks to procure that the content of the SALTO Price Book is of the highest possible quality and reasonably up-to-date; however, it does not guarantee its usefulness, accuracy, completeness, relevance or that it is up-to-date. Therefore, all images, illustrations, shapes, features, specifications, sizes, data, descriptions, colors and prices shown in the SALTO Price Book shall be considered as no-binding approximate indications only.

SALTO Systems assumes no liability whatsoever as a result of any incomplete or incorrect information shown to or obtained by the client through the SALTO Price Book, nor it assumes any kind of liability whatsoever in case that the product configuration made by the partner through SALTO Price Book is not available and/or is not technically feasible. For a complete description of the product range, for a verification of the availability and technical feasibility of the selected product configuration and/or for a commercial offer please contact with the local SALTO office.

For the avoidance of any doubt, any information contained in SALTO Price Book or the documents downloaded do not constitute an offer of SALTO Systems to the client, neither shall it be interpreted as the assumption by SALTO Systems of any contractual obligation whatsoever. The sale of the products and services rendering by SALTO Systems are subject to the applicable version of the "General Terms and Conditions of Sale" available in [General Terms and Conditions of Sale - SALTO Systems](#).

This Disclaimer is ruled in every point by the Spanish Law. More information available in [Legal Warning - SALTO Systems](#).

Since 2001, SALTO Systems has been delivering state-of-the-art wire-free and keyless electronic access control solutions. SALTO is driven by continuous improvement and is committed to developing the most technologically-advanced and flexible electronic locking solutions for any kind of door and user needs. SALTO has established itself as a global market leader in electronic access control solutions. SALTO continues to grow the value of its brand, and today, SALTO is synonymous with innovative solutions that set new standards in security, manageability, flexibility and design that bring real-world benefits. The pioneering SALTO Virtual Network SVN data-on-card and technology platforms provides stand-alone, smart locking solutions that continue to set SALTO apart. More recently, the company's technological expertise has brought SALTO to leading positions in both cloud-based access control technology and mobile access solutions.

Having revolutionized access control in a vast number of industries and applications – from office, education, healthcare, transport and commercial buildings to business access, hospitality and residential – SALTO continues to deliver industry-leading electronic locking solutions to markets across the globe.

© 2024 SALTO SYSTEMS, S.L. All right reserved