



PSATS3K

Automatic Transfer Switch (ATS)



USER GUIDE

Table of Contents

1. Introduction.....	3
2. Product Overview	3
3. Important Safety Warnings.....	4
4. Operation Indicators & Status	4
5. Installation.....	6
6. Operation	7
7. Communication Port.....	7
8. Trouble Shooting.....	9
9. Specifications	10
10. Appendix.....	11
11. Warranty.....	12

1. Introduction

The PowerShield® ATS is designed to accept two independent power inlets (primary and secondary) to supply power to the load from either power source. Should primary power source fail, the secondary will automatically back up the connected equipment without any interruption. The transfer time from one line to another is seamless to the connected equipment. After switching to a secondary power source, the ATS can also switch power back to the primary input when power to the primary input is restored.

Package contents:

- ATS module
- User manual
- CDROM - ATS Monitoring software
- Mounting brackets
- 2 x power cord - 15 Amp Australian 3-pin plug to 15Amp IEC C19 socket
- 1 x power cord - 15Amp IEC C19 socket to IEC C20 plug
- 2 x power cord - 10Amp IEC C13 socket to IEC C14 plug
- 1 x USB cable

2. Product Overview

Front View:

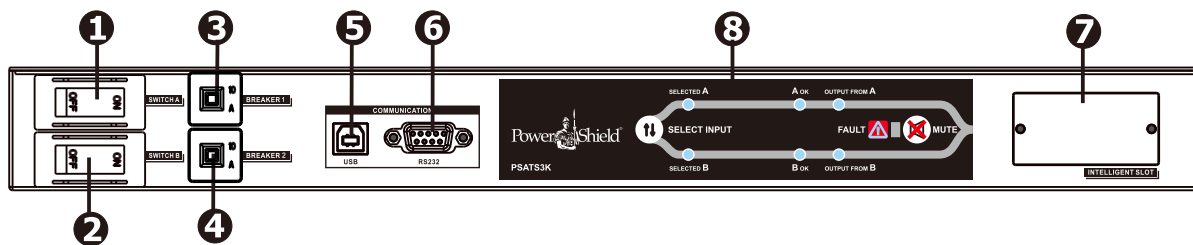

- ❶ Power switch for input source A
- ❷ Power switch for input source B
- ❸ Circuit breaker for output 2
- ❹ Circuit breaker for output 3
- ❺ USB communication port
- ❻ RS-232 communication port
- ❼ Communication slot
- ❽ Operation indicators (please refer to section 4 for the details)

Back View:

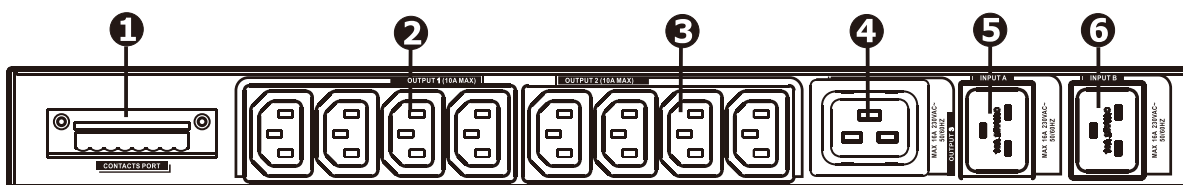

- ❶ Contact port (please refer to section 7 for the details)
- ❷ Output receptacles "Output 3" (IEC 10A)
- ❸ Output receptacles "Output 2" (IEC 10A)
- ❹ Output receptacle "Output 1" (IEC 16A)
- ❺ Input source A connector
- ❻ Input source B connector

3. Important Safety Warnings

Before using the unit please read all instructions and cautionary markings on the unit, this manual and the batteries.

WARNING!! The ATS must be connected to earth when in use.

In line with current regulations, only use the cables that have been supplied with the machine. The power supply socket must be easily accessible to the operator.

WARNING!! The ATS has been designed exclusively to operate indoors. It is essential to install it in areas where no inflammable liquids or gases, or other harmful or noxious substances, have been stored.

ATTENTION!! A soft damp cloth may be used to clean the outside of the machine (always with the system disconnected from the mains power supply and load).

Do not use any type of solvent as this may damage the external finish of the machine.

ATTENTION!! The ATS has been designed exclusively for professional use.

NOTE: These instructions may be modified by the wiring regulations in force in the country where the ATS is purchased.

4. Operational Indicators & Status

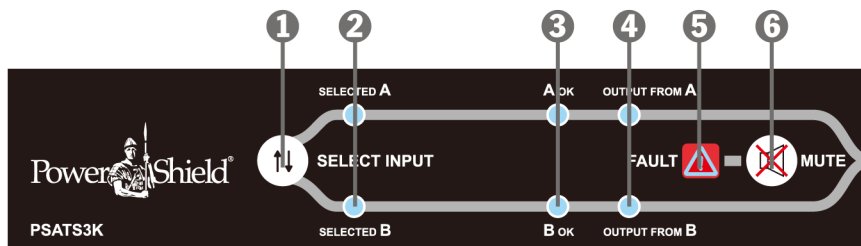

- ❶ Preferred Source Selector
- ❷ Priority setting LEDs
- ❸ Power source status LEDs
- ❹ Output source LEDs
- ❺ Fault indicator
- ❻ Alarm mute button

LED Indicators and Alarms

Indication type	LED description	LED status	Condition	Alarm
Priority setting LEDs	Source A (2)	ON	Source A is Preferred	OFF
	Source B (2)	OFF		
	Source A (2)	OFF	Source B is Preferred	OFF
	Source B (2)	ON		
Power source status	Status of source A (3)	OFF	Inlet A has no power input	OFF
		ON	Inlet A has power input, and power is OK	OFF
		Flashing	Inlet A has power input, but power is out of SPEC	OFF
	Status of source B (3)	OFF	Inlet B has no power input	OFF
		ON	Inlet B has power, and power is OK	OFF
		Flashing	Inlet B has power input, but power is out of SPEC	OFF
Output status	Output from source A (4)	ON	Output on Source A	OFF
	Output from source B (4)	OFF		
	Output from source A (4)	OFF	Output on Source B	OFF
	Output from source B (4)	ON		
	Output from source A (4)	OFF	NO OUTPUT	OFF
	Output from source B (4)	OFF		
Alarm	Fault (5)	OFF	No Alarms present	OFF
		ON	Alarm present	Continuously

5. Installation

NOTE: Before installation, please inspect the unit. Be sure that nothing inside the package is damaged.



Mounting the Unit

The unit can be mounted in a standard 19" rack using the PowerShield optional Rail Kit. Fasten the mounting brackets to the unit using the screws provided.

Power Shield Rail Kit mounting

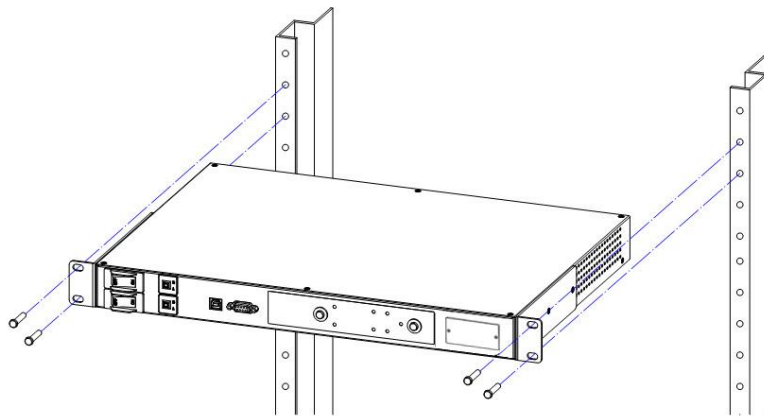
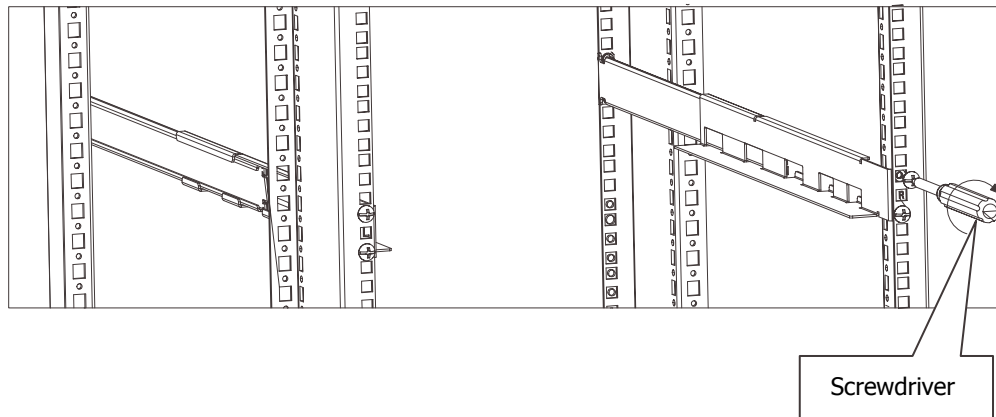

NOTE: If the ambient temperature exceeds 40 °C, ventilation is required

Connecting the Unit

Connect the ATS input plugs "input source A connector" and "input source B connector" to the two independent power sources or UPSs using either the SCHUCKO-IEC or IEC-IEC 16A cables supplied.

Plug the load into the output 10A ("Output 1 and 2") or 16A ("Output 3") sockets depending on requirements.

6. Operation

Power On/Off

Turn the input power switch to the "ON" position. The output will then be supplied by the source set as selected.

Setting the Preferred Power Source

It is possible to set the power source preference by pressing "source preference selector". The default power source is "Source A".

Function	Description	Default	Possible configuration
Source preference selector	Input Selection that normally supplies the load	Source A	<ul style="list-style-type: none"> Source A Source B

7. Communication Port

The ATS is supplied with the following communication ports:

- Serial port is available with RS232 com. port and USB com. port on the front panel.
NOTE: the use of one port automatically excludes the other.
- Contact port on the rear panel.

Serial Ports: RS-232 & USB connectors

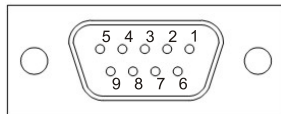

RS-232 connector



USB connector

PIN #	NAME	TYPE	SIGNAL
1			
2	TX	OUT	Serial line TX
3	RX	IN	Serial line RX
4			
5	GND	POWER	
6	+12V	POWER	
7			
8			
9			

PIN #	SIGNAL
1	VBUS
2	D-
3	D+
4	GND

NOTE: The utilization of the communication port is optional and it is not necessary for the normal function of the ATS.

Contact Outputs

The contact outputs consist of six (6) pins numbered from left to right (see fig. 1), which can be connected to an external monitoring system (such as a BMS) in order to monitor the operational status of the ATS.

The external equipment must be within the rating of the contacts

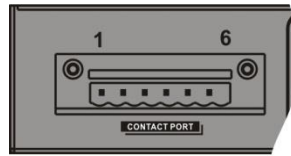

Fig. 1: Contacts Connector

The Contact Connector provides the following connections:

- Pin 1: Common contact.
- Pin 2: "Source B" active contact - pins 1 and 2 closed = output supplied by "Source B"
- Pin 3: "Source A" active contact - pins 1 and 3 closed = output supplied by "Source A"
- Pin 4: "Source A" status OK contact - pins 1 and 4 closed = "Source A" is present and normal
- Pin 5: "Source B" status OK contact - pins 1 and 5 closed = "Source B" is present and normal
- Pin 6: Status OK contact – pins 1 and 6 closed = ATS operation normal

The following diagram shows the contact configuration

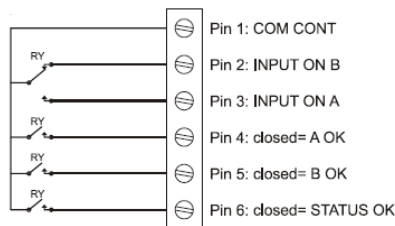

Fig. 2: Contact Connections

ATTENTION: Contact Connector pins are rated at a current of 8A and voltage of 250Vac.

8. Trouble Shooting

Problem	Possible Cause	Solution
The ATS with the mains voltage present, does not turn on. (The LEDs does not flash and no alarm sounds.)	Input plugs not connected	Connect the mains to the input plugs as indicated in the installation section.
	Input switch in "OFF" position	Turn the input switches "ON"
	Input power failure	Check that the mains voltage is present or check if the UPS supplying the ATS is on.
	Upstream Fuse or CB disconnected	Reset the CB or Fuse <u>Warning:</u> check that there is no overload or short-circuit at the output of the UPS.
The load is not powered.	Output sockets not connected	Connect the load to the output sockets
	10A Internal thermal protection device has tripped	The Internal protection will operate in the event of a short circuit or overload on one of the 10A output sockets. The thermal protection can be reset by pushing the button which will result in the power being reconnected to the load. Therefore prior to attempting a reset of the thermal protection, check the rating of the connected loads and determine if there is any overload. Then once reset, reconnect each load one at a time to ensure no problems exists.
No display or display provides incorrect information.	There is a power supply problem in the display.	Shut down the ATS completely and wait for a few seconds. Switch the ATS on again, if the problem persists, contact the nearest technical support centre.
The display is off but the load is powered.	There is a power supply problem in the display.	Contact the nearest technical support centre.

If there is any abnormal situation not listed above, please call PowerShield Service immediately for professional Technical Support

9. Technical Specifications

MODEL	PSATS 3K
INPUT	
Input Voltage	220/230/240 VAC
Input Voltage Range	180 - 258 VAC
Input Frequency	50 Hz/60 Hz
Maximum Input Current	16 A
OUTPUT	
Output Voltage	220/230/240 VAC
Maximum Output Current	10 A for IEC-C13 outlets 16 A for IEC-C19 outlet
CONNECTION	
Input	2 x IEC-C20 inlets
Output	8 x IEC-C13 1 x IEC-C19
Communication	USB, RS-232, AS400 or SNMP option
TRANSFER TIME	9-12ms (Typical)
PHYSICAL	
Dimensions, D X W X H (mm)	330 X 483 X 44
Net Weight (kgs)	5.0
ENVIRONMENT	
Operating Temperature	0-95 % RH @ -5°C- 45°C (non-condensing)

10. Appendix

Input Voltage and Frequency Thresholds

FUNCTION	DESCRIPTION	DEFAULT SETTING
Input voltage range for Source A	If Source A is the active source, when the input voltage is outside this range, the ATS will automatically switch to Source B.	180V – 265V
Return voltage point for Source A	When input voltage of Source A is back to normal, the ATS will switch back to Source A. (Setting is Source A as Preferred Power source)	Low: 190V High: 258V
Input voltage range for Source B	If Source B is the active power source, when the input voltage of source B is outside this range, the ATS will automatically switch to Source A.	180V – 265V
Return voltage point for Source B	When input voltage of Source B is back to normal, the ATS will switch back to Source B. (Setting is Source B as Preferred power source)	Low: 190V High : 258V
Input frequency for Source A	If Source A is the active source, when the input frequency of source A is outside this range, the ATS will automatically switch to Source B.	45Hz – 55Hz
Input frequency for Source B	If Source B is the active source, when the input frequency of source B is outside this range, the ATS will automatically switch to Source A.	45Hz – 55Hz

Default factory settings:

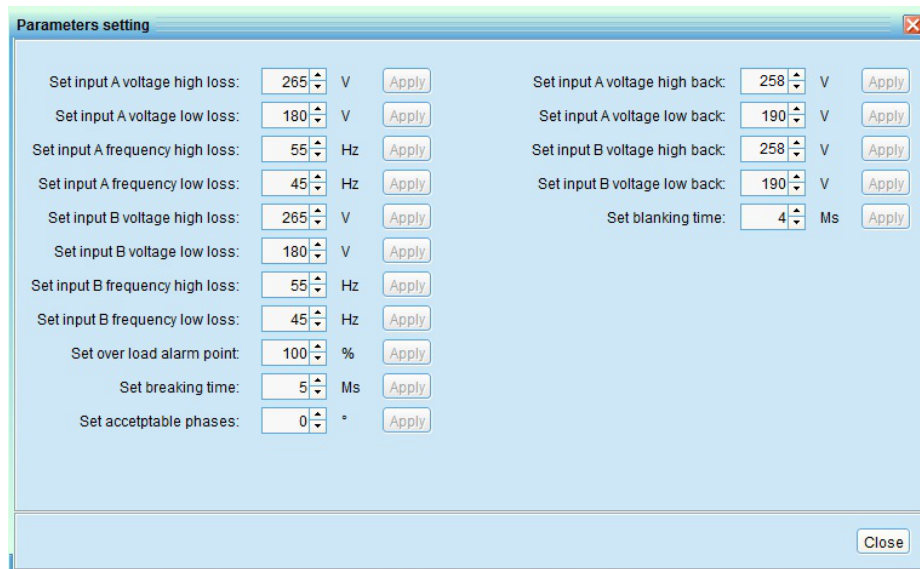

The screenshot shows a 'Parameters setting' window with the following default values:

- Set input A voltage high loss: 265 V
- Set input A voltage low loss: 180 V
- Set input A frequency high loss: 55 Hz
- Set input A frequency low loss: 45 Hz
- Set input B voltage high loss: 265 V
- Set input B voltage low loss: 180 V
- Set input B frequency high loss: 55 Hz
- Set input B frequency low loss: 45 Hz
- Set over load alarm point: 100 %
- Set breaking time: 5 Ms
- Set acceptable phases: 0 °
- Set input A voltage high back: 258 V
- Set input A voltage low back: 190 V
- Set input B voltage high back: 258 V
- Set input B voltage low back: 190 V
- Set blanking time: 4 Ms

11. WARRANTY

VERY IMPORTANT: Warranty Registration

In order to validate product warranty, it is essential that you register your product on line.
Please Visit PowerShield on line product warranty web page to register

www.powershield.com.au/product-registration.php

NOTE: For information about our Warranty Terms and Conditions, please visit our web site.
www.powershield.com.au under Support.

This user manual contains instructions relating to safety, installation, operation, maintenance and warranty of this product.

Please keep this manual in a safe place for future references

WARRANTY SERVICE PROCESS:

1. Review the problems discussed in the troubleshoot section of this manual to eliminate common problems.
2. Verify that no input/output circuit breaker have tripped. A tripped circuit breaker is the most common problem.
3. If the problem still persists, please call **1300-305-393** for technical support or fill in the RMA application form in PowerShield web page **www.powershield.com.au/rmaform/**

The following details are needed for warranty claims.

- Model number
- Serial number
- The date of purchase