

Surface Mounted Door Closers



We take the worry out of
protecting what's valuable to you.
Lockwood: *no worries*[®]

LOCKWOOD

ASSA ABLOY

25YEAR

**MECHANICAL
WARRANTY**

www.assaabloy.co.nz



**We take the worry out of
protecting what's valuable to you.**
Lockwood: *no worries*[®]

Contents

Lockwood Premium CAM Range



2616 CAM Action Door Closer with Slide Arm
page 6



2615 CAM Action Door Closer with Slide Arm
page 10

Lockwood Premium Rack and Pinion Range with Fully Formed Cover



7726DA Series Door Closer
page 18



7726SRDA Series Door Closer
page 20



7714DA Series Door Closer
page 22



7714SRDA Series Door Closer
page 24



2657 Series Door Closer
page 14



2024 Series Door Closer
page 26

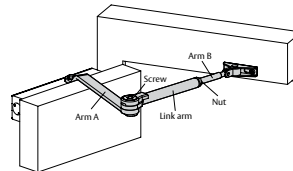

Standard Hold-Open Arm
page 29

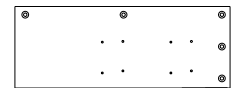

Standard Drop Plates
page 30

Lockwood Surface Mounted Door Closers



Designed and manufactured to exacting standards. These world recognised standards ensure the highest possible quality, efficiency and reliable performance.

All models (except hold-open) are tested and approved on fire doors in accordance with Australian Standard AS1905:1:2005 Fire Resistant Doorsets.

New multi functional designs offer the specifier, stockist or the installer outstanding versatility and low inventory levels.

Effective door installation requires that the door and frame be of sufficient strength or reinforced to ensure secure anchorage of the door closer unit.

A door fitted with a door closer must be hung on good quality, aligned hinges so it swings freely without bias in both directions.

The closed door must be clear in the door frame and when a lock is fitted the latch bolt must engage freely within the strike.

When specifying manually operated door closers the following should be considered: door size, in particular width of door; door weight; type of installation; environmental conditions; location of door; operation frequency of door; the people using the door.

Door size and the pressure exerted on the surface area of the door due to wind gusts or air conditioning and the spring strength required to

hold or close the door against this pressure must be considered along with the ability of the user to exert the force necessary to push or pull the door open. The location of door furniture will influence the leverage available to the person opening the door.

About Lockwood

Lockwood is the leading brand in the Australian locking industry. With an established reputation for high quality products, this iconic brand provides a wide range of locking solutions to residential housing, commercial building and industrial application markets. Lockwood is supported by an extensive distribution and after-sales support network. Our customers include retailers, architects, trade and industrial personnel, locksmiths and security dealers.

About ASSA ABLOY

ASSA ABLOY is the global leader in door opening solutions, dedicated to satisfying end-user needs for security, safety and convenience.

ASSA ABLOY is represented in all major regions, in both mature and emerging markets, with leading positions in Australia, Europe and North America.



The Lockwood 25 Year Mechanical Warranty

Our belief that we manufacture the finest premium products available in today's market place is backed by the Lockwood 25 Year Mechanical Warranty, ensuring that Lockwood continues to keep Australians safe by delivering security and peace of mind.

For warranty terms and conditions, please visit www.lockweb.com.au or call 1300WARRANTY

Door Closer Selection

Selection of door closer size is judged in two ways.

1. Does the door closer have the strength to effectively close the door against unexpected air pressures?
2. Is the door closer oversized for the application and therefore affecting the ease of operation?

Efficiency of the door closer also has a major bearing on ease of operation. For optimum performance it is essential that a highly efficient door closer of a correct size is selected.

The use of spring strength adjustability, which allows fine tuning of strength on site, has simplified this task but not removed all of the guesswork. With more architects and engineers becoming conscious of the problems caused by incorrect selection of door closer strength, it has become the responsibility of manufacturers to provide better technical information, such as closing torque and efficiency of their products.

The following chart has been produced to cover most conditions. If you have an unusual application which you feel requires special consideration, please forward all relevant information to your local office and we will be happy to advise the best door control for your application.

Fire doors and pressurised stairwells pose significant challenges in ensuring closing and latching of fire doors. The problems are created by differential air pressures resulting from air conditioning systems on either side of the door. To achieve complete fire safety, fire doors must latch securely at all times. If this performance is not achieved the stairwell may be unsafe, and in the event of fire, loss of life and property may occur. Correct selection of door hardware is of paramount importance in ensuring that the appropriate operating standards are met.

Fire doors which open into a pressurised stairwell must meet the following criteria:

- the door must close against a pressure differential between the air conditioned floor area and non-air conditioned stairwell;
- the door must latch securely every time it closes;
- the door must be able to be opened with a force not exceeding 110N when the stairwell is pressurised; and
- the door must be protected from damage when it is opened by means of a back check action which is built into the door closer.

Note

- Always round up to the next door width (i.e. for 870 mm door use 950 mm).
- If parallel arm installation, then use next door width (i.e. for 830 mm door use 950 mm).
- For internal doors deduct 200 mm from actual door width (i.e. for 1250 mm internal door use 1050 mm).
- This chart is based on normal climatic conditions (i.e. pressure differential of 30Pa or wind of 15 knots).
- If more severe conditions are expected then use the next door width or contact customer service for more information (refer back page).
- When specifying parallel arm and slide rail functions, allowance should be made for the following power loss:

Parallel Arm Mounting

Approximately 20% power loss

Slide Rail Mounting

Approximately 30% power loss

Power Selection Chart

This chart below will be most useful in selecting the correct door closer. Simply identify the dimensions of the appropriate door and select the recommended door closer.

The chart is intended as a guide only and as such the following variations should be taken into account when making your selection:

- Environmental factors such as the effect of wind or air conditioning pressures.
- An unsheltered external door is a door on which prevailing wind gusts will directly produce a "sail area" effect.
- A sheltered external door is a doorway which is protected by a wind break or wall which acts as a barrier against direct wind gusts.

Door Closer Selection Chart

Recommended Door Width	Door Weight (kg) Max	Closer Power Size	Closing Torque (Nm)
750mm	20	1	9 - <13
850mm	40	2	13 - <18
950mm	60	3	18 - <26
1100mm	80	4	26 - <37
1250mm	100	5	37 - <54
1400mm	120	6	54 - <87
1600mm	160	7	87 - <140

2616 CAM Action Door Closer with Slide Arm



The Lockwood 2616 CAM Action Door Closer is a premium, high quality door closing device. When opening a door fitted with a Lockwood 2616 CAM Action Door Closer, the force required is less than that of a rack and pinion type door closer and continues to decrease through the opening arc.

This aesthetically appealing, narrow profile CAM Action Door Closer is suited for public and commercial applications where children, the elderly and the disabled are likely to be using the door.

The Lockwood 2616 is light to open, but its adjustable closing force is high enough for heavy duty applications.

One model (2616) covers right hand and left hand applications, pull side/ push side applications and also features an adjustable arm height.

The 2615 has a very high efficiency of 70% - 80%

Specifications

Power	EN adjustable 1 to 6.
Back check (BC)	Adjustable.
Hold Open	Adjustable. Hold-open can be set at any angle up to 120° of opening.
Handing	Non-handed. Suitable for left or right hand doors.
Cover	Formed metal cover.
Materials	Cast aluminium body manufactured from high-performance silicon alloy.
Mechanism	CAM action.
Mounting	Pull side, push side and over-door mounting.
Valves	Two pressure relief valves are a standard feature to protect against abuse.
Delayed Action	Adjustable.
Closing Speed	Adjustable.
Latching Speed	Adjustable.

Ordering Information

Model	Part Numbers	Finishes
Slide Arm Closer	2616DASSS	Satin Stainless Steel
	2616DAPB	Brass
	2616DASIL	Silver
Hold Open Device	2616-152	
Opening Damper	2616-153	
Push Side Angle Plate	2616-104SIL	Silver
Mounting Plate	2616-180SIL	Silver

Standards and Compliance



The Lockwood 2616 series closer has been successfully tested up to four hours (depending on type of doorset) on fire door assemblies in accordance with Australian Standard AS1905.1:2005, Part: Fire Resistant Door sets.

Note: Hold open option is not approved on any fire door.



Disabled Access Australian Standard (AS1428.1) Design for access and mobility.

2616 CAM Action Door Closer with Slide Arm

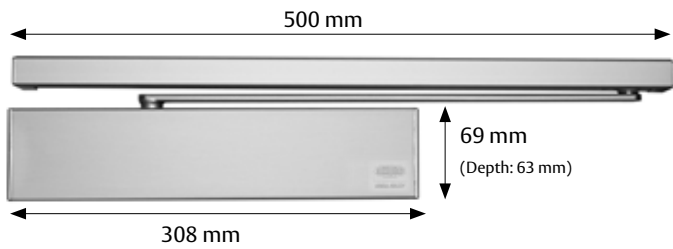

Movement Curve

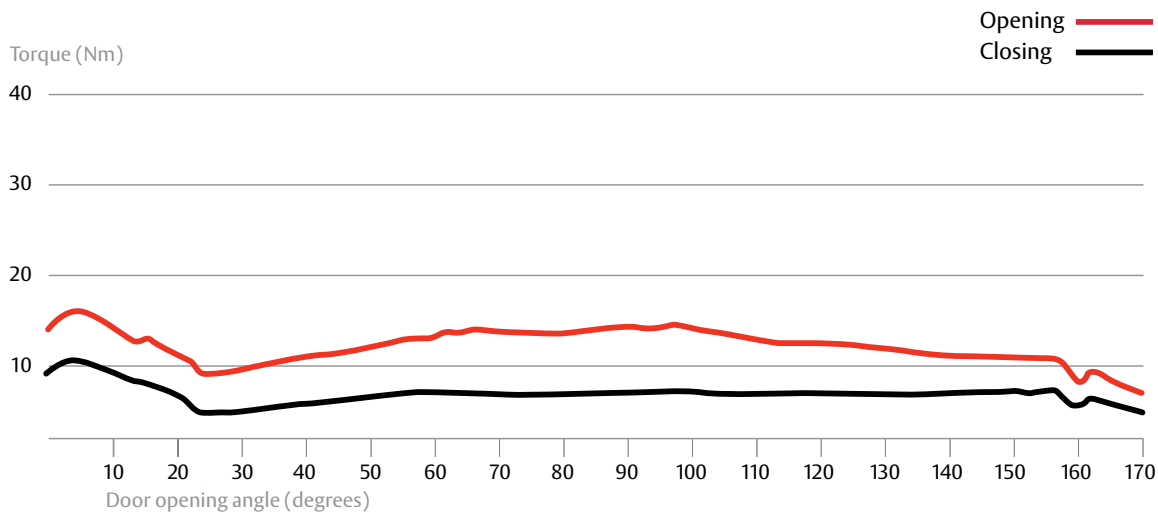

Note: Movement curve represents approximate forces required to operate a size 1 door closer. The illustration is an approximation based on one set of parameters. Any change to these parameters will result in a variation of performance.

Door Closer Selection Chart

Recommended Door Width	Door Weight (kg) Max	Closer Power Size	Closing Torque (Nm)
750mm	20	1	9 - <13
850mm	40	2	13 - <18
950mm	60	3	18 - <26
1100mm	80	4	26 - <37
1250mm	100	5	37 - <54
1400mm	120	6	54 - <87
1600mm	160	7	87 - <140

2616 CAM Action Door Closer with Slide Arm

Pull Side - Standard Mounting

Non hold-open permits door opening to 170°, and 160° when opening damper is used. When hold-open device is installed, the opening angle (hold-open) can be set to a maximum of 120°.

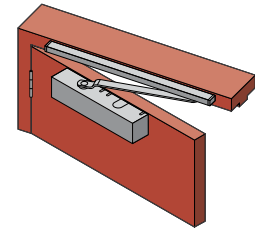
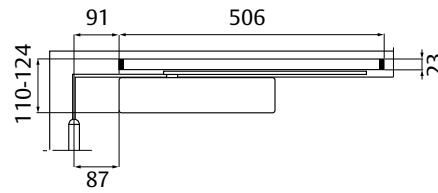
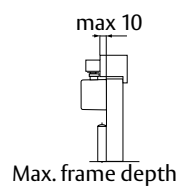

Push Side - Standard Mounting

Non hold-open permits door opening to 120°, and 110° when opening damper is used. When hold-open device is installed, the opening angle (hold-open) can be set to a maximum of 120°.

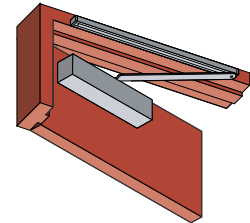
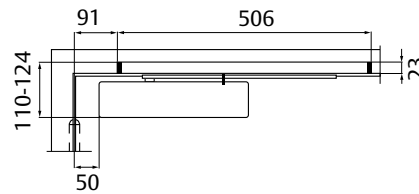
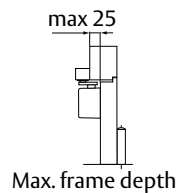

Push Side - Over-Door Mounting

Non hold-open permits door opening to 120°, and 110° when opening damper is used. When hold-open device is installed, the opening angle (hold-open) can be set to a maximum of 120°.

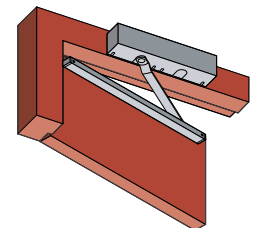
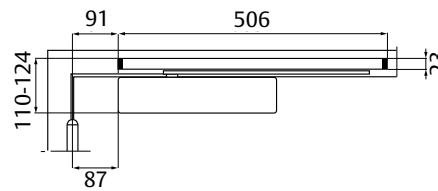
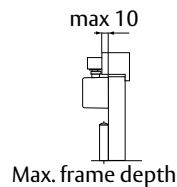

Pull Side - Door Mounting

Non hold-open permits door opening to 170°, and 160° when opening damper is used. When hold-open device is installed, the opening angle (hold-open) can be set to a minimum of 120°.

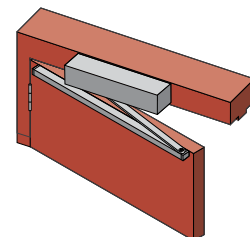
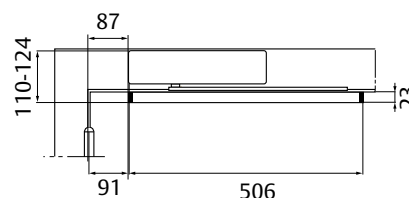
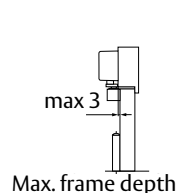

2616 CAM Action Door Closer with Slide Arm

Angle Plate

Part Number 2616-104SIL

Allows the side rail to be installed below the door jamb. Required when the face of the door jamb exceeds 25 mm from the face of the door in the closed position.

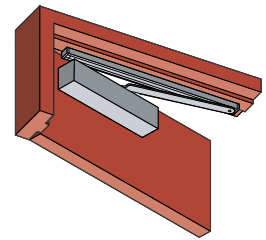
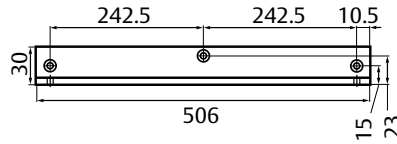
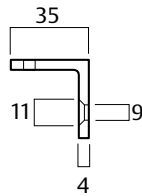

Mounting Plate

Part Number 2616-180SIL

For use on glazed doors with small top rail, this plate allows the closer to project below the top rail, at the same time concealing the back of the closer.

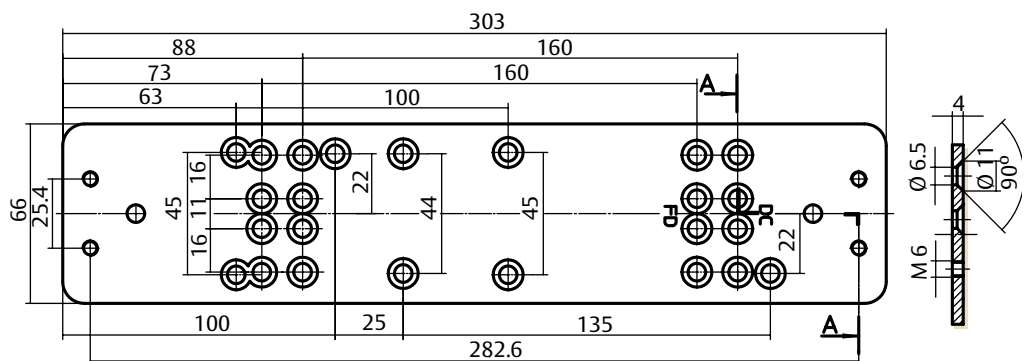

Adjustment

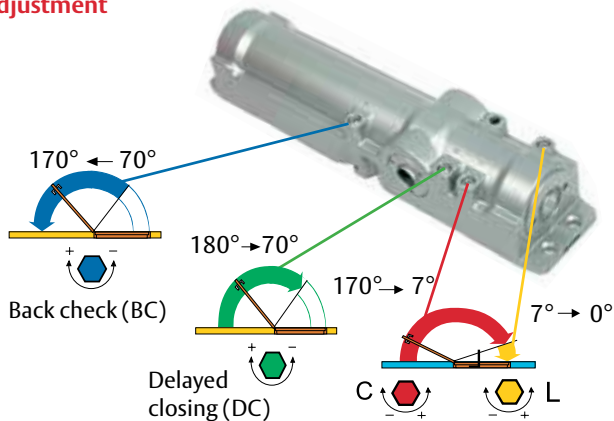

Adjustment

Adjusting the Arm Height

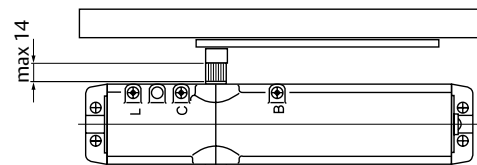

The arm height can be adjusted (by a maximum of 14 mm) by moving the grooved spindle in a vertical direction.

Opening Damper

Part Number 2616-153

Max. damping angle -110°
Designed to brake the door before hitting the door stopper.
Required for fire door applications.



Hold Open Device

Part Number 2616-152

Adjustable hold-open force
Max. hold-open angle -110°



2615 CAM Action Door Closer with Slide Arm



The Lockwood 2615 Series is a non-handed CAM Action Door Closer.

Due to the CAM design this premium door closer is light to open but still strong enough to close a door.

The Lockwood 2615 Door Closer can be adjusted to meet the requirements of a light door opening resistance and is ideal for both interior and exterior doors.

The Lockwood 2615 is light to open, but its adjustable closing force is high enough for heavy duty applications.

For disabled toilet applications where a breakout feature is required, the double action of the mechanism allows the door to be operated in the opposite direction for easy access into the room.

One model (2615) covers right hand and left hand applications, pull side/push side applications and also features an adjustable arm height.

The 2615 has a very high efficiency of 70% - 80%

Specifications

Power	EN adjustable 1 to 5.
Back check (BC)	Adjustable.
Hold Open	Adjustable. Hold-open can be set at any angle up to 120° of opening.
Handing	Non-handed. Suitable for left or right hand doors.
Cover	Formed metal cover.
Materials	Cast aluminium body manufactured from high-performance silicon alloy.
Mechanism	CAM action.
Mounting	Pull side, push side and over-door mounting.
Valves	Two pressure relief valves are a standard feature to protect against abuse.
Delayed Action	Adjustable.
Closing Speed	Adjustable.
Latching Speed	Adjustable.

Ordering Information

Model	Part Number	Finish
Slide Arm Closer	2615DASSS	Satin Stainless Steel
	2615DAPB	Brass
	2615DASIL	Silver
Hold Open Device	2616-152	
Opening Damper	2616-153	
Push Side Angle Plate	2616-104SIL	Silver
Mounting Plate	2615-180SIL	Silver

Standards and Compliance



The Lockwood 2615 series closer has been successfully tested up to four hours (depending on type of doorset) on fire door assemblies in accordance with Australian Standard AS1905.1:2005, Part: Fire Resistant Door sets.

Note: Hold open option is not approved on any fire door.



Disabled Access Australian Standard (AS1428.1) Design for access and mobility.

2615 CAM Action Door Closer with Slide Arm

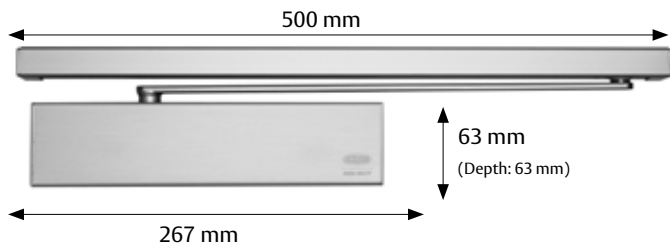

Movement Curve

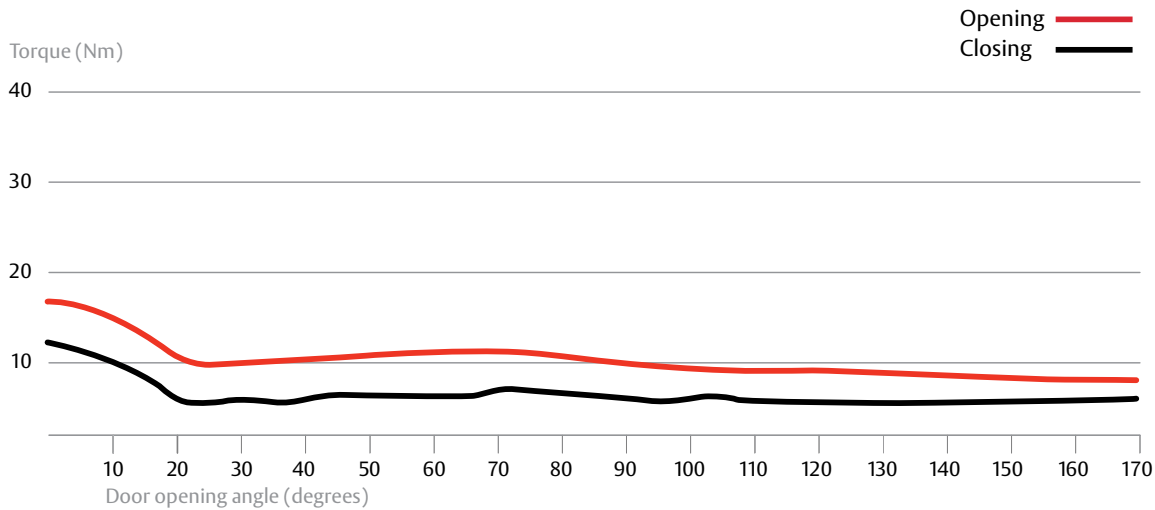

Note: Movement curve represents approximate forces required to operate a size 1 door closer. The illustration is an approximation based on one set of parameters. Any change to these parameters will result in a variation of performance.

Door Closer Selection Chart

Recommended Door Width	Door Weight (kg) Max	Closer Power Size	Closing Torque (Nm)
750mm	20	1	9 - <13
850mm	40	2	13 - <18
950mm	60	3	18 - <26
1100mm	80	4	26 - <37
1250mm	100	5	37 - <54
1400mm	120	6	54 - <87
1600mm	160	7	87 - <140

2615 CAM Action Door Closer with Slide Arm

Pull Side - Standard Mounting

Non hold-open permits door opening to 170°, and 160° when opening damper is used. When hold-open device is installed, the opening angle (hold-open) can be set to a maximum of 120°.

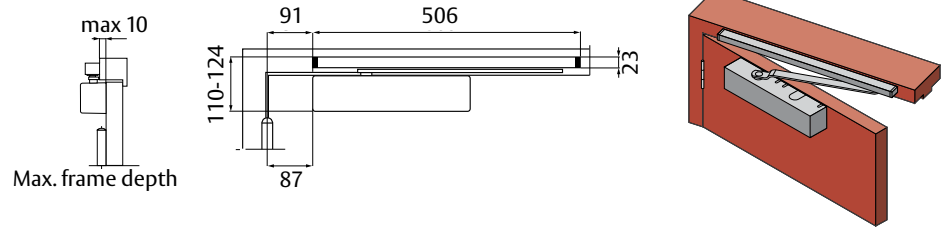

Push Side - Standard Mounting

Non hold-open permits door opening to 120°, and 110° when opening damper is used. When hold-open device is installed, the opening angle (hold-open) can be set to a maximum of 120°.

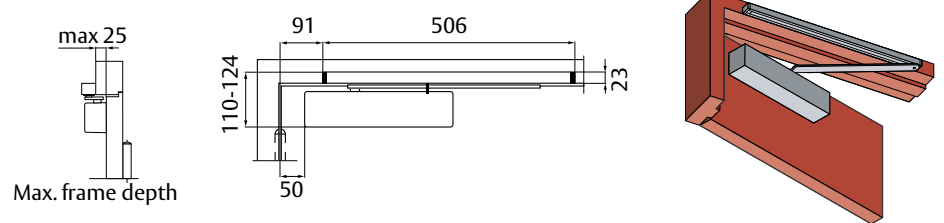

Push Side - Over-Door Mounting

Non hold-open permits door opening to 120°, and 110° when opening damper is used. When hold-open device is installed, the opening angle (hold-open) can be set to a maximum of 120°.

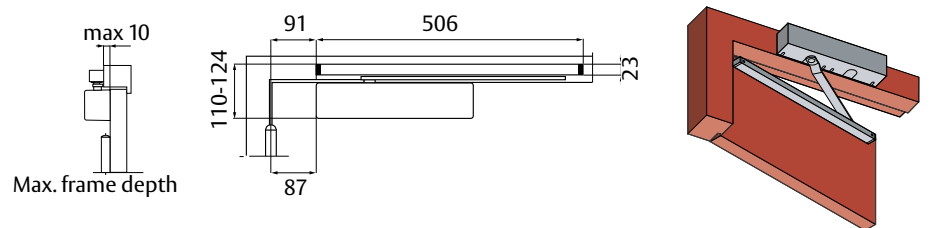

Pull Side - Door Mounting

Non hold-open permits door opening to 170°, and 160° when opening damper is used. When hold-open device is installed, the opening angle (hold-open) can be set to a minimum of 120°.

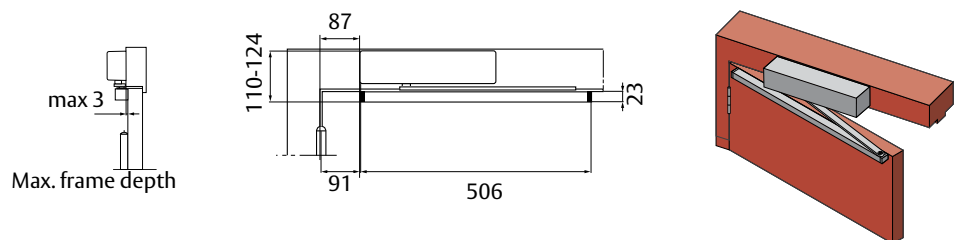

2615 CAM Action Door Closer with Slide Arm

Angle Plate

Part Number 2616-104SIL

Allows the side rail to be installed below the door jamb. Required when the face of the door jamb exceeds 25 mm from the face of the door in the closed position.

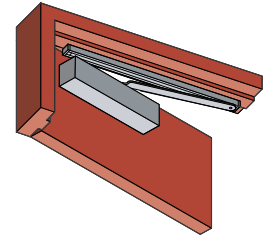
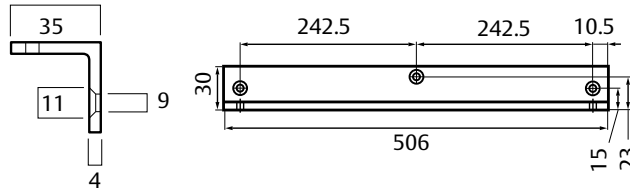

Mounting Plate

Part Number 2615-180SIL

For use on glazed doors with small top rail, this plate allows the closer to project below the top rail, at the same time concealing the back of the closer to enhance the appearance as seen through the glass.

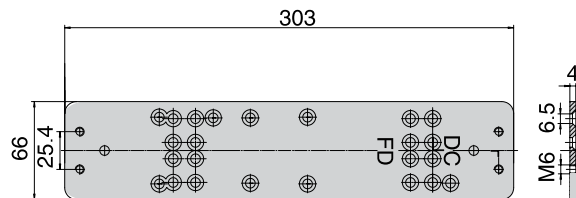

Adjustment

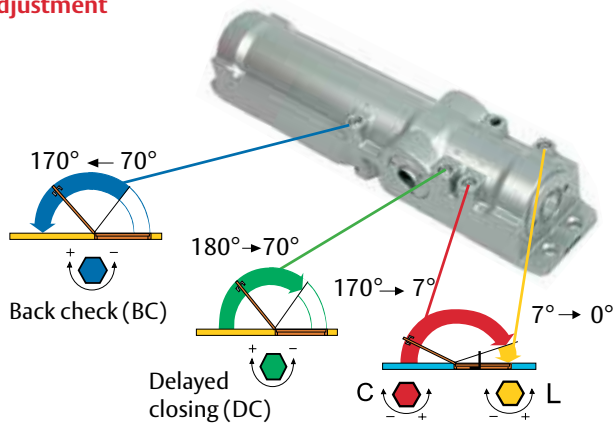

Adjustment

Adjusting the Arm Height

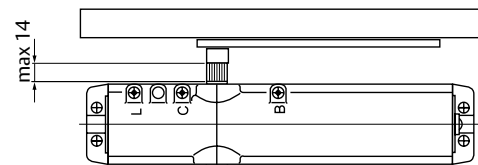

The arm height can be adjusted (by a maximum of 14 mm) by moving the grooved spindle in a vertical direction.

Opening Damper

Part Number 2616-153

Max. damping angle -110°
Designed to brake the door before hitting the door stopper.
Required for fire door applications.



Hold Open Device

Part Number 2616-152

Adjustable hold-open force
Max. hold-open angle -110°



2657 Heavy Duty Series Door Closer



The Lockwood 2657 Heavy Duty Series is suitable for use on internal and external doors and is an ideal solution for extremely heavy doors. Maximum door weight 160kg and door leaf width 1600mm with standard arm installation.

Specifications

Power	EN adjustable 5 to 7.
Back check (BC)	Adjustable.
Handing	Non-handed. Suitable for left or right hand doors.
Cover	Fully formed metal.
Materials	Die-cast aluminium body manufactured from high performance silicon alloy.
Mechanism	Rack and pinion design.
Mounting	Regular and over-door mounting.
Valves	Separate adjusting valves for closing and latching speed. Two pressure relief valves to protect against abuse.
Operating Temp	-35°C to +45°C

Ordering Information

Part Number	Finish
2657SIL	Silver

Note: Parallel arm (push side) is not available on this model.

2657 Heavy Duty Series Door Closer



2657 Standard Arm

Closer installed on pull side of door. This mounting position permits opening of 180°.

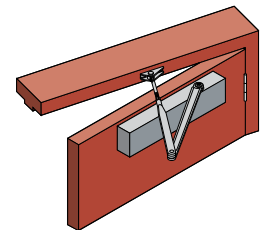
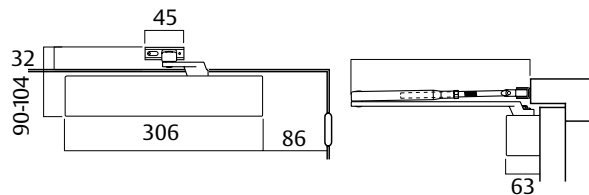

2657 Over Door Mounting

Closer installed on push side of door and top rail where conditions do not allow parallel mounting. This mounting position permits opening of 180°.

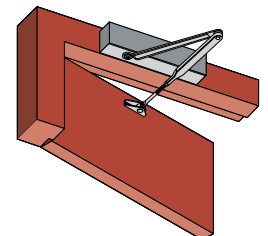
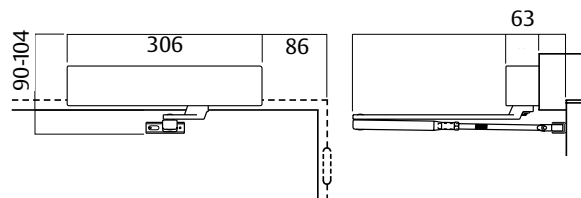

Adjustment

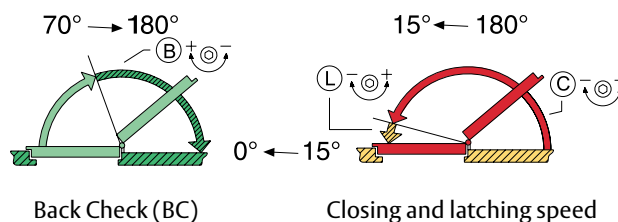
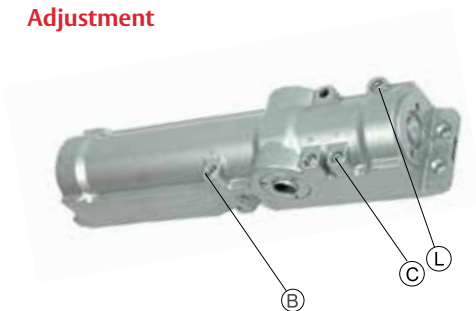

Rack and Pinion Hydraulic Door Closer Range

Features and Specifications

Handing

Lockwood Door Closers are non-handed, therefore final assemblies are suitable for clockwise or anticlockwise opening doors.

Back Check

Back check is a standard feature on all models in this series. Back check cushions or slows the opening movement of the door prior to reaching the final open position.

Back check intensity is adjustable to allow for door size, door weight and closing power. It is mandatory on all fire doors.

Door Stops

Floor or wall mounted door stops should be fitted to prevent possible damage to the door unit or surrounds where a door may be subject to violent opening; to stop a door from being forced past the position where the arms are fully extended; or to stop a door at a specific position to clear feature walls, glass panels, furniture, etc.

Delayed Action

The delayed action is an independent valve and can either be adjusted as part of the closing sequence or independently adjusted for delayed action.

Such doors are particularly suitable for use by the disabled, the aged and people with prams or trolleys.

Sequence Selectors

When a pair of rebated doors are fitted with door closers it is essential that the doors close in their correct sequence. This closing sequence is achieved by the installation of a sequence selector.

Materials

Extruded aluminium body with hard anodised coating. Alloy steel rack and pinion mechanism operated by silicon chrome alloy steel springs and forged steel arms.

Fire Test

Approved on fire door assemblies up to 4 hours, in accordance with Australian Standards AS1905 Part 1 – Fire Resistant Doors 2005.

Standard Hold-Open

The hold-open device is located on the link arm and is activated by a cam. The position of the cam is adjustable to suit the desired hold-open position up to 150°.

The operation of the hold-open device does not limit the angle to which the door may be opened, as the door may be pushed past the hold-open position without effecting its operation.

A firm push or pull on the door will release the hold-open device.

Slide Rail Hold-Open

Hold-open is a standard feature for all slide arm door closers. It can be adjusted or disabled at any angle of the open arc.

Note: Hold open option is not approved on any fire door.

Pinion Needle Bearings

High grade pinion with precision needle bearings increases efficiency and minimises wear ensuring a prolonged operational life.

Independently Adjustable

Hydraulic Valves
Back check.
Latching speed.
Closing speed.

Spring

Highest grade silicon chrome steel springs provide smooth action and long life.

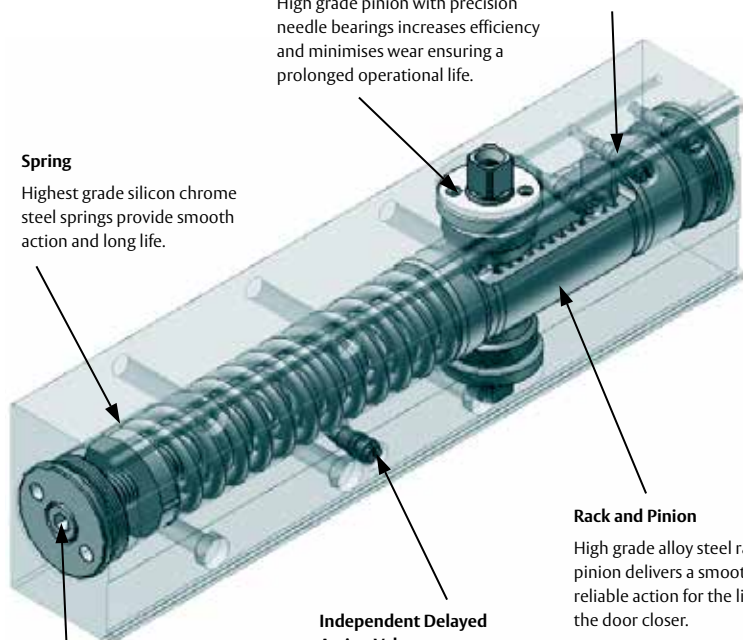

Overload Protection

Pressure relief valves are fitted to all units to prevent closer damage in the event of excessive force.

Power Adjustment Screw

The spring strength of the unit can be adjusted to the requirements of a specific door simply by turning the adjustment screw with the hex key supplied.

Independent Delayed Action Valve

The delayed action is an independent valve and can be adjusted as part of the closing sequence or independently adjusted for delayed action.

Rack and Pinion

High grade alloy steel rack and pinion delivers a smooth and reliable action for the life of the door closer.

Rack and Pinion Hydraulic Door Closer Range

Standard Features

Primary Lock	7726DA Premium	7714 DA Premium	2024
Materials			
Extruded Aluminium body with hard anodised coating	✓	✓	
Alloy Steel Rack and Pinion Mechanism	✓	✓	✓
Silicon Chrome Steel Alloy Springs	✓	✓	✓
Forged Steel Arms	✓	✓	✓
Fully Formed Metal Box Cover	✓	✓	
Clip-on Cover			
High Grade Pinion Needle Bearings	✓	✓	✓
Power Adjustment			
Adjustable Power	✓	✓	
Adjustable Power - Position			✓
Power Size			
Power Size 1	✓	✓	
Power Size 2	✓	✓	✓
Power Size 3	✓	✓	✓
Power Size 4	✓	✓	✓
Power Size 5	✓		
Power Size 6	✓		
Features			
Back Check	✓	✓	✓
Delayed Action	✓	✓	
Non-Handed	✓	✓	✓
Overload Protection	✓	✓	✓
Standard Arm	✓	✓	✓
Slide Arm	✓	✓	
Over Door Mounting	✓	✓	✓
Standard Hold-Open	✓	✓	✓
Slide Arm Hold-Open	✓	✓	
Fire Rated	✓	✓	✓
Finishes			
Satin Stainless Steel	✓	✓	
Polished Stainless Steel	✓	✓	
Silver	✓	✓	✓
Gold	✓	✓	

7726DA Series Premium Range Surface Mounted Door Closer



Rack and pinion adjustable power door closer suitable for architectural and commercial applications.

Specifications

Power	EN adjustable 2 to 6.
Back check (BC)	Adjustable.
Hold Open	Adjustable. Hold-open can be set at any angle up to 150° of opening.
Handing	Non-handed. Suitable for left or right hand doors.
Cover	Fully formed metal.
Materials	Extruded aluminium body manufactured from high-performance silicon alloy.
Mechanism	Rack and pinion design.
Mounting	Regular, parallel and over-door mounting.
Valves	Adjustable closing and latching speed valves with overload protection.
Delayed Action	Adjustable.

Ordering Information

Model	Part Numbers	Finishes
Standard Arm	7726DASSS	Satin Stainless Steel
	7726DAPSS	Polished Stainless Steel
	7726DASIL	Silver
Hold-Open	7726HDASSS	Satin Stainless Steel
	7726HDAPSS	Polished Stainless Steel
	7726HDASIL	Silver

Other finishes available on request

Standards and Compliance



The Lockwood 7726DA series closer has been successfully tested up to four hours (depending on type of doorset) on fire door assemblies in accordance with Australian Standard AS1905.1:2005, Part: Fire Resistant Door sets.

Note: Hold open option is not approved on any fire door.

7726DA Series Premium Range Surface Mounted Door Closer

7726DA Standard Arm

Part Numbers	Description
7726DA	Non hold-open
7726HDA	Hold-open

Closer installed on pull side of door. This mounting position permits opening of 180°.

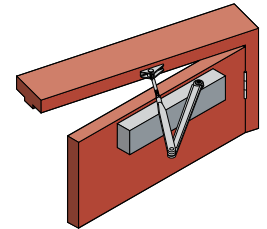
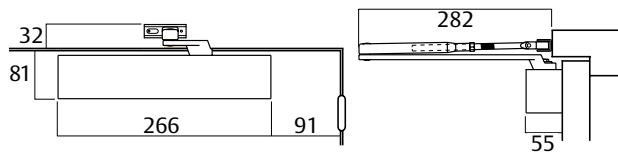

7726DA Parallel Arm

Part Numbers	Description
7726DA	Non hold-open
7726HDA	Hold-open

Closer installed on push side of door. This mounting position permits opening of 180°.

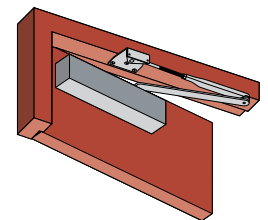
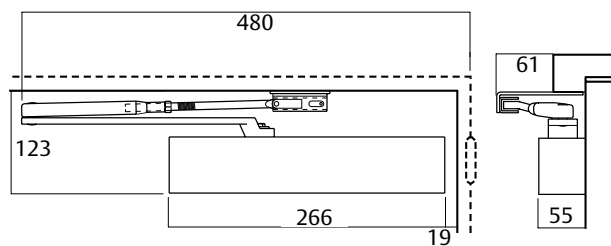

7726DA Over Door Mounting

Part Numbers	Description
7726DA	Non hold-open
7726HDA	Hold-open

Closer installed on push side of door and top rail where conditions do not allow parallel mounting. This mounting position permits opening of 180°.

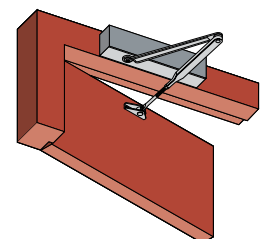
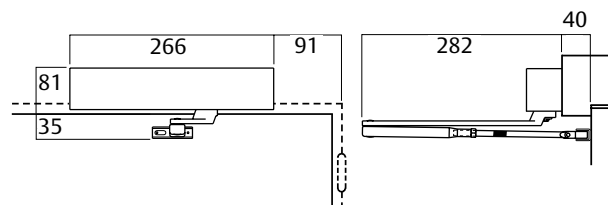

7726SRDA Series Premium Range Surface Mounted Door Closer



The Slide Arm Series permit smoother opening by way of reducing power as the door opens. Ideally suited for schools, hospitals or doors where children, disabled or the aged may enter.

Specifications

Power	EN adjustable 1 to 5.
Back check (BC)	Adjustable.
Hold Open	Adjustable. Hold-open can be set at any angle up to 130° of opening.
Handing	Non-handed. Suitable for left or right hand doors.
Cover	Fully formed metal.
Materials	Extruded aluminium body manufactured from high-performance silicon alloy.
Mechanism	Rack and pinion design.
Mounting	Regular, parallel and over-door mounting.
Valves	Adjustable closing and latching speed valves with overload protection.
Delayed Action	Adjustable.

Ordering Information

Model	Part Numbers	Finishes
Slide Arm	7726SRDASSS	Satin Stainless Steel
	7726SRDAPSS	Polished Stainless Steel
	7726SRDASIL	Silver

Other finishes available on request

Standards and Compliance



The Lockwood 7726SRDA series closer has been successfully tested up to four hours (depending on type of doorset) on fire door assemblies in accordance with Australian Standard AS1905.1:2005, Part: Fire Resistant Door sets.

Note: Hold open option is not approved on any fire door.

7726SRDA Series Premium Range Surface Mounted Door Closer

7726SRDA Slide Arm Pull Side

Part Numbers

7726SRDA

Closer installed on pull side of door. This mounting position permits opening of 130°.

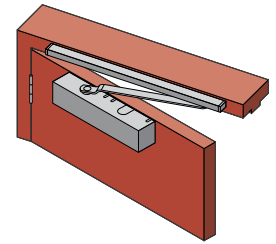
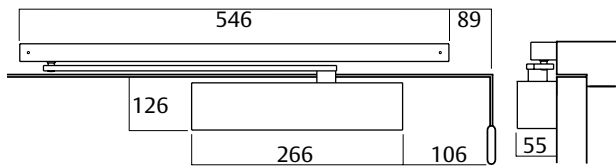

7726SRDA Slide Arm Push Side

Part Numbers

7726SRDA

Closer installed on push side of door. This mounting position permits opening of 130°.

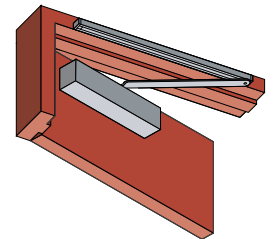
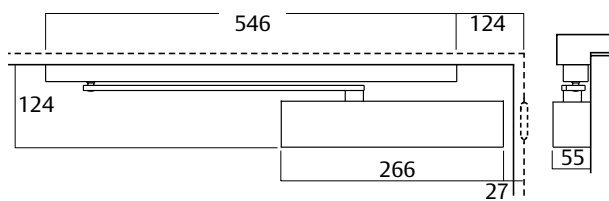

7726SRDA Slide Arm Over Door Mounting Push Side

Part Numbers

7726SRDA

Closer installed on push side of door and top rail where conditions do not allow parallel mounting. This mounting position permits opening of 130°.

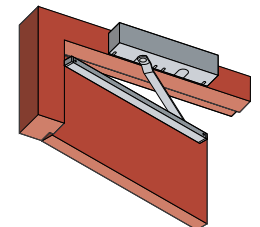
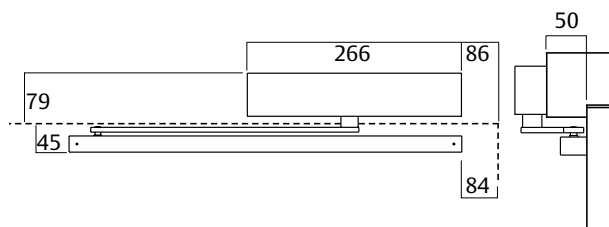

7714DA Series Premium Range Surface Mounted Door Closer



Rack and pinion adjustable power door closer suitable for architectural and commercial applications.

Specifications

Power	EN adjustable 1 to 4.
Back check (BC)	Adjustable.
Hold Open	Adjustable. Hold-open can be set at any angle up to 150° of opening.
Handing	Non-handed. Suitable for left or right hand doors.
Cover	Fully formed metal.
Materials	Extruded aluminium body manufactured from high-performance silicon alloy.
Mechanism	Rack and pinion design.
Mounting	Regular, parallel and over-door mounting.
Valves	Adjustable closing and latching speed valves with overload protection.
Delayed Action	Adjustable.

Ordering Information

Model	Part Numbers	Finishes
Standard Arm	7714DASSS	Satin Stainless Steel
	7714DAPSS	Polished Stainless Steel
	7714DASIL	Silver
Hold-Open	7714HDASSS	Satin Stainless Steel
	7714HDAPSS	Polished Stainless Steel
	7714HDASIL	Silver

Other finishes available upon request

Standards and Compliance



The Lockwood 7714DA series closer has been successfully tested up to four hours (depending on type of doorset) on fire door assemblies in accordance with Australian Standard AS1905.1:2005, Part: Fire Resistant Door sets.

Note: Hold open option is not approved on any fire door.

7714DA Series Door Closer

7714DA Standard Arm

Part Numbers	Description
7714DA	Non hold-open
7714HDA	Hold-open

Closer installed on pull side of door. This mounting position permits opening of 180°.

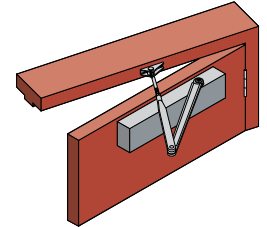
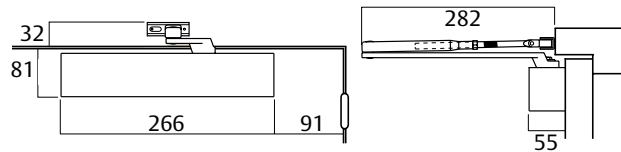

7714DA Parallel Arm

Part Numbers	Description
7714DA	Non hold-open
7714HDA	Hold-open

Closer installed on push side of door. This mounting position permits opening of 180°.

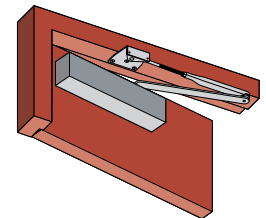
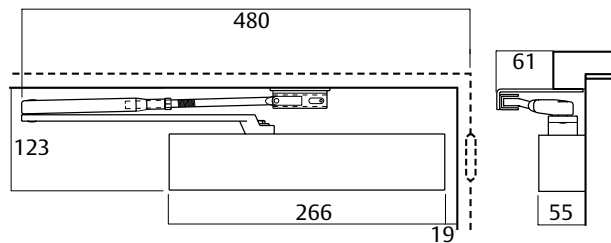

7714DA Over Door Mounting

Part Numbers	Description
7714DA	Non hold-open
7714HDA	Hold-open

Closer installed on push side of door and top rail where conditions do not allow parallel mounting. This mounting position permits opening of 180°.

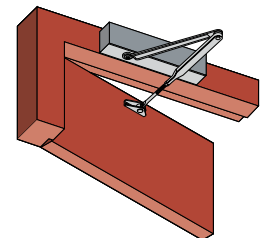
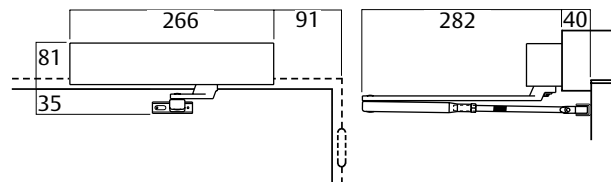

7714SRDA Series Premium Range Surface Mounted Door Closer



The Slide Arm Series permits smoother opening by way of reducing power as the door opens. Ideally suited for schools, hospitals or doors where children, disabled or the aged may enter.

Specifications

Power	EN adjustable 1 to 3.
Back check (BC)	Adjustable.
Hold Open	Adjustable. Hold-open can be set at any angle up to 130° of opening.
Handing	Non-handed. Suitable for left or right hand doors.
Cover	Fully formed metal.
Materials	Extruded aluminium body manufactured from high-performance silicon alloy.
Mechanism	Rack and pinion design.
Mounting	Regular and over-door mounting.
Valves	Adjustable closing and latching speed valves with overload protection.
Delayed Action	Adjustable.

Product Details

Model	Part Numbers	Finishes
Slide Arm	7714SRDASSS	Satin Stainless Steel
	7714SRDAPSS	Polished Stainless Steel
	7714SRDASIL	Silver

Other finishes available upon request

Standards and Compliance



The Lockwood 7714SRDA series closer has been successfully tested up to four hours (depending on type of doorset) on fire door assemblies in accordance with Australian Standard AS1905.1:2005, Part: Fire Resistant Door sets.

Note: Hold open option is not approved on any fire door.



Disabled Access Australian Standard (AS1428.1) Design for access and mobility.

7714SRDA Series Door Closer

7714SRDA Slide Arm Pull Side

Part Numbers

7714SRDA

Closer installed on pull side of door. This mounting position permits opening of 130°

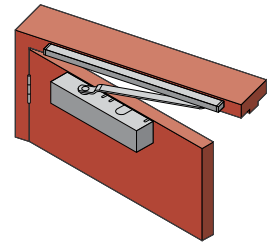
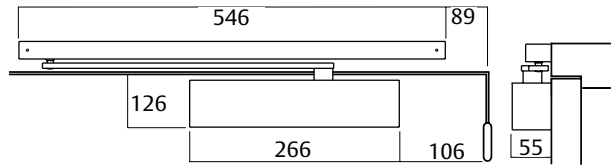

7714SRDA Slide Arm Push Side

Part Numbers

7714SRDA

Closer installed on push side of door. This mounting position permits opening of 115°.

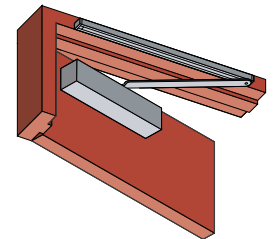
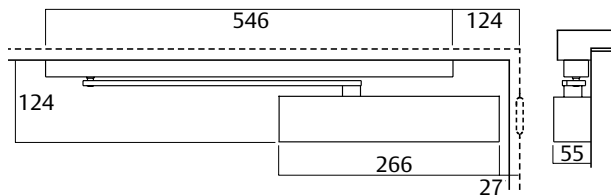

7714SRDA Slide Arm Over Door Mounting Push Side

Part Numbers

7714SRDA

Closer installed on push side of door and top rail where conditions do not allow parallel mounting. This mounting position permits opening of 115°.

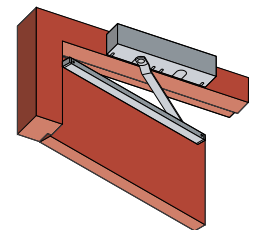
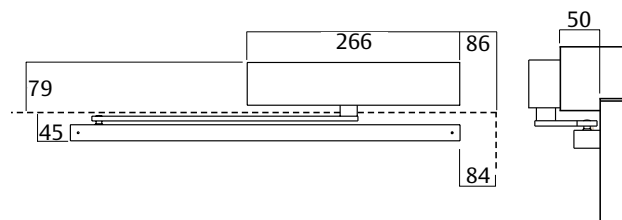

2024 Series Door Closer



The Lockwood range of economy door closers is particularly quick and easy to install on most applications, ideally suitable where cost is a high priority. Multi position mounting template enables adjustment on site to meet most conditions also low stock holding as one model will cover 3 power sizes. Suitable for doors up to 1100 mm in width.

All products include parallel arm bracket; multi strength mounting (one model covers size 2, 3 and 4) ; parallel arm size 2 and 3.

Power Selection

The power of the door closer is altered by adjusting the position of the door closer body on the mounting template.

Specifications

Adjustment	Independent valves control closing and latching speeds which can be readily adjusted on site when required.
Power	EN power selectable 2 to 4.
Back check (BC)	Available in this series, specify BC if required. Back check cushions or slows the door prior to reaching final opening position.
Finishes	Silver backed enamel.
Handing	Non-handed. Suitable for left or right hand doors.
Hold-Open	Available in this series, specify HO. Hold-open option is not approved on any fire door.
Materials	High purity die cast aluminium housing with hardened steel rack pinion mechanism.
Mechanism	Rack and pinion design.
Mounting	Regular, parallel and over-door.

Ordering Information

Model	Part Number	Finish
Standard Arm	2024SIL	Silver
Standard Arm with BC	2024BCSIL	Silver
Hold open	2024HSIL	Silver
Offset arm	2024BCOPSIL	Silver

Standards and Compliance



The Lockwood 2024 series closer has been successfully tested up to four hours (depending on type of doorset) on fire door assemblies in accordance with Australian Standard AS1905.1:2005, Part: Fire Resistant Door sets.

Note: Hold open option is not approved on any fire door.

2024 Series Door Closer

2024 Standard Arm

Part Numbers

2024SIL

2024BCSIL

2024HSIL

Closer installed on pull side of door. Standard mounting position permits door opening of 180°. If hold-open is installed the hold-open range is 80° to 165°.

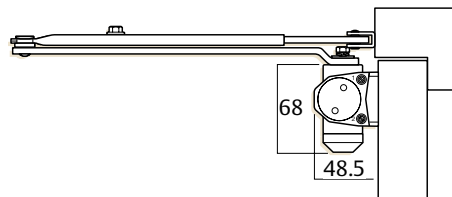
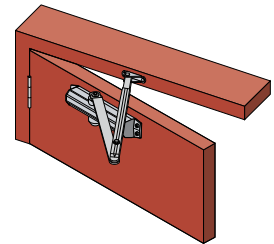
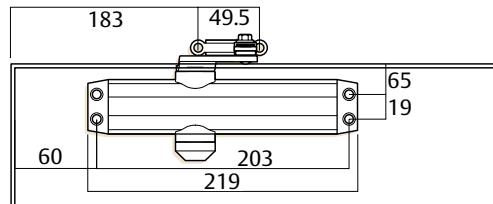

2024 Parallel Arm

Part Numbers

2024SIL

2024BCSIL

2024HSIL

Closer installed on push side of door. Standard mounting position permits door opening of 180°. If hold-open is installed the hold-open range is 80° to 165°.

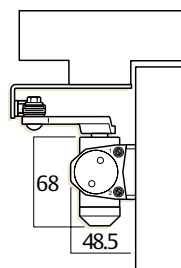
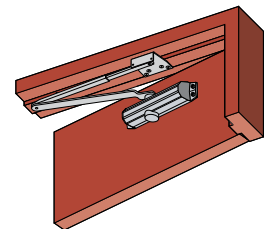
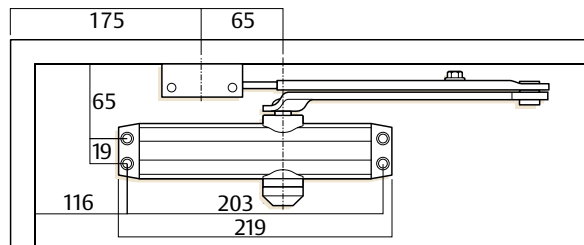

2024 Series Door Closer

2024 Over Door Mounting

Part Numbers

2024SIL

2024BCSIL

2024HSIL

Closer installed on push side top rail where door conditions do not allow parallel mounting. Standard mounting position permits door opening of 180°. If hold-open is installed the hold-open range is 80° to 165°.

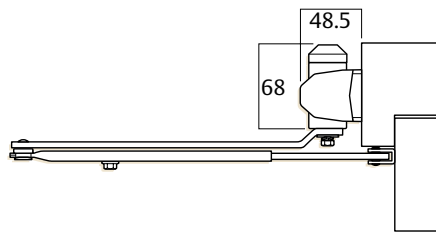
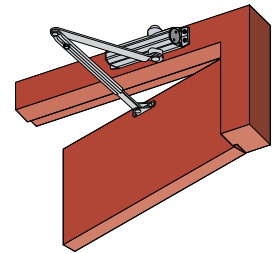
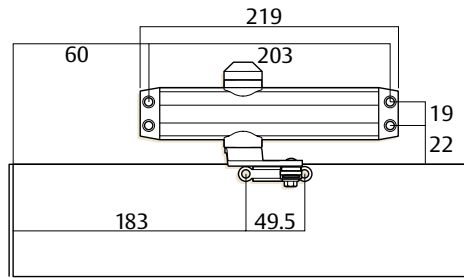

2024 Metal Door Mounting

Part Numbers

2024BCPOSIL

Closer installed on push side of door to suit doorstop of 15 mm. Standard mounting position permits door opening of 180°. If hold-open is installed the hold-open range is 90° to 165°.

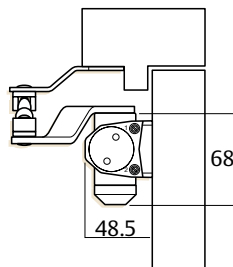
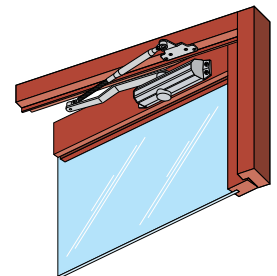
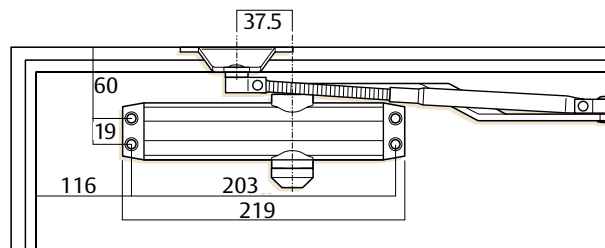

Standard Hold-Open Arm

7726 Hold Open Arm

Part Number SP7726-224SIL

7714/724 Hold Open Arm

Part Number SP7714-224SIL

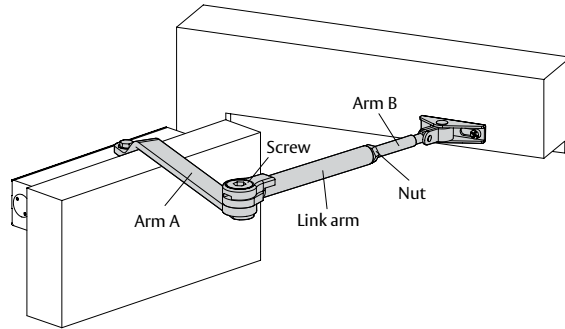

- Surface mounted on push or pull side of door
- To hold the door open at any angle until the hold-open function is positively released by a slight pull action
- Adjustable up to 150° angle of the door closer opening range

Features and Specifications

The hold-open arm is suitable for both standard and parallel mounting.

The link arm is forged steel with a steel main arm finished in baked enamel.

7726/7714/724 Slide Arm Hold Open Block

Part Number SP7726-432

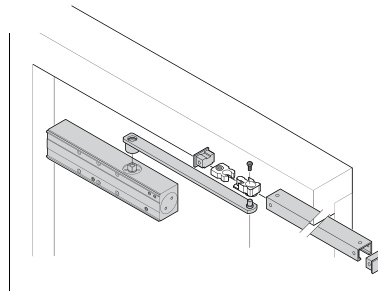

Adjustable Hold-Open Device

To set the hold-open angle move hold-open device to required position and firmly tighten screw.

If hold-open is not required do not tighten HO screw.

Delayed Action

The delayed action is an independent valve and can either be adjusted as part of the closing sequence or independently adjusted for delayed action.

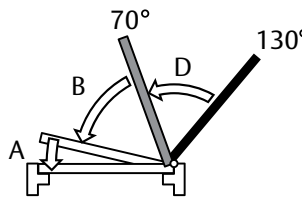

Closing Sequence with Delayed Action

D = 130° - 70° Control door speed with delayed action valve

B = 70° - 15° Control door speed with closing valve

A = 15° - 0° Control door speed with latching valve

Standard Drop Plates

7726/7714 Drop Plate

Part Number 7726-180SIL

Drop plate is available for fixing to doors with a small top rail. Four drilled and tapped holes are provided for easy installation of door closer.

Fitting of drop plate does not lower the position of door closer.

Suitable for Parallel Arm and Slide Arm. Push side applications only.

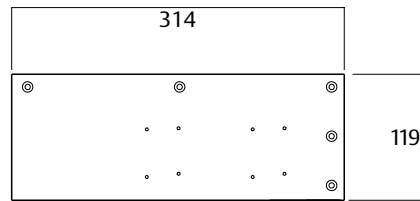

7724 Drop Plate

Part Number 7724-180SIL

Drop plate is available for fixing to doors with a small top rail. Four drilled and tapped holes are provided for easy installation of door closer.

Fitting of drop plate does not lower the position of door closer.

Suitable for Parallel Arm and Slide Arm. Push side applications only.

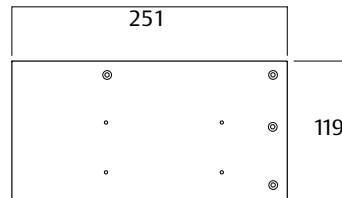

Mounting Plate

Part Number 2616-180SIL

For use on glazed doors with small top rail, this plate allows the closer to project below the top rail, at the same time concealing the back of the closer.

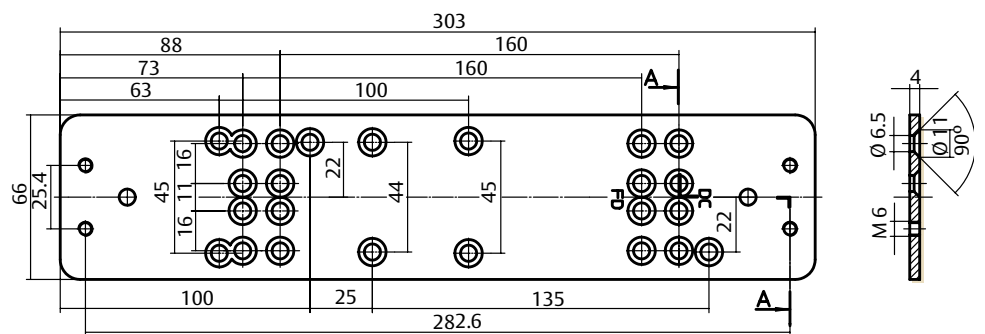

Mounting Plate

Part Number 2615-180SIL

For use on glazed doors with small top rail, this plate allows the closer to project below the top rail, at the same time concealing the back of the closer to enhance the appearance as seen through the glass.

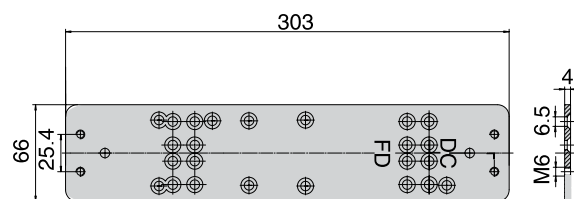

When it comes to safety it's primal, it's our survival, a basic human need. We want freedom to live, explore and rest without fear. To leave behind in safety our precious, cherished and most valuable things. And to come back to them exactly as we left them.

For as long as we have valuables, we will always need protection. Though the need for our products is driven by concerns, the Belief in our Brand is propelled by confidence. An unquestioned confidence in our ability to protect what is most important to you.

Our products provide peace of mind through strength, substance and style. Our reputation is forged in traditions, supreme workmanship, uncompromised values and above all our people. We are a trusted, tireless and vigilant guardian that protects families, households, trades and businesses.

Because if feeling safe is a basic human need, knowing you're safe is why Lockwood exists. For over 75 years, our guiding principle is and will always be: To take the worry out of protecting what is valuable to you.

Lockwood: *no worries*[®]



ASSA ABLOY

Lockwood is the leading brand in the Australasian locking industry. With a well-established reputation for high quality products, this iconic brand provides a wide range of locking solutions to residential housing, commercial building and industrial application markets.

ASSA ABLOY is the global leader in door opening solutions, dedicated to satisfying end-user needs for security, safety and convenience.

ASSA ABLOY is represented in all major regions, in both mature and emerging markets, with leading positions in New Zealand, Australia, Europe and North America.

25YEAR

**MECHANICAL
WARRANTY**

The Lockwood 25 Year Mechanical Warranty

Our belief that we manufacture the finest premium products available in today's market place is backed by the Lockwood 25 Year Mechanical Warranty, ensuring that Lockwood continues to keep Australians safe by delivering security and peace of mind.

For warranty terms and conditions, please visit www.assaabloy.co.nz/warranties

ASSA ABLOY New Zealand Ltd
6 Armstrong Road
Albany, Auckland, 0632
New Zealand

info.nz@assaabloy.com
Telephone +64 9448 9188
www.assaabloy.co.nz

